



SERVICE MANUAL ADDENDUM

IC-F6120D IC-F6122D IC-F6123D IC-F6128D

CONTENTS

REPLACEMENT PAGE	6-2, 6-3, 6-6 to 6-8, 8-1 and 8-2
PARTS LIST	1
BOARD LAYOUTS	16
VOLTAGE DIAGRAM	18

[VERSION LIST]

MODEL	VERSION	VERSION NUMBER	FREQUENCY RANGE (MHz)	CHANNEL SPACING (kHz)	TX POWER
IC-F6121D	USA-11	[#57]	400-470MHz	6.25/12.5	45W
	USA-12	[#58]	450-512MHz		
IC-F6122D	EUR-11	[#06]	400-470MHz	6.25/12.5/20.0 /25.0	25W
	DPM-01	[#21]			
	EXP-11	[#07]			
IC-F6123D	EXP-13	[#59]	450-520MHz	6.25/12.5/25.0	45W
	EXP-14	[#60]			
	EXP-16	[#61]			
	DPM-01	[#71]			
IC-F6128D	CHN-11	[#62]	400-470MHz		

ADJUSTMENT CHANNELS

Before starting the adjustments, use the cloning software to create the same cloning file as shown below, then upload it into the transceiver.

• For [Low band] versions.

Zone 1: (Left CH - 100)															(Left CH - 100)					
CH	Atr	Frequency (MHz)			TX Inh	Beat Cancel	W/N	SQL Tight	C.Tone		Text	TOT	RF PWR	PWR Save	Lock-out	Sc	CH Type	Auto Reset	Signaling	
		RX	TX	Inh					RX	TX									Log-out	Emg-out
1- 1	AB	400.000000	<-		OFF	W				LK (RX)		L1				Analog	Tim-B	DTMF	DTMF	
1- 2		470.000000	<-		OFF	W				LK (TX)		L1				Analog	Tim-B	DTMF	DTMF	
1- 3		435.000000	<-		OFF	W				Power H.		H				Analog	Tim-B	DTMF	DTMF	
1- 4		435.000000	<-		OFF	W				Power L2		L2				Analog	Tim-B	DTMF	DTMF	
1- 5		435.000000	<-		OFF	W				Power L1		L1				Analog	Tim-B	DTMF	DTMF	
1- 6		400.000000	<-		OFF	W				BAL 1		L1				Analog	Tim-B	DTMF	DTMF	
1- 7		450.000000	<-		OFF	W				BAL 2		L1				Analog	Tim-B	DTMF	DTMF	
1- 8		350.000000	<-		OFF	W				BAL 3		L1				Analog	Tim-B	DTMF	DTMF	
1- 9		400.000000	<-		OFF	N				MOD N L		L1				Analog	Tim-B	DTMF	DTMF	
1- 10		435.000000	<-		OFF	N				MOD N C		L1				Analog	Tim-B	DTMF	DTMF	
1- 11		470.000000	<-		OFF	N				MOD N H		L1				Analog	Tim-B	DTMF	DTMF	
1- 12		400.000000	<-		OFF	W				MOD W L		L1				Analog	Tim-B	DTMF	DTMF	
1- 13		435.000000	<-		OFF	W				MOD W C		L1				Analog	Tim-B	DTMF	DTMF	
1- 14		470.000000	<-		OFF	W				MOD W H		L1				Analog	Tim-B	DTMF	DTMF	
1- 15		400.000000	<-		OFF	W				MOD M L		L1				Analog	Tim-B	DTMF	DTMF	
1- 16		435.000000	<-		OFF	W				MOD M C		L1				Analog	Tim-B	DTMF	DTMF	
1- 17		470.000000	<-		OFF	W				MOD M H		L1				Analog	Tim-B	DTMF	DTMF	
1- 18		400.000000	<-		OFF	W				MOD B L		L1				Digital	Tim-B	DTMF	DTMF	
1- 19		435.000000	<-		OFF	W				MOD B C		L1				Digital	Tim-B	DTMF	DTMF	
1- 20		470.000000	<-		OFF	W				MOD B H		L1				Digital	Tim-B	DTMF	DTMF	
1- 21		470.000000	<-		OFF	W				REF		L1				Analog	Tim-B	DTMF	DTMF	
1- 22		435.000000	<-		OFF	W			151.4	CTCSS		L1				Analog	Tim-B	DTMF	DTMF	
1- 23		435.000000	<-		OFF	W			007N	DTCS		L1				Analog	Tim-B	DTMF	DTMF	
1- 24		435.000000	<-		OFF	N				S.Tone		L1				Analog	Tim-B	DTMF	DTMF	
1- 25		400.000000	<-		OFF	W				BPF C AL		L1				Analog	Tim-B	DTMF	DTMF	
1- 26		400.000000	<-		OFF	W				RSSI		L1				Analog	Tim-B	DTMF	DTMF	
1- 27		470.000000	<-		OFF	W				SQL		L1				Analog	Tim-B	DTMF	DTMF	

• For [High band] versions.

Zone 1: (Left CH - 100)															(Left CH - 100)					
CH	Inh	Frequency (MHz)			TX Inh	Beat Cancel	W/N	SQL Tight	C.Tone		Text	TOT	RF PWR	PWR Save	L	Auto can	CH Type	Auto Reset	Signa	
		RX	TX	Inh					RX	TX									Log-out	Emg-out
1- 1		450.000000	<-		OFF	W				LK (RX)		L1				Analog	Tim-B	DTMF	DTMF	
1- 2		520.000000	<-		OFF	W				LK (TX)		L1				Analog	Tim-B	DTMF	DTMF	
1- 3		485.000000	<-		OFF	W				Power H.		H				Analog	Tim-B	DTMF	DTMF	
1- 4		485.000000	<-		OFF	W				Power L2		L2				Analog	Tim-B	DTMF	DTMF	
1- 5		485.000000	<-		OFF	W				Power L1		L1				Analog	Tim-B	DTMF	DTMF	
1- 6		435.000000	<-		OFF	W				BAL 1		L1				Analog	Tim-B	DTMF	DTMF	
1- 7		485.000000	<-		OFF	W				BAL 2		L1				Analog	Tim-B	DTMF	DTMF	
1- 8		375.000000	<-		OFF	W				BAL 3		L1				Analog	Tim-B	DTMF	DTMF	
1- 9		450.000000	<-		OFF	N				MOD N L		L1				Analog	Tim-B	DTMF	DTMF	
1- 10		485.000000	<-		OFF	N				MOD N C		L1				Analog	Tim-B	DTMF	DTMF	
1- 11		520.000000	<-		OFF	N				MOD N H		L1				Analog	Tim-B	DTMF	DTMF	
1- 12		450.000000	<-		OFF	W				MOD W L		L1				Analog	Tim-B	DTMF	DTMF	
1- 13		485.000000	<-		OFF	W				MOD W C		L1				Analog	Tim-B	DTMF	DTMF	
1- 14		520.000000	<-		OFF	W				MOD W H		L1				Analog	Tim-B	DTMF	DTMF	
1- 15		450.000000	<-		OFF	W				MOD M L		L1				Analog	Tim-B	DTMF	DTMF	
1- 16		485.000000	<-		OFF	W				MOD M C		L1				Analog	Tim-B	DTMF	DTMF	
1- 17		520.000000	<-		OFF	W				MOD M H		L1				Analog	Tim-B	DTMF	DTMF	
1- 18		450.000000	<-		OFF	W				MOD B L		L1				Digital	Tim-B	DTMF	DTMF	
1- 19		485.000000	<-		OFF	W				MOD B C		L1				Digital	Tim-B	DTMF	DTMF	
1- 20		520.000000	<-		OFF	W				MOD B H		L1				Digital	Tim-B	DTMF	DTMF	
1- 21		520.000000	<-		OFF	W				REF		L1				Analog	Tim-B	DTMF	DTMF	
1- 22		485.000000	<-		OFF	W			151.4	CTCSS		L1				Analog	Tim-B	DTMF	DTMF	
1- 23		485.000000	<-		OFF	W			007N	DTCS		L1				Analog	Tim-B	DTMF	DTMF	
1- 24		485.000000	<-		OFF	N				S.Tone		L1				Analog	Tim-B	DTMF	DTMF	
1- 25		450.000000	<-		OFF	W				BPF C AL		L1				Analog	Tim-B	DTMF	DTMF	
1- 26		450.000000	<-		OFF	W				RSSI		L1				Analog	Tim-B	DTMF	DTMF	
1- 27		520.000000	<-		OFF	W				SQL		L1				Analog	Tim-B	DTMF	DTMF	

• For [350 MHz band] versions.

Zone 1: (Left CH - 100)										(Left CH - 100)											
Frequency (MHz)										C. Tone		Signal									
CH	Atr	Inh	RX	TX	TX Inh	Beat Cancel	W/N	SQL Tight	RX	TX	Text	TOT	RF PWR	PWR Save	Lock out	Auto can	CH Type	Auto Reset	Log-out	E	
1- 1	AB		350.000000	<-		OFF	W				LV (RX)		L1				Analog	Tim-B	DTMF	D	
1- 2			400.000000	<-		OFF	W				LV (TX)		L1				Analog	Tim-B	DTMF	D	
1- 3			375.000000	<-		OFF	W				Power H.		H				Analog	Tim-B	DTMF	D	
1- 4			375.000000	<-		OFF	W				Power L2		L2				Analog	Tim-B	DTMF	D	
1- 5			375.000000	<-		OFF	W				Power L1		L1				Analog	Tim-B	DTMF	D	
1- 6			350.000000	<-		OFF	W				BAL 1		L1				Analog	Tim-B	DTMF	D	
1- 7			375.000000	<-		OFF	W				BAL 2		L1				Analog	Tim-B	DTMF	D	
1- 8			400.000000	<-		OFF	W				BAL 3		L1				Analog	Tim-B	DTMF	D	
1- 9			350.000000	<-		OFF	N				MOB N L		L1				Analog	Tim-B	DTMF	D	
1- 10			375.000000	<-		OFF	N				MOB N C		L1				Analog	Tim-B	DTMF	D	
1- 11			400.000000	<-		OFF	N				MOB N H		L1				Analog	Tim-B	DTMF	D	
1- 12			350.000000	<-		OFF	W				MOB W L		L1				Analog	Tim-B	DTMF	D	
1- 13			375.000000	<-		OFF	W				MOB W C		L1				Analog	Tim-B	DTMF	D	
1- 14			400.000000	<-		OFF	W				MOB W H		L1				Analog	Tim-B	DTMF	D	
1- 15			350.000000	<-		OFF	W				MOB M L		L1				Analog	Tim-B	DTMF	D	
1- 16			375.000000	<-		OFF	W				MOB M C		L1				Analog	Tim-B	DTMF	D	
1- 17			400.000000	<-		OFF	W				MOB M H		L1				Analog	Tim-B	DTMF	D	
1- 18			350.000000	<-		OFF	W				MOB B L		L1				Digital	Tim-B	DTMF	D	
1- 19			375.000000	<-		OFF	W				MOB B C		L1				Digital	Tim-B	DTMF	D	
1- 20			400.000000	<-		OFF	W				MOB B H		L1				Digital	Tim-B	DTMF	D	
1- 21			400.000000	<-		OFF	W				REF		L1				Analog	Tim-B	DTMF	D	
1- 22			375.000000	<-		OFF	W			151.4	ETCSS		L1				Analog	Tim-B	DTMF	D	
1- 23			375.000000	<-		OFF	W			007N	DTCS		L1				Analog	Tim-B	DTMF	D	
1- 24			375.000000	<-		OFF	N				S. Tone		L1				Analog	Tim-B	DTMF	D	
1- 25			350.000000	<-		OFF	W				BPF C RL		L1				Analog	Tim-B	DTMF	D	
1- 26			350.000000	<-		OFF	W				RSSI		L1				Analog	Tim-B	DTMF	D	
1- 27			400.000000	<-		OFF	W				SQL		L1				Analog	Tim-B	DTMF	D	
1- 28																					

CONVENIENT: The cloning data file for the adjustment, as described in this service manual, is attached. Right click the clip icon, and select "Save Embedded File to Disk."

• For [Low band] versions.



• For [High band] versions.



• For [350 MHz band] versions.



For [EUR] versions:

When adjusting "Deviation" in the middle band, change the bandwidth to "Middle" as shown.

The screenshot shows the radio's menu structure on the left, with 'Common' selected. The main display shows the following settings:

- Common**
 - Timer A(Sec) 30.000
 - Timer B(Sec) 10.000
 - Inactive Timer(Sec) 60.000
- TOT/Lockout**
 - TOT Timer(Sec) 30.000
 - Penalty Timer(Sec) 20.000
 - TOT ID Out OFF
 - TOT Beep OFF
 - TOT Reset Timer(Sec) OFF
 - Lockout Penalty Timer(Sec) 5.000
 - Lockout Override OFF
- PWR Save**
 - Start Timer(1st)(Sec) 20.000
 - Start Timer(2nd)(Sec) 60.000
- Others**
 - Wide Band Width Middle
 - Forced Narrow (Wide)
 - Forced Narrow Change Middle *Select "Middle"*
 - Battery Type Li-Ion
 - Battery Type Change Disable
 - SQL Tight Offset 9
 - Escalating Alarms Disable

6-3 TRANSMIT ADJUSTMENTS

- 1) Select an adjustment item using [↑]/[↓] on the PC's keyboard.
- 2) Set or modify the adjustment value as specified using [←]/[→] on the PC's keyboard, then push [ENTER].

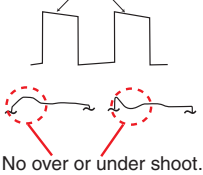
ADJUSTMENT	TRANSCEIVER'S CONDITION	OPERATION	ADJUSTMENT ITEM	VALUE	
TX OUTPUT POWER (Hi power)	1 • Channel : 1-3 • Transmitting	• Connect an RF power meter to the antenna connector.	[Power (Hi)]	45 W [45 W ver.] 25 W [25 W ver.]*	
(L2 power)	2 • Channel : 1-4 • Transmitting		[Power (L2)]	25 W [45 W ver.] 10 W [25 W ver.]*	
(L1 power)	3 • Channel : 1-5 • Transmitting		[Power (L1)]	4.5 W [45 W ver.] 2.5 W [25 W ver.]*	
MODULATION BALANCE -Band low-	1 • Set [MOD(NARROW)] to "150" on the "Adjust Utility" screen.		[MOD(NARROW)]	150	
	2 • Set [TX MODE] to "2 (Analog 100Hz Pulse)" on the "Adjust Utility" screen.		[TX MODE]	2 (Analog 100Hz Pulse)	
	3 • Push [ENTER] on the PC's keyboard, to enter the modulation balance adjustment mode.		[BAL Start]	–	
	4 • Channel : 1-6 • Transmitting	• Connect a modulation analyzer with an oscilloscope to the antenna connector, through an attenuator, and then set it as; HPF : OFF LPF : 20 kHz De-emphasis : OFF Detector : (P-P)/2	[BAL 1]	Square waveform As flat as possible. 	
	-Band center-		5 • Channel : 1-7 • Transmitting		[BAL 2]
	-Band high-		6 • Channel : 1-8 • Transmitting		[BAL 3]
	7 • Push [ENTER] on the PC's keyboard, to store the value and quit the modulation balance adjustment mode.				[BAL Start]
FM DEVIATION (Narrow mode) -Band low-	1 • Push [ENTER] on the PC's keyboard, to enter the FM deviation (For narrow mode) adjustment mode.		[MOD N Start]	–	
	2 • Channel : 1-9 • Transmitting	• Connect a modulation analyzer to the antenna connector, through an attenuator, and set it as described in the "MODULATION BALANCE" above. • Connect as audio generator to the [MIC] jack, and set it as; Frequency : 1 kHz (Sine wave) Level : 40 mVrms	[MOD N L]	±2.05 to ±2.15 kHz	
	-Band center-		3 • Channel : 1-10 • Transmitting		[MOD N C]
	-Band high-		4 • Channel : 1-11 • Transmitting		[MOD N H]
	5 • Push [ENTER] on the PC's keyboard, to store the value and quit the FM deviation (For narrow mode) adjustment mode.		[MOD N Start]	–	
(Wide mode)† -Band low-	6 • Push [ENTER] on the PC's keyboard, to enter the FM deviation (For wide mode) adjustment mode.		[MOD W Start]	–	
	7 • Channel : 1-12 • Transmitting	• Connect a modulation analyzer to the antenna connector, through an attenuator, and set it as described in the "MODULATION BALANCE" above. • Connect as audio generator to the [MIC] jack, and set it as; Frequency : 1 kHz (Sine wave) Level : 40 mVrms	[MOD W L]	±4.05 to ±4.15 kHz ±4.15 to ±4.25 kHz‡	
	-Band center-		8 • Channel : 1-13 • Transmitting		[MOD W C]
	-Band high-		9 • Channel : 1-14 • Transmitting		[MOD W H]
	10 • Push [ENTER] on the PC's keyboard, to store the value and quit the FM deviation (For wide mode) adjustment mode.		[MOD W Start]	–	
(Middle mode)‡ -Band low-	11 • Push [ENTER] on the PC's keyboard, to enter the FM deviation (For middle mode) adjustment mode.		[MOD M Start]	–	
	12 • Channel : 1-15 • Transmitting	• Connect a modulation analyzer to the antenna connector, through an attenuator, and set it as described in the "MODULATION BALANCE" above. • Connect as audio generator to the [MIC] jack, and set it as; Frequency : 1 kHz (Sine wave) Level : 40 mVrms	[MOD M L]	±3.31 to ±3.41 kHz	
	-Band center-		13 • Channel : 1-16 • Transmitting		[MOD M C]
	-Band high-		14 • Channel : 1-17 • Transmitting		[MOD M H]
	15 • Push [ENTER] on the PC's keyboard, to store the value and quit the FM deviation (For middle mode) adjustment mode.		[MOD M Start]	–	

†; For all models except [USA] ‡; For [EUR] and [DPM] versions. *; For only [Low band] versions.

6-3 TRANSMIT ADJUSTMENTS (continued)

1) Select an adjustment item using [↑]/[↓] on the PC's keyboard.

2) Set or modify the adjustment value as specified using [←]/[→] on the PC's keyboard, then push [ENTER].

ADJUSTMENT	TRANSCIVER'S CONDITION	OPERATION	ADJUSTMENT ITEM	VALUE	
DIGITAL DEVIATION (Band Low)	1	• Set [TX MODE] to "16 (Digital Max Amp 600Hz Sin Wave)" on the "Adjust Utility" screen.	[TX MODE]	16 (Digital Max Amp 600Hz Sin Wave)	
	2	• Push [ENTER] on the PC's keyboard, to enter the digital deviation adjustment mode.	[MOD D Start]	–	
	3	• Channel : 1-18 • Transmitting	• Connect a modulation analyzer to the antenna connector, through an attenuator, and set it as; HPF : OFF LPF : 20 kHz De-emphasis : OFF Detector : (P–P)/2	[MOD D L]	±1.35 to ±1.39 kHz
(Band Center)	4	• Channel : 1-19 • Transmitting		[MOD D C]	
(Band High)	5	• Channel : 1-20 • Transmitting		[MOD D H]	
	6	• Push [ENTER] on the PC's keyboard, to store the value and quit the digital deviation adjustment mode.	[MOD D Start]	–	
REFERENCE FREQUENCY	1	• Channel : 1-21 • Transmitting	[REF]	470.000000 MHz* 520.000000 MHz** 400.000000 MHz*** (±250 Hz)	
CTCSS DEVIATION	1	• Channel : 1-22 • Transmitting	[CTCSS]	±0.65 to ±0.75 kHz Except [USA] ±0.30 to ±0.40 kHz [USA]	
DTCS DEVIATION	1	• Channel : 1-23 • Transmitting	[DTCS]		
2/5 TONE, DTMF DEVIATION	1	• Set the TX Mode to "5 (Analog DTMF "D" Tone)" on the "Adjust Utility" screen.	[TX MODE]	5 (Analog DTMF "D" Tone)	
	2	• Channel : 1-24 • Transmitting	[S.Tone]	±1.45 to ±1.55 kHz	

*; [Low band] versions.

**; [High band] versions.

***; [350 MHz band] versions.

6-4 RECEIVE ADJUSTMENTS

- 1) Select an adjustment item using [↑]/[↓] on the PC's keyboard.
- 2) Set or modify the adjustment value as specified using [←]/[→] on the PC's keyboard, then push [ENTER].

ADJUSTMENT	TRANSCEIVER'S CONDITION	OPERATION	ADJUSTMENT ITEM	VALUE	
RX SENSITIVITY	1	NOTE: When "RX SENSITIVITY" is re-adjusted, "S-METER" must be re-adjusted too.			
		<ul style="list-style-type: none"> • Channel : 1-25 • Receiving 	<ul style="list-style-type: none"> • Set the SSG to the antenna connector and set it as; Frequency : 400.000 MHz* <li style="padding-left: 20px;">450.000 MHz** <li style="padding-left: 20px;">350.000 MHz*** Level† : +20 dBμ (-87 dBm) Modulation : 1 kHz Deviation : ±3.0 kHz (Except [USA]) <li style="padding-left: 20px;">±1.5 kHz ([USA]) 	[BPF C ALL]	Push [ENTER].
S-METER (S3 level setting)	1	NOTE: When "RX SENSITIVITY" must be adjusted before "S-METER." And when "RX SENSITIVITY" is re-adjusted, "S-METER" must be re-adjusted too.			
		<ul style="list-style-type: none"> • Channel : 1-26 • Receiving 	<ul style="list-style-type: none"> • Connect the SSG to the antenna connector and set as; Frequency : 400.000 MHz* <li style="padding-left: 20px;">450.000 MHz** <li style="padding-left: 20px;">350.000 MHz*** Level† : +23 dBμ (-84 dBm) Modulation : None 	[RSSI S3 Level]	Push [ENTER].
	(S3 level setting)	2	<ul style="list-style-type: none"> • Set the SSG to the antenna connector and set it as; Frequency : 400.000 MHz* <li style="padding-left: 20px;">450.000 MHz** <li style="padding-left: 20px;">350.000 MHz*** Level† : -7 dBμ (-114 dBm) Modulation : None 	[RSSI S1 Level]	
SQUELCH	1	NOTE: When "RX SENSITIVITY" must be adjusted before "SQUELCH." And when "RX SENSITIVITY" is re-adjusted, "SQUELCH" must be re-adjusted too.			
		<ul style="list-style-type: none"> • Channel : 1-27 • Receiving 	<ul style="list-style-type: none"> • Set the SSG to the antenna connector and set it as; Frequency : 470.000 MHz* <li style="padding-left: 20px;">520.000 MHz** <li style="padding-left: 20px;">400.000 MHz*** Level† : -14 dBμ (-121 dBm) Modulation : 1 kHz Deviation : ±3.00 kHz (Except [USA]) <li style="padding-left: 20px;">±1.50 kHz ([USA]) 	-	-
	2	<ul style="list-style-type: none"> • Once close the squelch by increasing [SQL] value, then decrease the value to open the squelch. 		[SQL]	Push [ENTER].

†; The output level of the standard signal generator (SSG) is indicated as the SSG's terminated circuit.

*; [Low band] versions.

**; [High band] versions.

***; [350 MHz band] versions.

SECTION 8 MECHANICAL PARTS

[CHASSIS PARTS]

REF NO.	ORDER NO.	DESCRIPTION	QTY.
J1	6510004881	MR-DSE-01-1 <GA>	1
W1	8900011801	OPC-1199A <KN>	1
MP1	8010019067	2601 CHASSIS-7	[#06] 1
	8010019067	2601 CHASSIS-7	[#07] 1
	8010019067	2601 CHASSIS-7	[#21] 1
	8010019138	2601 LONG CHASSIS-8	[#57] 1
	8010019138	2601 LONG CHASSIS-8	[#58] 1
	8010019138	2601 LONG CHASSIS-8	[#59] 1
	8010019138	2601 LONG CHASSIS-8	[#60] 1
	8010019138	2601 LONG CHASSIS-8	[#61] 1
	8010019138	2601 LONG CHASSIS-9 <STM>	[#62] 1
	8010019139	2601 LONG CHASSIS-9 <STM>	[#71] 1
	MP2	8110007821	2601 COVER-1 R
MP3	8810008661	PHBT M3 X 8 NI-ZC3	8
MP4	8810008661	PHBT M3 X 8 NI-ZC3	2
MP5	8810008661	PHBT M3 X 8 NI-ZC3	2
MP6	8810008661	PHBT M3 X 8 NI-ZC3	1
MP7	8810009991	PHBT M3 X 8 NI-ZK3	4
MP8	8810009991	PHBT M3 X 8 NI-ZK3	2

[FRONT UNIT]

REF NO.	ORDER NO.	DESCRIPTION	QTY.
MP1	8210025591	3179 FRONT PANEL ASSEMBLY-1	1
MP3	8510019360	3179 SHIELD PLATE Y1149	[#06] 1
	8510019440	3179 SHIELD PLATE ASSEMBLY1151	[#07] 1
	8510019360	3179 SHIELD PLATE Y1149	[#21] 1
	8510019440	3179 SHIELD PLATE ASSEMBLY1151	[#57] 1
	8510019440	3179 SHIELD PLATE ASSEMBLY1151	[#58] 1
	8510019440	3179 SHIELD PLATE ASSEMBLY1151	[#59] 1
	8510019440	3179 SHIELD PLATE ASSEMBLY1151	[#60] 1
	8510019440	3179 SHIELD PLATE ASSEMBLY1151	[#61] 1
	8510019440	3179 SHIELD PLATE ASSEMBLY1151	[#62] 1
	8510019440	3179 SHIELD PLATE ASSEMBLY1151	[#71] 1
	MP5	8930081250	3179 KEYBOARD (A) <SEP>
MP6	8610014010	KNOB N-386	1
MP8	8930059090	2622 LCD PLATE Y658	1
MP9	8210019350	2622 REFLECTOR	1
MP10	8930059100	2622 LCD FILTER	1
MP11	8930059000	2601 SP NET	1
MP12	8930070850	2979 VOL RUBBER (TOT)	1
MP13	8810008761	PHBT M2 X 8 NI-ZC3	3
MP14	8930059380	SHIELD SPONGE (X)	[#06] 1
	8930059380	SHIELD SPONGE (X)	[#21] 1
J1	6450002210	3017-8821 <KIN>	1
J2*	6510027960	04-6294-040-000-800+	1
DS11	5030003390	TAK-35877 FX-3331<ITAK>0	1
SP1	2510001221	C052SB500-14 <OSC>	1
W1	8900010503	OPC-1046B-1 (P0.5N40L55)	1
EP2	8930059170	SRCN-2622-SP-N-W (SHJ)	1

[MAIN-D UNIT] (For [Low band] versions)

REF NO.	ORDER NO.	DESCRIPTION	QTY.
J1001*	6510014961	B2B-ZR-SM4-TF (LF) (SN)	1
J1002	6450000140	HSJ0807-01-010	1
J1003*	6510022891	B13B-ZR-SM4-TF (LF) (SN)	1
J1004*	6510027960	04-6294-040-000-800+	1
S1001*	2260003180	MINISMDC050F-2 CN <UDX>	1
W1	7030012290	RDS2T0R0	1
W2	8900011863	OPC-1195C	1
EP4*	6910010280	HF70BB9.5X10.4X4.9	1
EP5*	6910010280	HF70BB9.5X10.4X4.9	1
EP14*	6910011560	HF70BB4.5X5X1.6	1
EP15*	6910011560	HF70BB4.5X5X1.6	1
MP1*	8510019340	3179 VCO CASE Y1142	1
MP2	8510019350	3179 VCO COVER Y1143	1
MP3	8510015110	2602 M-PLATE Y660	1
MP4*	8930055841	2490 EARTH SPRING-1	1
MP5	8510014910	2601 FILTER CASE	1
MP6	8510020540	3331 B-SHIELD PLATE Y1272	1
MP7*	8930058170	SHIELD SPONGE (O)	1
MP9	8930059390	SHIELD SPONGE (Y)	1
MP10	8930083380	3331 AF SHEET (TC-30CG-AV)	1

[MAIN-E UNIT] (For [High band] versions)

REF NO.	ORDER NO.	DESCRIPTION	QTY.
J1001*	6510014961	B2B-ZR-SM4-TF (LF) (SN)	1
J1002	6450000140	HSJ0807-01-010	1
J1003*	6510022891	B13B-ZR-SM4-TF (LF) (SN)	1
J1004*	6510027960	04-6294-040-000-800+	1
S1001*	2260003180	MINISMDC050F-2 CN <UDX>	1
W1*	7030012290	RDS2T0R0	1
W2	8900011863	OPC-1195C	1
EP4*	6910010280	HF70BB9.5X10.4X4.9	1
EP5*	6910010280	HF70BB9.5X10.4X4.9	1
MP1*	8510019340	3179 VCO CASE Y1142	1
MP2	8510019350	3179 VCO COVER Y1143	1
MP3	8510015110	2602 M-PLATE Y660	1
MP4	8930055841	2490 EARTH SPRING-1	1
MP5	8510014910	2601 FILTER CASE	1
MP6	8510020540	3331 B-SHIELD PLATE Y1272	1
MP7	8930058170	SHIELD SPONGE (O)	1
MP9	8930059390	SHIELD SPONGE (Y)	1
MP10	8930083380	3331 AF SHEET (TC-30CG-AV)	1

[MAIN-F UNIT] (For [350 MHz band] versions)

REF NO.	ORDER NO.	DESCRIPTION	QTY.
J1001*	6510014961	B2B-ZR-SM4-TF (LF) (SN)	1
J1002	6450000140	HSJ0807-01-010	1
J1003*	6510022891	B13B-ZR-SM4-TF (LF) (SN)	1
J1004*	6510027960	04-6294-040-000-800+	1
S1001*	2260003180	MINISMDC050F-2 CN <UDX>	1
W1*	7030012290	RDS2T0R0	1
W2	8900011863	OPC-1195C	1
EP4*	6910010280	HF70BB9.5X10.4X4.9	1
EP5*	6910010280	HF70BB9.5X10.4X4.9	1
MP1*	8510019340	3179 VCO CASE Y1142	1
MP2	8510019350	3179 VCO COVER Y1143	1
MP3	8510015110	2602 M-PLATE Y660	1
MP4	8930055841	2490 EARTH SPRING-1	1
MP5	8510014910	2601 FILTER CASE	1
MP6	8510020540	3331 B-SHIELD PLATE Y1272	1
MP9	8930059390	SHIELD SPONGE (Y)	1
MP10	8930083380	3331 AF SHEET (TC-30CG-AV)	1
MP12*	8930072270	SHIELD SPONGE (BV)	1

[ACCESSORIES]

REF NO.	ORDER NO.	DESCRIPTION	QTY.	
MC1	(Optional)	HM-152	[#06] 1	
	(Optional)	HM-152	[#07] 1	
	(Optional)	HM-152	[#21] 1	
	(Optional)	HM-152	[#57] 1	
	(Optional)	HM-152	[#58] 1	
	(Optional)	HM-152	[#59] 1	
	(Optional)	HM-152	[#60] 1	
	(Optional)	HM-152	[#61] 1	
	(Optional)	HM-152	[#62] 1	
	(Optional)	HM-152	[#71] 1	
	W1	(Optional)	OPC-1194A	[#06] 1
		(Optional)	OPC-1194A	[#07] 1
		(Optional)	OPC-1194A	[#21] 1
(Optional)		OPC-1132A	[#57] 1	
(Optional)		OPC-1132A	[#58] 1	
(Optional)		OPC-1132A	[#59] 1	
(Optional)		OPC-1132A	[#60] 1	
(Optional)		OPC-1132A	[#61] 1	
(Optional)		OPC-1132A	[#62] 1	
(Optional)		OPC-1132A	[#71] 1	
W2		8900000731	OPC-049A	1
MP1	8010019151	2601 MOBIL BRACKET-1	1	
MP3	8820000530	FLANGE BOLT M4 X 8 NI	4	
MP4	8810000471	PH M5 X12 (+) ZC3	4	
MP5	8810005841	PHA M5 X20 ZC3	4	
MP6	8850000150	FLAT WASHER M 5 NI BS	4	
MP7	8850000391	S-WASHER M5 ZC3	4	
MP8	8830000121	NUT M 5 ZC3	4	
MP9	8950005110	2289 MIC HANGER Y468	1	
MP11	8810004700	PHA M3 X16 SUS	2	

*: Refer to "BOARD LAYOUTS" for the location.

Screw abbreviations A, B0, BT: Self-tapping PH: Pan head ZK: Black NI-ZU: Nickel-Zinc SUS: Stainless

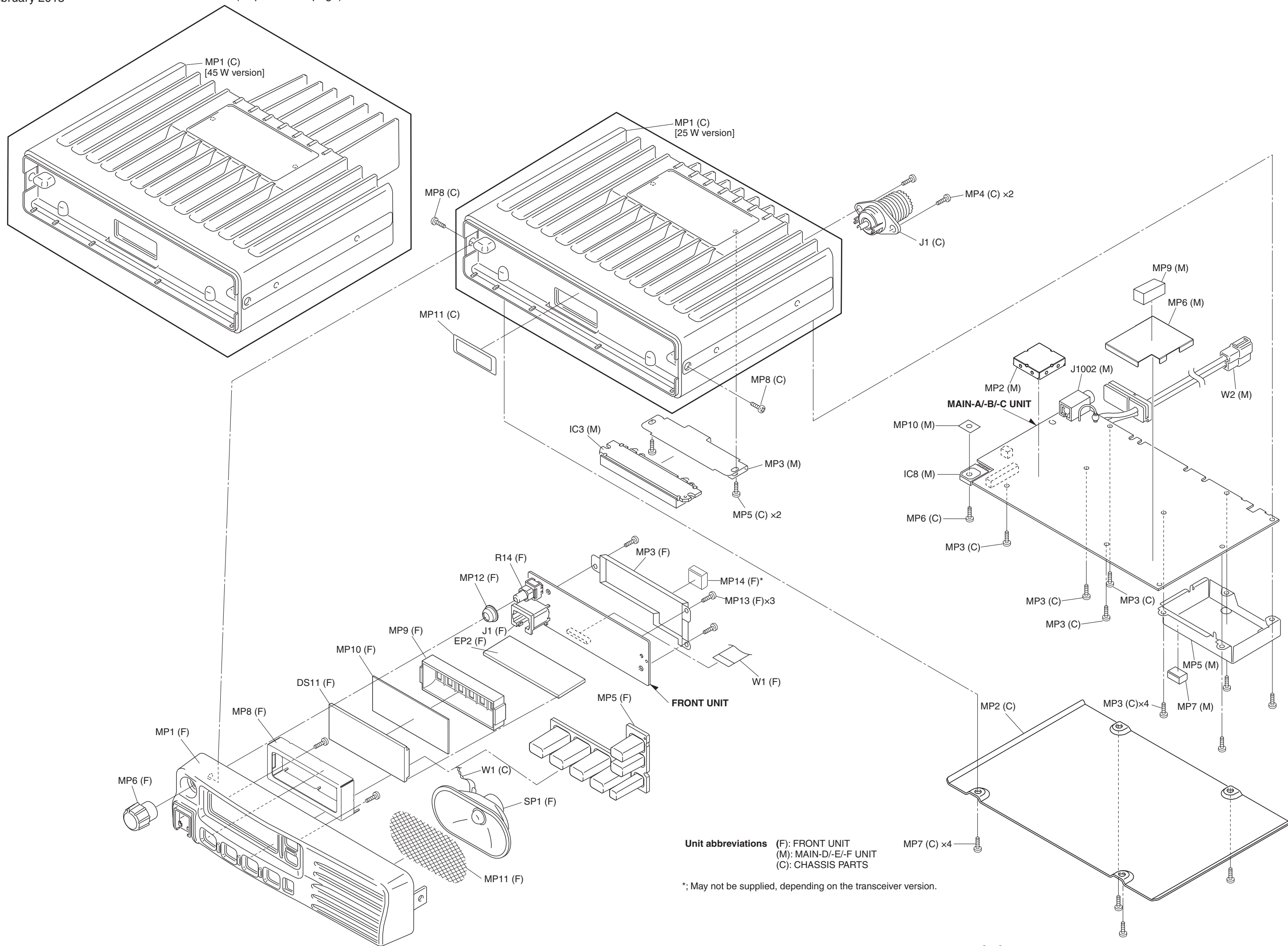

PARTS LIST

[FRONT UNIT]

REF NO.	PARTS NO.	DESCRIPTION	M.	H/V LOCATION
IC6	1130015530	S.IC BU9795AKV-E2	B	43.0/21.2
IC7	1110002751	S.IC TA75S01F(TE85RF)	B	28.3/24.7
IC51	1140015010	S.IC HD64F2506RBR26DV(EMPTY)	B	67.5/21.9
IC52	1130015080	S.IC R1EX24512ASAS0A	B	92.3/15.4
IC54	1130007021	S.IC TC7S66FU(TE85LF)	B	28.8/19.5
Q1	1530002851	S.TRA 2SC4116-BL(TE85RF)	B	33.6/16.2
Q2	1590004090	S.TRA LDTC114YET1G <SLVJ>	B	33.7/19.8
Q5	1590004090	S.TRA LDTC114YET1G <SLVJ>	B	33.7/22.3
Q10	1590004090	S.TRA LDTC114YET1G <SLVJ>	B	54.1/21.1
Q95	1590004090	S.TRA LDTC114YET1G <SLVJ>	B	77.6/11.2
Q96	1590004150	S.TRA DRC9114TOL	B	17.1/12.8
Q97	1590004150	S.TRA DRC9114TOL	B	30.7/21.5
D1	1790001990	S.VAR EZJP0V080DA	T	12.4/17.1
D2	1790001990	S.VAR EZJP0V080DA	T	7.0/17.1
D3	1790001990	S.VAR EZJP0V080DA	B	17.7/10.6
D5	1750002170	S.DIO DB2S31400L	B	48.6/6.3
D60	1750000571	S.DIO 1SS381(TPH3F)	B	80.2/13.0
Eqv.	1750001700	S.DIO HSC277TRF-E		
Eqv.	1750001790	S.DIO 1SS390 TE61		
Eqv.	1750002480	S.DIO 1SS390 <KMC>		
X51	6050013160	S.XTA CR-912 TSS3225A 19.6608 Mhz	B	84.0/16.9
L1	6200003640	S.COI MLF1608E 100K-T	B	11.6/17.1
L2	6200001981	S.COI NLV25T-1R0J	B	58.5/9.5
R7	7030005000	S.RES ERJ2GEJ 471 X (470)	B	35.7/16.2
R8	7030005000	S.RES ERJ2GEJ 471 X (470)	B	36.7/16.2
R9	7030007570	S.RES ERJ2GEJ 122 X (1.2K)	B	37.6/16.2
R11	7030009280	S.RES ERJ2GEJ 391 X	B	33.1/18.0
R12	7030009140	S.RES ERJ2GEJ 272 X (2.7K)	B	34.7/18.0
R14	7210003330	VAR RK09D1130A1N		
R15	7030005120	S.RES ERJ2GEJ 102 X (1K)	B	7.2/17.1
R16	7030005120	S.RES ERJ2GEJ 102 X (1K)	B	15.5/12.0
R18	7030005240	S.RES ERJ2GEJ 473 X (47K)	T	5.9/17.1
R19	7030005090	S.RES ERJ2GEJ 104 X (100K)	B	18.7/12.6
R20	7030010040	S.RES ERJ2GEJ-JPW	B	29.7/7.3
R40	7030005040	S.RES ERJ2GEJ 472 X (4.7K)	B	23.0/25.4
R41	7030007340	S.RES ERJ2GEJ 153 X (15K)	B	23.0/27.4
R42	7030005240	S.RES ERJ2GEJ 473 X (47K)	B	26.9/27.8
R43	7030007350	S.RES ERJ2GEJ 393 X (39K)	B	28.8/27.8
R44	7030005170	S.RES ERJ2GEJ 474 X (470K)	B	25.0/26.2
R46	7030004980	S.RES ERJ2GEJ 101 X (100)	B	33.4/3.3
R47	7030007300	S.RES ERJ2GEJ 332 X (3.3K)	B	33.4/5.1
R51	7030005090	S.RES ERJ2GEJ 104 X (100K)	B	51.0/6.3
R60	7030005090	S.RES ERJ2GEJ 104 X (100K)	B	84.0/8.6
R76	7030005120	S.RES ERJ2GEJ 102 X (1K)	T	10.4/17.1
R83	7030005090	S.RES ERJ2GEJ 104 X (100K)	B	40.0/14.7
R85	7030005090	S.RES ERJ2GEJ 104 X (100K)	B	57.7/27.5
R86	7030005090	S.RES ERJ2GEJ 104 X (100K)	B	56.7/25.0
R87	7030005090	S.RES ERJ2GEJ 104 X (100K)	B	59.1/28.1
R88	7030005090	S.RES ERJ2GEJ 104 X (100K)	B	56.3/6.9
R89	7030005090	S.RES ERJ2GEJ 104 X (100K)	B	86.9/19.8
R90	7030005090	S.RES ERJ2GEJ 104 X (100K)	B	86.2/26.0
R243	7030005530	S.RES ERJ2GEJ 100 X (10)	B	80.5/18.4
R244	7030005160	S.RES ERJ2GEJ 105 X (1M)	B	81.9/17.9
R627	7030005090	S.RES ERJ2GEJ 104 X (100K)	B	74.8/17.5
R628	7030005090	S.RES ERJ2GEJ 104 X (100K)	B	58.1/5.6
R631	7030005050	S.RES ERJ2GEJ 103 X (10K)	B	80.8/15.5
R632	7030005050	S.RES ERJ2GEJ 103 X (10K)	B	81.7/13.7
R633	7030005040	S.RES ERJ2GEJ 472 X (4.7K)	B	77.6/12.7
R635	7030005050	S.RES ERJ2GEJ 103 X (10K)	B	86.0/11.0
R636	7030005050	S.RES ERJ2GEJ 103 X (10K)	B	86.6/9.8
R637	7030005120	S.RES ERJ2GEJ 102 X (1K)	B	55.0/24.4
R638	7030005090	S.RES ERJ2GEJ 104 X (100K)	B	77.8/23.8
R639	7030005090	S.RES ERJ2GEJ 104 X (100K)	B	76.6/16.3
R651	7030005120	S.RES ERJ2GEJ 102 X (1K)	B	88.4/9.8
R652	7030005120	S.RES ERJ2GEJ 102 X (1K)	B	70.9/29.6
R657	7030005120	S.RES ERJ2GEJ 102 X (1K)	B	86.0/12.2
R688	7030005120	S.RES ERJ2GEJ 102 X (1K)	B	81.8/22.3
R763	7410001150	S.ARR EXB28V471JX	B	76.0/14.5
R765	7410001130	S.ARR EXB28V102JX	B	63.1/29.6
R767	7410001130	S.ARR EXB28V102JX	B	59.2/24.8
R768	7410001130	S.ARR EXB28V102JX	B	59.2/21.7
R769	7410001130	S.ARR EXB28V102JX	B	59.3/18.0
R770	7410001130	S.ARR EXB28V102JX	B	75.8/26.3
R771	7410001130	S.ARR EXB28V102JX	B	69.4/12.7
R772	7410001130	S.ARR EXB28V102JX	B	77.3/19.1
R773	7030005120	S.RES ERJ2GEJ 102 X (1K)	B	83.4/28.7
R774	7030005120	S.RES ERJ2GEJ 102 X (1K)	B	86.5/23.2
R775	7030005090	S.RES ERJ2GEJ 104 X (100K)	B	59.2/5.6
R776	7030005090	S.RES ERJ2GEJ 104 X (100K)	B	56.0/19.8
R777	7030005090	S.RES ERJ2GEJ 104 X (100K)	B	82.3/23.8
R778	7030005090	S.RES ERJ2GEJ 104 X (100K)	B	76.5/17.2
R779	7030005090	S.RES ERJ2GEJ 104 X (100K)	B	67.3/29.3
R780	7030005210	S.RES ERJ2GEJ 822 X (8.2K)	B	23.0/29.4
R781	7030007340	S.RES ERJ2GEJ 153 X (15K)	B	23.0/28.4
R782	7030005090	S.RES ERJ2GEJ 104 X (100K)	B	75.6/22.7
R783	7030005090	S.RES ERJ2GEJ 104 X (100K)	B	58.5/29.4
R784	7030005240	S.RES ERJ2GEJ 473 X (47K)	B	26.5/18.8
R785	7030005240	S.RES ERJ2GEJ 473 X (47K)	B	30.8/19.3

Eqv.= This component is equivalent to the REF No. component listed above, and may be substituted on parts orders and repairs.

[FRONT UNIT]

REF NO.	PARTS NO.	DESCRIPTION	M.	H/V LOCATION
R786	7030010040	S.RES ERJ2GEJ-JPW	B	74.8/28.3
C2	4030017420	S.CER C1005 CH 1H 470J-T	B	84.0/7.7
C3	4030017420	S.CER C1005 CH 1H 470J-T	B	28.5/6.1
C4	4030017420	S.CER C1005 CH 1H 470J-T	B	47.2/5.0
C5	4030017420	S.CER C1005 CH 1H 470J-T	B	56.3/4.6
C8	4030017460	S.CER C1005 JB 1H 102K-T	B	13.7/17.1
C9	4030017460	S.CER C1005 JB 1H 102K-T	T	11.3/17.1
C10	4030017460	S.CER C1005 JB 1H 102K-T	T	20.3/13.1
C12	4030017460	S.CER C1005 JB 1H 102K-T	T	18.3/13.1
C25	4030016790	S.CER C1005 JB 1E 103K-T	B	26.9/28.9
C26	4030016930	S.CER C1005 JB 1A 104K-T	B	23.0/26.4
C27	4030018010	S.CER C1005 CH 1H 360J-T	B	25.0/27.1
C28	4030016930	S.CER C1005 JB 1A 104K-T	B	30.6/27.1
C31	4030016930	S.CER C1005 JB 1A 104K-T	B	33.4/4.2
C34	4030017420	S.CER C1005 CH 1H 470J-T	B	56.3/5.5
C41	4030017460	S.CER C1005 JB 1H 102K-T	B	25.0/29.0
C50	4030017420	S.CER C1005 CH 1H 470J-T	B	61.6/8.6
C75	4030016930	S.CER C1005 JB 1A 104K-T	B	43.8/14.7
C76	4030016930	S.CER C1005 JB 1A 104K-T	B	28.8/28.9
C78	4030017460	S.CER C1005 JB 1H 102K-T	B	8.9/17.1
C84	4030017420	S.CER C1005 CH 1H 470J-T	B	29.9/2.9
C87	4030016930	S.CER C1005 JB 1A 104K-T	B	30.9/18.0
C93	4030017460	S.CER C1005 JB 1H 102K-T	B	56.3/7.9
C114	4030017420	S.CER C1005 CH 1H 470J-T	B	19.7/10.6
C126	4030017460	S.CER C1005 JB 1H 102K-T	B	25.2/4.2
C128	4030016930	S.CER C1005 JB 1A 104K-T	T	14.6/19.3
C129	4030017460	S.CER C1005 JB 1H 102K-T	T	13.7/19.3
C130	4030017460	S.CER C1005 JB 1H 102K-T	B	85.7/8.6
C131	4030017460	S.CER C1005 JB 1H 102K-T	B	86.9/21.0
C132	4030017460	S.CER C1005 JB 1H 102K-T	B	86.2/26.9
C626	4030017640	S.CER C1005 CH 1H 150J-T	B	81.1/19.6
C627	4030017580	S.CER C1005 CH 1H 060C-T	B	80.0/17.0
C628	4030017640	S.CER C1005 CH 1H 150J-T	B	81.0/17.0
C629	4030016930	S.CER C1005 JB 1A 104K-T	B	79.4/15.1
C630	4030016930	S.CER C1005 JB 1A 104K-T	B	76.2/12.3
C631	4030016930	S.CER C1005 JB 1A 104K-T	B	56.1/29.6
C797	4030016930	S.CER C1005 JB 1A 104K-T	B	75.6/21.5
C799	4030016930	S.CER C1005 JB 1A 104K-T	B	77.2/22.4
C800	4030016930	S.CER C1005 JB 1A 104K-T	B	72.2/21.1
C802	4030016930	S.CER C1005 JB 1A 104K-T	B	64.7/9.9
C803	4030019990	S.CER C1005 JB 1C 104K-T	B	49.7/24.9
C804	4030017460	S.CER C1005 JB 1H 102K-T	B	26.6/22.1
C805	4030018900	S.CER C1005 JB 0J 474K-T	B	65.3/29.3
C806	4550006970	S.TAN TEESVA OG 476M8R	B	43.4/6.5
Eqv.	4550008240	S.TAN F930G476MAA		
C807	4030016930	S.CER C1005 JB 1A 104K-T	B	75.4/20.4
C808	4030016930	S.CER C1005 JB 1A 104K-T	B	78.8/17.1
C809	4030016930	S.CER C1005 JB 1A 104K-T	B	88.6/15.1
C810	4030016930	S.CER C1005 JB 1A 104K-T	B	25.0/28.1
C811	4030017460	S.CER C1005 JB 1H 102K-T	B	31.5/8.0
J1	6450002210	CON 3017-8821 <KIN>		
J2	6510027960	S.CON 04-6294-040-000-800	B	71.0/5.7
DS1	5040003510	S.LED LNJ426W83RA	T	64.8/23.5
DS2	5040003510	S.LED LNJ426W83RA	T	58.2/23.5
DS3	5040003510	S.LED LNJ426W83RA	T	51.6/23.5
DS4	5040003510	S.LED LNJ426W83RA	T	31.8/23.5
DS5	5040003510	S.LED LNJ426W83RA	T	38.4/23.5
DS6	5040003510	S.LED LNJ426W83RA	T	45.0/23.5
DS7	5040003510	S.LED LNJ426W83RA	T	82.6/22.1
DS8	5040003510	S.LED LNJ426W83RA	T	65.3/5.0
DS9	5040003510	S.LED LNJ426W83RA	T	36.3/5.0
DS11	5030003390	LCD TAK-35877 FX-3331<ITAK>		
SP1	2510001221	SPE C052SB500-14 <OSC>		
W1	8900010503	CAB OPC-1046B-1(P0.5N40L55) <TJM>		
EP2	89300059170	LCD SRCN-2622-SP-N-W (SHJ)		

M.=Mounted side (T: Mounted on the Top side, B: Mounted on the Bottom side) S.=Surface mount

[MAIN-D UNIT] (For [Low band] versions)

REF NO.	PARTS NO.	DESCRIPTION	M.	H/V LOCATION
R10	7030008010	S.RES ERJ2GGEJ 123 X (12K) [#06]	B	22.2/48.1
	7030008010	S.RES ERJ2GGEJ 123 X (12K) [#07]	B	
	7030008010	S.RES ERJ2GGEJ 123 X (12K) [#21]	B	
	7030005220	S.RES ERJ2GGEJ 223 X (22K) [#57]	B	
	7030005220	S.RES ERJ2GGEJ 223 X (22K) [#59]	B	
	7030005220	S.RES ERJ2GGEJ 223 X (22K) [#62]	B	
	7030005220	S.RES ERJ2GGEJ 223 X (22K) [#71]	B	
R11	7030005050	S.RES ERJ2GGEJ 103 X (10K)	B	31.5/40.5
R12	7030004980	S.RES ERJ2GGEJ 101 X (100)	B	39.2/39.5
R13	7030005050	S.RES ERJ2GGEJ 103 X (10K)	B	32.5/40.5
R14	7030005050	S.RES ERJ2GGEJ 103 X (10K)	B	32.5/38.8
R15	7030005700	S.RES ERJ2GGEJ 274 X (270K)	B	39.2/38.6
R16	7030004990	S.RES ERJ2GGEJ 221 X (220)	B	39.5/40.7
R17	7030005530	S.RES ERJ2GGEJ 100 X (10)	B	51.5/40.2
R18	7030005050	S.RES ERJ2GGEJ 103 X (10K)	B	60.8/40.5
R19	7030005090	S.RES ERJ2GGEJ 104 X (100K)	B	39.2/36.8
R20	7030005120	S.RES ERJ2GGEJ 102 X (1K)	B	52.8/38.6
R21	7030005050	S.RES ERJ2GGEJ 103 X (10K)	B	54.1/40.2
R22	7030005050	S.RES ERJ2GGEJ 103 X (10K)	B	56.2/37.4
R23	7030005050	S.RES ERJ2GGEJ 103 X (10K)	B	54.1/41.2
R29	7030009200	S.RES ERJ2GGEJ 390 X (39)	B	74.0/40.6
R30	7030007300	S.RES ERJ2GGEJ 332 X (3.3K)	B	71.3/41.2
R31	7030004980	S.RES ERJ2GGEJ 101 X (100)	B	66.9/37.4
R33	7030005600	S.RES ERJ2GGEJ 273 X (27K)	T	71.9/42.7
R34	7030005110	S.RES ERJ2GGEJ 224 X (220K)	T	64.9/23.1
R35	7030005530	S.RES ERJ2GGEJ 100 X (10)	T	64.9/22.2
R36	7030007290	S.RES ERJ2GGEJ 222 X (2.2K)	B	56.2/21.7
R37	7030008410	S.RES ERJ2GGEJ 392 X (3.9K)	B	56.6/25.5
R38	7030005090	S.RES ERJ2GGEJ 104 X (100K)	T	61.7/17.8
R39	7030004970	S.RES ERJ2GGEJ 470 X (47)	B	58.4/22.2
R40	7030005030	S.RES ERJ2GGEJ 152 X (1.5K)	B	58.4/23.2
R41	7030010040	S.RES ERJ2GGEJ-JPW	T	60.8/17.8
R42	7030005070	S.RES ERJ2GGEJ 683 X (68K)	T	51.0/24.3
R43	7030005000	S.RES ERJ2GGEJ 471 X (470)	T	55.6/19.9
R44	7030005100	S.RES ERJ2GGEJ 154 X (150K)	T	54.0/24.7
R45	7030005080	S.RES ERJ2GGEJ 823 X (82K)	T	52.2/24.7
R46	7030008410	S.RES ERJ2GGEJ 392 X (3.9K)	T	54.0/22.9
R48	7030008300	S.RES ERJ2GGEJ 184 X (180K) [#57]	T	56.8/53.2
	7030008300	S.RES ERJ2GGEJ 184 X (180K) [#59]	T	
	7030008300	S.RES ERJ2GGEJ 184 X (180K) [#62]	T	
	7030008300	S.RES ERJ2GGEJ 184 X (180K) [#71]	T	
R49	7520000241	S.POS PRF18BC471QB5RB [#57]	T	47.3/53.2
	7520000241	S.POS PRF18BC471QB5RB [#59]	T	
	7520000241	S.POS PRF18BC471QB5RB [#62]	T	
	7520000241	S.POS PRF18BC471QB5RB [#71]	T	
R50	7030005050	S.RES ERJ2GGEJ 103 X (10K)	B	80.1/37.9
R51	7030008290	S.RES ERJ2GGEJ 183 X (18K) [#06]	T	61.8/49.8
	7030008290	S.RES ERJ2GGEJ 183 X (18K) [#07]	T	
	7030008290	S.RES ERJ2GGEJ 183 X (18K) [#21]	T	
	7030005080	S.RES ERJ2GGEJ 823 X (82K) [#57]	T	
	7030005080	S.RES ERJ2GGEJ 823 X (82K) [#59]	T	
	7030005080	S.RES ERJ2GGEJ 823 X (82K) [#62]	T	
	7030005080	S.RES ERJ2GGEJ 823 X (82K) [#71]	T	
R52	7030005070	S.RES ERJ2GGEJ 683 X (68K)	T	58.7/52.1
R53	7030004990	S.RES ERJ2GGEJ 221 X (220)	T	57.8/53.2
R54	7030005050	S.RES ERJ2GGEJ 103 X (10K) [#06]	B	58.8/55.7
	7030005050	S.RES ERJ2GGEJ 103 X (10K) [#07]	B	
	7030005220	S.RES ERJ2GGEJ 223 X (22K) [#57]	B	
	7030005220	S.RES ERJ2GGEJ 223 X (22K) [#59]	B	
	7030005220	S.RES ERJ2GGEJ 223 X (22K) [#62]	B	
	7030005220	S.RES ERJ2GGEJ 223 X (22K) [#71]	B	
R56	7030005110	S.RES ERJ2GGEJ 224 X (220K) [#06]	T	63.3/55.0
	7030005110	S.RES ERJ2GGEJ 224 X (220K) [#07]	T	
	7030005110	S.RES ERJ2GGEJ 224 X (220K) [#21]	T	
	7030005100	S.RES ERJ2GGEJ 154 X (150K) [#57]	T	
	7030005100	S.RES ERJ2GGEJ 154 X (150K) [#59]	T	
	7030005100	S.RES ERJ2GGEJ 154 X (150K) [#62]	T	
	7030005100	S.RES ERJ2GGEJ 154 X (150K) [#71]	T	
R57	7030005050	S.RES ERJ2GGEJ 103 X (10K)	B	58.8/54.8
R58	7030004980	S.RES ERJ2GGEJ 101 X (100)	T	64.2/55.0
R59	7030008290	S.RES ERJ2GGEJ 183 X (18K) [#06]	T	59.7/52.1
	7030008290	S.RES ERJ2GGEJ 183 X (18K) [#07]	T	
	7030008290	S.RES ERJ2GGEJ 183 X (18K) [#21]	T	
	7030007350	S.RES ERJ2GGEJ 393 X (39K) [#57]	B	
	7030007350	S.RES ERJ2GGEJ 393 X (39K) [#59]	B	
	7030007350	S.RES ERJ2GGEJ 393 X (39K) [#62]	B	
	7030007350	S.RES ERJ2GGEJ 393 X (39K) [#71]	B	
R61	7030004970	S.RES ERJ2GGEJ 470 X (47)	B	90.5/49.5
R62	7030008290	S.RES ERJ2GGEJ 183 X (18K)	B	89.6/49.5
R66	7030005090	S.RES ERJ2GGEJ 104 X (100K)	B	84.9/49.1
R67	7030004980	S.RES ERJ2GGEJ 101 X (100)	B	83.0/47.3
R68	7030005050	S.RES ERJ2GGEJ 103 X (10K)	B	82.6/48.7
R69	7030005040	S.RES ERJ2GGEJ 472 X (4.7K)	B	84.0/38.0
R70	7030004990	S.RES ERJ2GGEJ 221 X (220)	B	92.8/35.8
R71	7030007260	S.RES ERJ2GGEJ 330 X (33)	B	95.3/33.8
R72	7030004980	S.RES ERJ2GGEJ 101 X (100)	B	86.5/49.1
R73	7030005000	S.RES ERJ2GGEJ 471 X (470)	B	99.5/35.3
R74	7030005080	S.RES ERJ2GGEJ 823 X (82K)	B	101.3/33.7
R75	7030006610	S.RES ERJ2GGEJ 394 X (390K)	B	97.6/32.2
R76	7030009270	S.RES ERJ2GGEJ 821 X (82)	B	96.7/32.2
R77	7030005120	S.RES ERJ2GGEJ 102 X (1K)	T	106.6/36.1
R78	7030008370	S.RES ERJ2GGEJ 561 X (560)	T	102.5/32.5
R79	7030006020	S.RES RR0510P-682-D (6.8K)	B	96.5/23.7
R80	7030009270	S.RES ERJ2GGEJ 821 X (82)	T	100.0/32.5
R83	7030006020	S.RES RR0510P-682-D (6.8K)	B	106.4/29.1
R84	7030006020	S.RES RR0510P-682-D (6.8K)	B	106.4/28.2
R85	7030006020	S.RES RR0510P-682-D (6.8K)	B	95.6/25.8
R86	7030005110	S.RES ERJ2GGEJ 224 X (220K)	B	102.6/24.4
R87	7030005530	S.RES ERJ2GGEJ 100 X (10)	B	102.6/27.5
R89	7030005050	S.RES ERJ2GGEJ 103 X (10K)	T	79.0/25.0
R90	7030005170	S.RES ERJ2GGEJ 474 X (470K)	T	95.9/15.3
R92	7030005100	S.RES ERJ2GGEJ 154 X (150K)	T	94.3/14.4
R93	7030005600	S.RES ERJ2GGEJ 273 X (27K)	B	81.3/25.8
R95	7030005710	S.RES ERJ2GGEJ 121 X (12K)	B	83.8/24.5

Eqv.= This component is equivalent to the REF No. component listed above, and may be substituted on parts orders and repairs.

[MAIN-D UNIT] (For [Low band] versions)

REF NO.	PARTS NO.	DESCRIPTION	M.	H/V LOCATION
R96	7030007290	S.RES ERJ2GGEJ 222 X (2.2K)	B	83.8/23.5
R97	7030010040	S.RES ERJ2GGEJ-JPW	B	82.2/24.5
R98	7030007290	S.RES ERJ2GGEJ 222 X (2.2K)	T	109.5/33.8
R100	7030005240	S.RES ERJ2GGEJ 473 X (47K)	T	76.1/20.3
R101	7030004980	S.RES ERJ2GGEJ 101 X (100)	T	77.9/22.2
R123	7030005530	S.RES ERJ2GGEJ 100 X (10)	T	68.2/40.4
R125	7030008370	S.RES ERJ2GGEJ 561 X (560)	T	65.6/29.2
R171	7030004980	S.RES ERJ2GGEJ 101 X (100)	T	45.5/28.6
R172	7030008300	S.RES ERJ2GGEJ 184 X (180K)	T	44.2/27.1
R173	7030005120	S.RES ERJ2GGEJ 102 X (1K)	T	42.9/26.4
R174	7030005290	S.RES ERJ2GGEJ 682 X (6.8K)	T	42.0/28.8
R175	7030009290	S.RES ERJ2GGEJ 562 X (5.6K)	T	41.6/27.6
R176	7030005030	S.RES ERJ2GGEJ 152 X (1.5K)	T	42.0/26.4
R178	7030004970	S.RES ERJ2GGEJ 470 X (47)	B	38.4/27.0
R211	7030004970	S.RES ERJ2GGEJ 470 X (47)	T	82.7/28.3
R212	7030010040	S.RES ERJ2GGEJ-JPW	T	82.6/60.4
R234	7030005720	S.RES ERJ2GGEJ 563 X (56K)	B	92.8/34.9
R235	7030004980	S.RES ERJ2GGEJ 101 X (100)	B	81.0/37.9
R236	7030007570	S.RES ERJ2GGEJ 122 X (1.2K)	B	67.4/22.7
R237	7030007060	S.RES ERJ2GGEJ 684X (680K)	B	67.4/23.6
R289	7030008290	S.RES ERJ2GGEJ 183 X (18K)	T	95.9/12.6
R290	7030007280	S.RES ERJ2GGEJ 331 X (330)	T	63.2/23.1
R291	7030005090	S.RES ERJ2GGEJ 104 X (100K)	T	94.3/13.5
R293	7030006610	S.RES ERJ2GGEJ 394 X (390K)	T	88.4/12.0
R295	7030006610	S.RES ERJ2GGEJ 394 X (390K)	T	101.0/17.3
R299	7030008300	S.RES ERJ2GGEJ 184 X (180K)	B	74.6/38.5
R300	7030005720	S.RES ERJ2GGEJ 563 X (56K)	B	76.8/40.6
R301	7030005100	S.RES ERJ2GGEJ 154 X (150K)	B	67.5/40.3
R302	7030005720	S.RES ERJ2GGEJ 563 X (56K)	B	66.9/38.5
R308	7030009140	S.RES ERJ2GGEJ 272 X (2.7K)	B	56.9/54.9
R311	7030010040	S.RES ERJ2GGEJ-JPW	B	94.9/32.2
R317	7030005120	S.RES ERJ2GGEJ 102 X (1K)	T	103.8/36.5
R319	7030005210	S.RES ERJ2GGEJ 822 X (8.2K)	T	37.3/37.9
R320	7030005170	S.RES ERJ2GGEJ 474 X (470K)	T	35.5/36.2
R328	7030010040	S.RES ERJ2GGEJ-JPW	B	104.8/29.1
R334	7030005000	S.RES ERJ2GGEJ 471 X (470)	B	87.6/61.3
R337	7030005530	S.RES ERJ2GGEJ 100 X (10)	T	87.1/62.7
R338	7030005000	S.RES ERJ2GGEJ 471 X (470)	T	87.6/64.1
R339	7030010040	S.RES ERJ2GGEJ-JPW	B	96.5/25.3
R340	7030005050	S.RES ERJ2GGEJ 103 X (10K)	B	72.4/25.3
R350	7030005600	S.RES ERJ2GGEJ 273 X (27K)	B	59.9/26.2
R351	7030005600	S.RES ERJ2GGEJ 273 X (27K)	B	43.2/26.2
R352	7030007300	S.RES ERJ2GGEJ 332 X (3.3K)	B	50.9/26.8
R353	7030005210	S.RES ERJ2GGEJ 822 X (8.2K)	B	45.4/27.1
R354	7030005210	S.RES ERJ2GGEJ 822 X (8.2K)	B	46.5/29.0
R355	7030005000	S.RES ERJ2GGEJ 471 X (470)	B	44.4/29.4
R394	7030010040	S.RES ERJ2GGEJ-JPW	B	100.1/27.8
R395	7030010040	S.RES ERJ2GGEJ-JPW	B	26.7/46.3
R478	7030007340	S.RES ERJ2GGEJ 153 X (15K)	B	34.1/28.5
R479	7030005600	S.RES ERJ2GGEJ 273 X (27K)	T	66.8/27.4
R483	7030007300	S.RES ERJ2GGEJ 332 X (3.3K)	T	71.5/28.8
R484	7030007300	S.RES ERJ2GGEJ 332 X (3.3K)	T	76.5/42.5
R485	7030010040	S.RES ERJ2GGEJ-JPW	T	77.0/40.4
R486	7030005000	S.RES ERJ2GGEJ 471 X (470)	T	73.2/29.7
R488	7030007300	S.RES ERJ2GGEJ 332 X (3.3K)	T	68.6/42.5
R489	7030007300	S.RES ERJ2GGEJ 332 X (3.3K)	T	68.5/29.7
R490	7030005120	S.RES ERJ2GGEJ 102 X (1K)	T	81.3/42.2
R492	7030005090	S.RES ERJ2GGEJ 104 X (100K)	B	80.0/27.2
R500	7030010040	S.RES ERJ2GGEJ-JPW	T	55.0/18.7
R504	7030005090	S.RES ERJ2GGEJ 104 X (100K)	T	75.3/17.9
R505	7030005290	S.RES ERJ2GGEJ 682 X (6.8K)	T	76.1/22.7
R506	7030005050	S.RES ERJ2GGEJ 103 X (10K)	T	74.8/21.5
R613	7030005120	S.RES ERJ2GGEJ 102 X (1K)	B	81.2/39.3
R614	7030007290	S.RES ERJ2GGEJ 222 X (2.2K)	B	56.2/24.3
R615	7030005040	S.RES ERJ2GGEJ 472 X (4.7K)	T	50.7/27.7
R619	7030005030	S.RES ERJ2GGEJ 152 X (1.5K)	B	33.9/29.7
R621	7410001130	S.ARR EXB28V102JX	B	76.6/19.6
R622	7030007570	S.RES ERJ2GGEJ 122 X (1.2K)	B	83.8/21.6
R623	7030005090	S.RES ERJ2GGEJ 104 X (100K)	T	50.7/26.1
R624	7030005090	S.RES ERJ2GGEJ 104 X (100K)	T	83.2/11.6
R625	7030010040	S.RES ERJ2GGEJ-JPW	B	96.1/20.1
R1003	7030007601	S.RES ERA3YKD 913V (91K)	B	72.6/9.4
R1004	7030006101	S.RES ERA3YED 183V (18K)	B	70.2/10.2
R1005	7030005120	S.RES ERJ2GGEJ 102 X (1K)	T	112.3/16.5
R1006	7030005090	S.RES ERJ2GGEJ 104 X (100K)	B	112.4/8.1
R1008	7030010040	S.RES ERJ2GGEJ-JPW	T	124.9/24.8
R1009	7030005050	S.RES ERJ2GGEJ 103 X (10K)	T	133.3/49.2
R1010	7030005050	S.RES ERJ2GGEJ 103 X (10K)	T	128.6/23.8
R1012	7030005040	S.RES ERJ2GGEJ 472 X (4.7K)	T	110.6

[MAIN-D UNIT] (For [Low band] versions)

REF NO.	PARTS NO.	DESCRIPTION	M.	H/V LOCATION
R1043	7030005160	S.RES ERJ2GEJ 105 X (1M)	B	112.0/11.0
R1044	7030005090	S.RES ERJ2GEJ 104 X (100K)	B	117.9/9.9
R1045	7030005050	S.RES ERJ2GEJ 103 X (10K)	B	120.4/17.1
R1046	7030005800	S.RES RR0510P-102-D (1K)	B	119.7/9.0
R1047	7030005050	S.RES ERJ2GEJ 103 X (10K)	B	119.4/18.6
R1048	7030009710	S.RES ERJ2GEJ 203 X (20K)	B	119.0/22.4
R1049	7030005040	S.RES ERJ2GEJ 472 X (4.7K)	B	116.7/19.7
R1050	7030007290	S.RES ERJ2GEJ 222 X (2.2K)	B	123.1/39.7
R1054	7030008270	S.RES RR0510P-104-D (100K)	B	119.7/9.9
R1055	7030005090	S.RES ERJ2GEJ 104 X (100K)	B	120.4/15.2
R1056	7030008270	S.RES RR0510P-104-D (100K)	B	118.8/10.8
R1057	7030005100	S.RES ERJ2GEJ 154 X (150K)	B	118.8/15.2
R1059	7410001130	S.ARR EXB28V102JX	T	69.7/14.8
R1060	7410001130	S.ARR EXB28V102JX	T	63.4/14.8
R1062	7030008270	S.RES RR0510P-104-D (100K)	B	116.0/14.8
R1068	7030005120	S.RES ERJ2GEJ 102 X (1K)	T	74.3/14.1
R1069	7030005120	S.RES ERJ2GEJ 102 X (1K)	T	72.6/14.1
R1070	7030005120	S.RES ERJ2GEJ 102 X (1K)	T	57.3/15.1
R1082	7410001130	S.ARR EXB28V102JX	T	56.9/6.7
R1083	7030005120	S.RES ERJ2GEJ 102 X (1K)	B	69.1/8.8
R1084	7410001130	S.ARR EXB28V102JX	T	61.7/6.1
R1085	7030005120	S.RES ERJ2GEJ 102 X (1K)	T	65.7/7.1
R1098	7510001730	S.THE ERTJJOEP 473J	T	74.9/15.5
R1099	7030008270	S.RES RR0510P-104-D (100K)	T	72.5/15.5
R1100	7410001130	S.ARR EXB28V102JX	T	75.3/6.0
R1105	7030003860	S.RES ERJ3GE JPW V	T	127.8/48.9
R1108	7030005240	S.RES ERJ2GEJ 473 X (47K)	B	124.9/41.7
R1114	7030005120	S.RES ERJ2GEJ 102 X (1K)	T	65.7/6.2
R1115	7030005120	S.RES ERJ2GEJ 102 X (1K)	T	65.7/5.3
R1116	7030007300	S.RES ERJ2GEJ 332 X (3.3K)	T	73.7/15.0
R1119	7030003860	S.RES ERJ3GE JPW V	T	99.5/68.6
	7030003860	S.RES ERJ3GE JPW V	[#57]	
	7030003860	S.RES ERJ3GE JPW V	[#59]	
	7030003860	S.RES ERJ3GE JPW V	[#62]	
	7030003860	S.RES ERJ3GE JPW V	[#71]	
R1500	7030005310	S.RES ERJ2GEJ 124 X (120K)	T	34.0/14.3
R1501	7030005240	S.RES ERJ2GEJ 473 X (47K)	T	37.1/19.2
R1502	7030009290	S.RES ERJ2GEJ 562 X (5.6K)	T	38.0/19.2
R1503	7030008010	S.RES ERJ2GEJ 123 X (12K)	T	34.0/15.2
R1504	7030008300	S.RES ERJ2GEJ 184 X (180K)	T	31.8/16.8
R1505	7030007340	S.RES ERJ2GEJ 153 X (15K)	T	34.0/18.1
R1506	7030007340	S.RES ERJ2GEJ 153 X (15K)	T	34.0/17.2
R1507	7030005050	S.RES ERJ2GEJ 103 X (10K)	T	34.2/19.3
R1508	7030005220	S.RES ERJ2GEJ 223 X (22K)	T	30.8/17.3
R1509	7030005050	S.RES ERJ2GEJ 103 X (10K)	T	30.8/18.9
R1510	7030006610	S.RES ERJ2GEJ 394 X (390K)	T	33.3/19.3
R1515	7030008010	S.RES ERJ2GEJ 123 X (12K)	T	38.4/23.6
R1517	7030010040	S.RES ERJ2GEJ-JPW	T	35.3/19.6
R1518	7030005310	S.RES ERJ2GEJ 124 X (120K)	T	37.6/21.7
R1519	7030007350	S.RES ERJ2GEJ 393 X (39K)	T	36.2/21.2
R1521	7030010040	S.RES ERJ2GEJ-JPW	B	39.7/23.2
R1523	7030005080	S.RES ERJ2GEJ 823 X (82K)	T	42.6/17.7
R1524	7030005030	S.RES ERJ2GEJ 152 X (1.5K)	T	42.6/18.6
R1525	7030010040	S.RES ERJ2GEJ-JPW	T	42.6/19.5
R1526	7030005070	S.RES ERJ2GEJ 683 X (68K)	T	41.4/18.1
R1527	7030005090	S.RES ERJ2GEJ 104 X (100K)	B	32.9/11.9
R1529	7030005070	S.RES ERJ2GEJ 683 X (68K)	T	44.4/20.4
R1530	7030005040	S.RES ERJ2GEJ 472 X (4.7K)	B	31.6/19.6
R1532	7030010040	S.RES ERJ2GEJ-JPW	T	55.7/15.7
R1534	7030009140	S.RES ERJ2GEJ 272 X (2.7K)	B	37.2/24.6
R1535	7030005090	S.RES ERJ2GEJ 104 X (100K)	B	38.2/24.6
R1536	7030005060	S.RES ERJ2GEJ 333 X (33K)	T	32.4/10.3
R1537	7030005240	S.RES ERJ2GEJ 473 X (47K)	T	32.4/11.8
R1538	7030007350	S.RES ERJ2GEJ 393 X (39K)	B	123.5/35.6
R1539	7030005220	S.RES ERJ2GEJ 223 X (22K)	B	125.6/38.1
R2003	7030007250	S.RES ERJ2GEJ 220 X (22K)	B	16.7/6.8
R2004	7030005210	S.RES ERJ2GEJ 822 X (8.2K)	B	12.6/8.8
R2005	7030005210	S.RES ERJ2GEJ 822 X (8.2K)	B	15.8/6.8
R2013	7030005240	S.RES ERJ2GEJ 473 X (47K)	B	19.8/12.0
R2016	7030010040	S.RES ERJ2GEJ-JPW	B	24.0/5.8
R2019	7030010040	S.RES ERJ2GEJ-JPW	B	9.9/17.9
R2020	7030010040	S.RES ERJ2GEJ-JPW	B	14.4/11.1
R2021	7030004980	S.RES ERJ2GEJ 101 X (100)	B	23.6/12.1
R2022	7030004980	S.RES ERJ2GEJ 101 X (100)	B	27.9/24.7
R2024	7030005240	S.RES ERJ2GEJ 473 X (47K)	B	26.6/21.6
R2026	7030004970	S.RES ERJ2GEJ 470 X (47)	B	27.9/22.9
R2028	7030005240	S.RES ERJ2GEJ 473 X (47K)	B	12.1/19.3
R2030	7030005240	S.RES ERJ2GEJ 473 X (47K)	B	11.0/21.2
R2031	7030005240	S.RES ERJ2GEJ 473 X (47K)	B	10.7/29.4
R2032	7030005240	S.RES ERJ2GEJ 473 X (47K)	B	24.9/17.4
R2034	7030005240	S.RES ERJ2GEJ 473 X (47K)	B	28.8/10.5
R2035	7030005240	S.RES ERJ2GEJ 473 X (47K)	B	26.7/14.9
R2036	7030004980	S.RES ERJ2GEJ 101 X (100)	T	26.8/11.9
R2037	7030007290	S.RES ERJ2GEJ 222 X (2.2K)	T	28.1/10.7
R2038	7030004970	S.RES ERJ2GEJ 470 X (47)	B	28.8/12.1
R2039	7030005240	S.RES ERJ2GEJ 473 X (47K)	B	24.1/9.5
R2040	7030005240	S.RES ERJ2GEJ 473 X (47K)	B	24.5/12.1
R2043	7410001140	S.ARR EXB28V104JX	T	15.6/26.7
R2044	7410001140	S.ARR EXB28V104JX	B	20.8/26.3
R2045	7410001140	S.ARR EXB28V104JX	T	27.0/22.6
R2046	7410001140	S.ARR EXB28V104JX	T	19.3/26.7
R2047	7410001140	S.ARR EXB28V104JX	B	10.9/14.5
R2048	7030005090	S.RES ERJ2GEJ 104 X (100K)	T	25.7/14.6
R2049	7030005090	S.RES ERJ2GEJ 104 X (100K)	B	21.8/15.6
R2050	7410001140	S.ARR EXB28V104JX	B	22.6/18.2
R2051	7410001140	S.ARR EXB28V104JX	T	9.9/17.6
R2052	7030005090	S.RES ERJ2GEJ 104 X (100K)	T	16.8/11.6
R2053	7030005090	S.RES ERJ2GEJ 104 X (100K)	T	16.0/14.5
R2056	7030010040	S.RES ERJ2GEJ-JPW	T	10.6/20.0
R2057	7030005090	S.RES ERJ2GEJ 104 X (100K)	T	10.4/22.9
R2058	7410001140	S.ARR EXB28V104JX	B	17.0/18.6
R2059	7030005090	S.RES ERJ2GEJ 104 X (100K)	T	10.4/23.8
R2060	7030005090	S.RES ERJ2GEJ 104 X (100K)	T	25.7/15.6
R2061	7030005090	S.RES ERJ2GEJ 104 X (100K)	B	14.7/12.6
R2062	7030005090	S.RES ERJ2GEJ 104 X (100K)	B	17.7/14.4
R2063	7030005090	S.RES ERJ2GEJ 104 X (100K)	B	22.1/23.4

Eqv.= This component is equivalent to the REF No. component listed above, and may be substituted on parts orders and repairs.

[MAIN-D UNIT] (For [Low band] versions)

REF NO.	PARTS NO.	DESCRIPTION	M.	H/V LOCATION
R2064	7030005090	S.RES ERJ2GEJ 104 X (100K)	B	19.7/17.7
R2065	7030005030	S.RES ERJ2GEJ 152 X (1.5K)	B	13.8/6.8
R2076	7030010040	S.RES ERJ2GEJ-JPW	T	28.4/18.8
R2077	7030010040	S.RES ERJ2GEJ-JPW	T	27.7/16.4
R2086	7030004970	S.RES ERJ2GEJ 470 X (47)	T	17.3/7.3
R2087	7030004970	S.RES ERJ2GEJ 470 X (47)	T	18.9/7.0
R2088	7030004990	S.RES ERJ2GEJ 221 X (220)	T	19.9/7.0
R2089	7030004970	S.RES ERJ2GEJ 470 X (47)	T	21.9/7.0
R2090	7030010040	S.RES ERJ2GEJ-JPW	B	8.7/9.0
C1	4030011070	S.CER GRM31M2C2H5R0CY21L (GRM42-6 CH)	B	8.4/66.6
C2	4030011070	S.CER GRM31M2C2H5R0CY21L (GRM42-6 CH)	B	7.4/58.6
C3	4030009500	S.CER C1608 CH 1H 0R5B-T	B	25.6/51.9
C4	4030009500	S.CER C1608 CH 1H 0R5B-T	B	16.4/51.9
C5	4030009500	S.CER C1608 CH 1H 0R5B-T	B	8.2/54.5
C6	4030011090	S.CER GRM31M2C2H6R0DV01L (GRM42-6 CH)	B	7.4/56.3
C7	4030011070	S.CER GRM31M2C2H5R0CY21L (GRM42-6 CH)	B	13.1/60.7
C8	4030011070	S.CER GRM31M2C2H5R0CY21L (GRM42-6 CH)	B	19.5/60.7
C9	4030011080	S.CER GRM31M2C2H6R0DV01L (GRM42-6 CH)	T	30.6/53.1
C10	4030017730	S.CER C1005 JB 1H 471K-T	B	18.1/48.1
C11	4030017730	S.CER C1005 JB 1H 471K-T	B	10.0/49.2
C12	4030017730	S.CER C1005 JB 1H 471K-T	T	39.4/54.4
C13	4030017420	S.CER C1005 CH 1H 470J-T	B	49.5/51.4
C14	4030019420	S.CER GRM31A7U2J102JW31D	B	34.9/55.5
C15	4030017570	S.CER C1005 CH 1H 040B-T	T	23.7/50.4
C20	4030017400	S.CER C1005 CH 1H 220J-T	B	30.6/40.5
C21	4030017590	S.CER C1005 CH 1H 070C-T	B	26.7/38.1
C22	4030017360	S.CER C1005 CH 1H 030B-T	B	32.0/37.5
C25	4030017420	S.CER C1005 CH 1H 470J-T	B	25.8/38.1
C26	4030017390	S.CER C1005 CH 1H 180J-T	B	33.4/40.5
C27	4030016930	S.CER C1005 JB 1A 104K-T	B	31.5/38.8
C28	4030017460	S.CER C1005 JB 1H 102K-T	B	32.5/36.2
C29	4030017580	S.CER C1005 CH 1H 060C-T	B	37.1/37.4
C30	4030017630	S.CER C1005 CH 1H 120J-T	B	39.2/37.9
C31	4030016930	S.CER C1005 JB 1A 104K-T	B	51.5/37.4
C32	4030017460	S.CER C1005 JB 1H 102K-T	B	41.3/40.7
C33	4030017420	S.CER C1005 CH 1H 470J-T	B	38.6/40.7
C34	4030017460	S.CER C1005 JB 1H 102K-T	B	37.7/40.7
C36	4030017460	S.CER C1005 JB 1H 102K-T	B	51.5/41.2
C37	4030017730	S.CER C1005 JB 1H 471K-T	B	49.0/42.7
C38	4030017460	S.CER C1005 JB 1H 102K-T	B	39.2/35.9
C39	4030017620	S.CER C1005 CH 1H 100C-T	B	52.8/40.0
C40	4030017530	S.CER C1005 CH 1H 0R5B-T	B	54.1/39.2
C41	4030017400	S.CER C1005 CH 1H 220J-T	B	66.9/39.2
C42	4030017460	S.CER C1005 JB 1H 102K-T	T	54.0/37.8
C43	4030016930	S.CER C1005 JB 1A 104K-T	B	54.1/38.3
C44	4030017360	S.CER C1005 CH 1H 030B-T	B	59.9/40.5
C45	4030017630	S.CER C1005 CH 1H 120J-T	B	55.5/42.0
C48	4030017420	S.CER C1005 CH 1H 470J-T	B	72.2/40.6
C49	4030017380	S.CER C1005 CH 1H 050B-T	B	75.9/39.2
C50	4030017460	S.CER C1005 JB 1H 102K-T	B	73.1/40.6
C51	4030017460	S.CER C1005 JB 1H 102K-T	T	72.4/41.1
C52	4030017620	S.CER C1005 CH 1H 100C-T	B	70.4/41.2
C53	4030016930	S.CER C1005 JB 1E 103K-T	B	71.3/42.8
C54	4030017730	S.CER C1005 JB 1H 471K-T	B	70.4/42.8
C57	4030017460	S.CER C1005 JB 1H 102K-T	B	74.6/36.7
C58	4030017460	S.CER C1005 JB 1H 102K-T	T	67.2/26.1
C59	4030017460	S.CER C1005 JB 1H 102K-T	T	66.9/22.7
C60	4030016930	S.CER C1005 JB 1E 103K-T	T	65.3/26.6
C61	4030017430	S.CER C1005 CH 1H 101J-T	T	61.6/23.1
C62	4030017400	S.CER C1005 CH 1H 220J-T	B	57.1/24.3
C63	4030017420	S.CER C1005 CH 1H 470J-T	T	60.3/14.3
C64	4030016930	S.CER C1005 JB 1E 103K-T	B	56.2/26.8
C65	4030016930	S.CER C1005 JB 1E 103K-T	T	58.2/19.6
C66	4030017460	S.CER C1005 JB 1H 102K-T	T	54.7/19.9
C67	4030017460	S.CER C1005 JB 1H 102K-T	B	58.4/21.3
C68	4030017680	S.CER C1005 CH 1H 820J-T	T	52.2/23.8
C69	4030017710	S.CER C1005 CH 1H 181J-T	T	54.0/23.8
C70	4030017430	S.CER C1005 CH 1H 101J-T	T	54.0/25.6
C71	4030016930	S.CER C1005 JB 1A 104K-T	T	54.7/29.0
C72	4030017730	S.CER C1005 JB 1H 471K-T	[#57]	59.8/48.0
	4030017730	S.CER C1005 JB 1H 471K-T	[#59]	
	4030017730	S.CER C1005 JB 1H 471K-T	[#62]	
	4030017730	S.CER C1005 JB 1H 471K-T	[#71]	
C74	4			

[MAIN-D UNIT] (For [Low band] versions)

REF NO.	PARTS NO.	DESCRIPTION	M.	H/V LOCATION
C93	4030017620	S.CER C1005 CH 1H 100C-T	B	86.9/51.5
C96	4030017460	S.CER C1005 JB 1H 102K-T	B	87.8/56.3
C97	4030017730	S.CER C1005 JB 1H 471K-T	B	87.8/55.4
C98	4030017620	S.CER C1005 CH 1H 100C-T	B	83.5/48.7
C99	4030017730	S.CER C1005 JB 1H 471K-T	B	81.4/48.3
C100	4030017620	S.CER C1005 CH 1H 100C-T	B	91.2/34.9
C102	4030017570	S.CER C1005 CH 1H 040B-T	B	97.1/33.8
C103	4030017350	S.CER C1005 CH 1H 020B-T	B	98.5/32.2
C104	4030017460	S.CER C1005 JB 1H 102K-T	B	100.8/29.9
C105	4030017460	S.CER C1005 JB 1H 102K-T	B	97.6/28.9
C106	4030017420	S.CER C1005 CH 1H 470J-T	B	91.7/48.9
C107	4030017460	S.CER C1005 JB 1H 102K-T	T	80.2/51.7
C108	4030016790	S.CER C1005 JB 1E 103K-T	B	81.3/49.2
C109	4030017460	S.CER C1005 JB 1H 102K-T	B	95.8/35.3
C110	4030017730	S.CER C1005 JB 1H 471K-T	B	98.6/35.3
C112	4030016930	S.CER C1005 JB 1A 104K-T	T	100.8/37.1
C113	4030017540	S.CER C1005 CH 1H R75B-T	B	102.0/29.6
C114	4030017610	S.CER C1005 CH 1H 090C-T	B	98.3/26.1
C115	4030017400	S.CER C1005 CH 1H 220J-T	B	98.8/21.9
C116	4030017460	S.CER C1005 JB 1H 102K-T	B	107.5/30.0
C117	4030017730	S.CER C1005 JB 1H 471K-T	B	107.5/30.9
C118	4030017520	S.CER C1005 CH 1H 0R3B-T	B	102.8/32.0
C119	4030016790	S.CER C1005 JB 1E 103K-T	B	97.0/21.9
C120	4030017730	S.CER C1005 JB 1H 471K-T	B	97.9/21.9
C121	4030017590	S.CER C1005 CH 1H 070C-T	B	103.3/30.8
C122	4030017390	S.CER C1005 CH 1H 180J-T	B	107.5/31.8
C123	4030020040	S.CER C1005 CH 1H 200J-T	B	104.8/28.2
C124	4030017400	S.CER C1005 CH 1H 220J-T	B	105.0/20.8
C125	4030017420	S.CER C1005 CH 1H 470J-T	B	101.7/27.5
C126	4030017610	S.CER C1005 CH 1H 090C-T	B	95.6/23.7
C127	4030017410	S.CER C1005 CH 1H 240J-T	B	96.1/21.9
C128	4030017360	S.CER C1005 CH 1H 030B-T	B	99.2/27.3
C129	4030017530	S.CER C1005 CH 1H 0R5B-T	B	103.5/27.5
C131	4030017530	S.CER C1005 CH 1H 0R5B-T	B	106.4/27.2
C132	4030017460	S.CER C1005 JB 1H 102K-T	T	94.3/12.6
C133	4030017620	S.CER C1005 CH 1H 100C-T	B	105.4/22.7
C134	4030017620	S.CER C1005 CH 1H 100C-T	B	93.7/22.8
C135	4030016790	S.CER C1005 JB 1E 103K-T	T	78.3/21.0
C139	4030016930	S.CER C1005 JB 1A 104K-T	B	107.5/33.6
C140	4030017430	S.CER C1005 CH 1H 101J-T	B	81.2/18.9
C141	4030017460	S.CER C1005 JB 1H 102K-T	T	75.7/21.5
C142	4030021140	S.CER GRM31C2C1H683JA01L	T	82.6/23.0
C143	4030017460	S.CER C1005 JB 1H 102K-T	T	78.9/22.2
C144	4030017420	S.CER C1005 CH 1H 470J-T	T	92.5/16.1
C147	4550003250	S.TAN TEESVA 1V 474M8R	T	80.5/22.9
Eqv.	4550007590	S.TAN F931V474MAABMA		
C148	4030019560	S.CER GRM21BB31C106KE15L	T	109.7/30.5
C151	4030016930	S.CER C1005 JB 1A 104K-T	B	75.3/18.1
C152	4030017420	S.CER C1005 CH 1H 470J-T	B	77.8/18.1
C153	4030017420	S.CER C1005 CH 1H 470J-T	B	78.1/16.2
C154	4030017420	S.CER C1005 CH 1H 470J-T	B	76.4/16.2
C155	4030017460	S.CER C1005 JB 1H 102K-T	B	81.7/16.7
C156	4030016790	S.CER C1005 JB 1E 103K-T	B	81.2/17.9
C157	4030017620	S.CER C1005 CH 1H 100C-T	B	72.4/24.4
C160	4030016930	S.CER C1005 JB 1A 104K-T	B	74.3/21.3
C162	4030016790	S.CER C1005 JB 1E 103K-T	B	72.4/17.7
C165	4030017460	S.CER C1005 JB 1H 102K-T	B	74.1/23.5
C192	4030017360	S.CER C1005 CH 1H 030B-T	B	34.3/40.5
C193	4030017340	S.CER C1005 CH 1H 010B-T	B	51.5/38.3
C277	4030016930	S.CER C1005 JB 1A 104K-T	B	33.9/30.7
C281	4030017770	S.CER C1005 JB 1H 332K-T	T	92.0/13.5
C282	4030016930	S.CER C1005 JB 1A 104K-T	T	44.2/28.0
C283	4030016930	S.CER C1005 JB 1A 104K-T	T	42.5/25.2
C284	4030016930	S.CER C1005 JB 1A 104K-T	T	44.2/28.9
C285	4030017580	S.CER C1005 CH 1H 060C-T	B	94.0/29.9
C286	4030017600	S.CER C1005 CH 1H 080C-T	B	35.1/28.5
C287	4030018100	S.CER C1005 JB 1H 681K-T	T	95.9/11.7
C298	4030017630	S.CER C1005 CH 1H 120J-T	T	86.3/29.4
C299	4030017570	S.CER C1005 CH 1H 040B-T	T	83.9/29.4
C300	4030017350	S.CER C1005 CH 1H 020B-T	T	85.1/30.8
C301	4030017730	S.CER C1005 JB 1H 471K-T	B	92.8/31.3
C302	4030017420	S.CER C1005 CH 1H 470J-T	B	80.1/39.2
C303	4030017730	S.CER C1005 JB 1H 471K-T	B	80.1/36.3
C305	4030017500	S.CER C1005 CH 1H 560J-T	B	64.8/24.2
C306	4030017580	S.CER C1005 CH 1H 060C-T	B	64.3/25.4
C307	4030017500	S.CER C1005 CH 1H 560J-T	B	61.3/22.7
C308	4030017360	S.CER C1005 CH 1H 030B-T	B	60.1/23.2
C309	4030016790	S.CER C1005 JB 1E 103K-T	B	67.4/21.8
C312	4030016930	S.CER C1005 JB 1A 104K-T	B	67.4/20.9
C314	4030016790	S.CER C1005 JB 1E 103K-T	T	110.5/33.8
C323	4030017620	S.CER C1005 CH 1H 100C-T	B	72.3/26.2
C328	4030017560	S.CER C1005 CH 1H 2R5B-T	B	85.4/55.8
C332	4030017530	S.CER C1005 CH 1H 0R5B-T	B	84.9/50.0
C333	4030017420	S.CER C1005 CH 1H 470J-T	B	40.4/40.7
C334	4030017590	S.CER C1005 CH 1H 070C-T	B	94.9/68.3
C335	4030017630	S.CER C1005 CH 1H 120J-T	B	93.8/68.3
C336	4030017710	S.CER C1005 CH 1H 181J-T	B	62.0/68.7
C337	4030017460	S.CER C1005 JB 1H 102K-T	T	82.7/29.2
C340	4030017710	S.CER C1005 CH 1H 181J-T	B	107.7/28.7
C342	4550002980	S.TAN TEESVA 1C 225M8R	T	78.4/66.1
Eqv.	4550007390	S.TAN F931C225MAABMA		
C343	4030017460	S.CER C1005 JB 1H 102K-T	B	51.5/39.2
C344	4030017460	S.CER C1005 JB 1H 102K-T	B	54.2/68.0
C345	4030017730	S.CER C1005 JB 1H 471K-T	B	54.2/67.1
C346	4030017420	S.CER C1005 CH 1H 470J-T	B	66.0/68.7
C347	4030017460	S.CER C1005 JB 1H 102K-T	T	52.2/22.9
C348	4030017460	S.CER C1005 JB 1H 102K-T	T	59.3/20.5
C350	4030017920	S.CER C1005 JB 1A 683K-T	T	95.9/14.4
C357	4030016930	S.CER C1005 JB 1A 104K-T	T	105.1/36.1
C358	4030017340	S.CER C1005 CH 1H 010B-T	B	91.2/35.8
C366	4030017460	S.CER C1005 JB 1H 102K-T	B	97.0/64.4
C367	4030017730	S.CER C1005 JB 1H 471K-T	B	97.0/65.8
C368	4030017420	S.CER C1005 CH 1H 470J-T	B	97.0/67.3
C372	4030017730	S.CER C1005 JB 1H 471K-T	T	60.3/67.7
C376	4030017730	S.CER C1005 JB 1H 471K-T	B	88.7/49.5

Eqv.= This component is equivalent to the REF No. component listed above, and may be substituted on parts orders and repairs.

[MAIN-D UNIT] (For [Low band] versions)

REF NO.	PARTS NO.	DESCRIPTION	M.	H/V LOCATION
C377	4030017460	S.CER C1005 JB 1H 102K-T	T	57.8/61.6
C383	4030016930	S.CER C1005 JB 1A 104K-T	T	36.4/36.2
C384	4030016930	S.CER C1005 JB 1A 104K-T	T	59.3/29.0
C385	4030016930	S.CER C1005 JB 1A 104K-T	B	54.9/28.9
C388	4030017730	S.CER C1005 JB 1H 471K-T	B	68.2/36.7
C390	4030017460	S.CER C1005 JB 1H 102K-T	B	75.0/40.6
C391	4030017420	S.CER C1005 CH 1H 470J-T	B	75.9/40.7
C392	4030017530	S.CER C1005 CH 1H 0R5B-T	B	60.3/39.2
C393	4030017550	S.CER C1005 CH 1H 1R5B-T	B	66.3/40.5
C394	4030016930	S.CER C1005 JB 1A 104K-T	B	50.9/28.8
C395	4030016930	S.CER C1005 JB 1A 104K-T	B	45.6/29.0
C396	4030016930	S.CER C1005 JB 1A 104K-T	T	55.8/29.0
C397	4030016790	S.CER C1005 JB 1E 103K-T	B	55.9/13.2
C398	4030016790	S.CER C1005 JB 1E 103K-T	B	48.6/27.3
C399	4030016790	S.CER C1005 JB 1E 103K-T	B	48.3/28.5
C400	4030017710	S.CER C1005 CH 1H 181J-T	T	81.2/37.6
C401	4030017570	S.CER C1005 CH 1H 040B-T	B	78.6/40.6
C402	4030011060	S.CER GRM31M2C2H4R0CY21L (GRM42-6 CH)	B	38.0/68.7
C403	4030011060	S.CER GRM31M2C2H4R0CY21L (GRM42-6 CH)	B	34.9/65.2
C404	4030011100	S.CER GRM31M2C2H8R0DV01L (GRM42-6 CH)	B	15.5/60.7
C408	4030017730	S.CER C1005 JB 1H 471K-T	B	23.9/48.1
C409	4030017460	S.CER C1005 JB 1H 102K-T	B	39.3/51.1
C411	4030017460	S.CER C1005 JB 1H 102K-T	T	42.2/55.4
			[#57]	
			[#59]	
			[#62]	
			[#71]	
C413	4030018860	S.CER C1005 JB 0J 105K-T	B	91.5/25.3
C416	4030017420	S.CER C1005 CH 1H 470J-T	B	93.4/25.3
C418	4030018890	S.CER C1005 JB 0J 224K-T	T	102.8/17.3
C420	4030011090	S.CER GRM31M2C2H7R0DV01L (GRM42-6 CH)	B	21.7/60.7
C421	4030011060	S.CER GRM31M2C2H4R0CY21L (GRM42-6 CH)	B	28.2/60.7
C423	4030017570	S.CER C1005 CH 1H 040B-T	B	77.7/40.6
C429	4030017630	S.CER C1005 CH 1H 120J-T	B	61.9/42.0
C447	4030017730	S.CER C1005 JB 1H 471K-T	B	83.3/52.0
C448	4030017670	S.CER C1005 CH 1H 390J-T	B	87.8/49.5
C453	4030017420	S.CER C1005 CH 1H 470J-T	B	101.3/35.3
C454	4030017460	S.CER C1005 JB 1H 102K-T	B	100.4/35.3
C457	4030017420	S.CER C1005 CH 1H 470J-T	B	54.0/37.4
C458	4030017420	S.CER C1005 CH 1H 470J-T	T	63.8/50.8
C459	4030017420	S.CER C1005 CH 1H 470J-T	T	86.1/48.4
C460	4030017420	S.CER C1005 CH 1H 470J-T	T	64.9/49.8
C463	4030018820	S.CER C1005 JB 1H 561K-T	T	54.0/26.5
C466	4030017420	S.CER C1005 CH 1H 470J-T	T	62.7/49.8
C467	4030017420	S.CER C1005 CH 1H 470J-T	T	88.4/10.4
C471	4030017420	S.CER C1005 CH 1H 470J-T	B	103.7/19.2
C624	4030017460	S.CER C1005 JB 1H 102K-T	B	81.2/26.7
C628	4030017590	S.CER C1005 CH 1H 070C-T	T	63.3/36.2
C629	4030017530	S.CER C1005 CH 1H 0R5B-T	T	66.8/29.7
C630	4030016790	S.CER C1005 JB 1E 103K-T	T	66.8/28.8
C631	4030016790	S.CER C1005 JB 1E 103K-T	T	68.6/41.6
C632	4030016790	S.CER C1005 JB 1E 103K-T	T	76.5/41.6
C633	4030016930	S.CER C1005 JB 1A 104K-T	T	81.3/43.1
C634	4030016930	S.CER C1005 JB 1A 104K-T	T	80.0/41.2
C635	4030016790	S.CER C1005 JB 1E 103K-T	T	71.5/29.7
C637	4030017600	S.CER C1005 CH 1H 080C-T	T	72.3/36.2
C638	4030017460	S.CER C1005 JB 1H 102K-T	T	83.5/42.2
C639	4030016930	S.CER C1005 JB 1A 104K-T	T	46.8/25.7
C640	4030017040	S.CER C1005 JB 1A 333K-T	B	37.5/26.7
C641	4030018890	S.CER C1005 JB 0J 224K-T	B	76.3/27.1
C642	4030018890	S.CER C1005 JB 0J 224K-T	B	77.5/27.0
C643	4030017430	S.CER C1005 CH 1H 101J-T	B	77.5/27.0
C644	4030019560	S.CER GRM21BB31C106KE15L	B	81.7/20.4
C645	4030016930	S.CER C1005 JB 1A 104K-T	B	30.0/15.7
C646	4030017460	S.CER C1005 JB 1H 102K-T	T	84.7/10.0
C647	4030016790	S.CER C1005 JB 1E 103K-T	B	59.1/27.7
C1003	4030017460	S.CER C1005 JB 1H 102K-T	T	133.3/63.5
C1005	4030018980	S.CER C1608 JB 1H 104K-T	B	100.1/11.8
C1007	4030017460	S.CER C1005 JB 1H 102K-T	T	100.1/12.1
C1008	4510009680	S.ELE EEEFK1E471P	B	110.2/52.6
C1010	4030017460	S.CER C1005 JB 1H 102K-T	B	

[MAIN-D UNIT] (For [Low band] versions)

REF NO.	PARTS NO.	DESCRIPTION	M.	H/V LOCATION
C1051	4030017460	S.CER C1005 JB 1H 102K-T	B	122.1/48.2
C1052	4030016930	S.CER C1005 JB 1A 104K-T	T	127.8/40.1
C1053	4030019560	S.CER GRM21BB31C106KE15L	T	127.8/44.5
C1056	4030018860	S.CER C1005 JB 0J 105K-T	T	111.2/11.7
C1057	4030016930	S.CER C1005 JB 1A 104K-T	B	118.7/17.1
C1058	4030019560	S.CER GRM21BB31C106KE15L	T	105.5/44.4
C1059	4030017460	S.CER C1005 JB 1H 102K-T	T	107.7/46.3
C1060	4030017460	S.CER C1005 JB 1H 102K-T	B	126.4/39.8
C1061	4030017460	S.CER C1005 JB 1H 102K-T	T	107.7/37.4
C1062	4030017460	S.CER C1005 JB 1H 102K-T	B	120.7/22.9
C1063	4030019560	S.CER GRM21BB31C106KE15L	B	126.9/22.2
C1064	4030019560	S.CER GRM21BB31C106KE15L	B	121.6/36.0
C1065	4030017460	S.CER C1005 JB 1H 102K-T	B	120.2/35.6
C1066	4030018860	S.CER C1005 JB 0J 105K-T	B	124.9/39.7
C1070	4030017440	S.CER C1005 CH 1H 221J-T	B	120.4/16.2
C1071	4030016930	S.CER C1005 JB 1A 104K-T	B	120.4/10.8
C1074	4030017460	S.CER C1005 JB 1H 102K-T	B	73.9/10.4
C1075	4030017460	S.CER C1005 JB 1H 102K-T	B	70.7/14.4
C1076	4030017460	S.CER C1005 JB 1H 102K-T	B	69.7/14.4
C1077	4030017460	S.CER C1005 JB 1H 102K-T	B	68.8/14.4
C1081	4030016930	S.CER C1005 JB 1A 104K-T	B	117.2/15.2
C1082	4030016930	S.CER C1005 JB 1A 104K-T	B	114.8/14.6
C1085	4030017460	S.CER C1005 JB 1H 102K-T	T	76.3/14.6
C1092	4030016930	S.CER C1005 JB 1A 104K-T	B	75.8/14.4
C1098	4030018860	S.CER C1005 JB 0J 105K-T	T	53.4/16.3
C1100	4030017460	S.CER C1005 JB 1H 102K-T	B	75.8/9.1
C1101	4030017420	S.CER C1005 CH 1H 470J-T	T	78.2/8.0
C1102	4030017420	S.CER C1005 CH 1H 470J-T	B	71.6/6.6
C1119	4030017420	S.CER C1005 CH 1H 470J-T	B	65.2/6.9
C1133	4030016790	S.CER C1005 JB 1E 103K-T	T	78.2/5.7
C1135	4030017460	S.CER C1005 JB 1H 102K-T	T	73.9/16.8
C1136	4030016930	S.CER C1005 JB 1A 104K-T	T	71.6/15.5
C1142	4030016930	S.CER C1005 JB 1A 104K-T	B	117.6/11.8
C1143	4030018980	S.CER C1608 JB 1H 104K-T	B	93.8/9.4
C1500	4030016930	S.CER C1005 JB 1A 104K-T	T	35.6/14.3
C1501	4030018860	S.CER C1005 JB 0J 105K-T	T	34.0/16.3
C1502	4030019990	S.CER C1005 JB 1C 104K-T	T	35.2/15.7
C1503	4030018090	S.CER C1005 JB 1E 822K-T	T	32.7/16.8
C1504	4030017430	S.CER C1005 CH 1H 101J-T	T	32.3/18.0
C1505	4030018860	S.CER C1005 JB 0J 105K-T	B	30.6/17.2
C1506	4030020120	S.CER C1005 JB 0J 225M-T	T	32.4/19.3
C1507	4030018860	S.CER C1005 JB 0J 105K-T	B	31.9/18.0
C1511	4030016790	S.CER C1005 JB 1E 103K-T	B	35.0/23.3
C1512	4030018860	S.CER C1005 JB 0J 105K-T	B	36.3/24.3
C1515	4030018860	S.CER C1005 JB 0J 105K-T	T	36.2/19.6
C1516	4030017710	S.CER C1005 CH 1H 181J-T	T	37.6/20.7
C1517	4030018860	S.CER C1005 JB 0J 105K-T	B	37.9/23.0
C1518	4030016930	S.CER C1005 JB 1A 104K-T	B	38.8/23.0
C1519	4030020000	S.CER C1005 JB 1A 105K-T	B	42.7/22.2
C1520	4030020000	S.CER C1005 JB 1A 105K-T	B	41.8/22.2
C1521	4030020000	S.CER C1005 JB 1A 105K-T	B	40.9/22.1
C1522	4030020000	S.CER C1005 JB 1A 105K-T	B	42.8/20.3
C1523	4030017900	S.CER C1005 JB 1E 123K-T	T	42.6/20.4
C1524	4030016930	S.CER C1005 JB 1A 104K-T	B	44.0/20.5
C1525	4030017460	S.CER C1005 JB 1H 102K-T	B	44.9/20.5
C1526	4030017460	S.CER C1005 JB 1H 102K-T	T	40.2/16.1
C1527	4030016930	S.CER C1005 JB 1A 104K-T	T	41.1/16.1
C1528	4030016930	S.CER C1005 JB 1A 104K-T	T	37.6/13.0
C1529	4030017460	S.CER C1005 JB 1H 102K-T	T	39.1/12.2
C1530	4030017920	S.CER C1005 JB 1A 683K-T	B	33.1/13.1
C1532	4030020020	S.CER C1005 CH 1H 391J-T	T	43.8/18.1
C2001	4050000240	S.FEE NFM18PC104R1C3D	T	39.4/8.8
C2002	4030016930	S.CER C1005 JB 1A 104K-T	B	35.1/5.3
C2004	4550007730	S.TAN TEESVJ 0J 106M8R	B	35.5/7.0
	Eqv.	4550008380 S.TAN TMCJ0J106MTRF		
C2007	4030018910	S.CER C1608 JB 0J 475K-T	B	18.4/10.4
C2008	4030016930	S.CER C1005 JB 1A 104K-T	B	16.1/8.9
C2009	4050000240	S.FEE NFM18PC104R1C3D	B	28.0/5.9
C2010	4050000240	S.FEE NFM18PC104R1C3D	B	12.3/5.5
C2011	4030019460	S.CER C1608 JB 0J 106M-T	T	33.0/6.9
C2012	4030016930	S.CER C1005 JB 1A 104K-T	B	26.4/5.8
C2013	4550007730	S.TAN TEESVJ 0J 106M8R	B	25.0/6.2
	Eqv.	4550008380 S.TAN TMCJ0J106MTRF		
C2014	4030016930	S.CER C1005 JB 1A 104K-T	T	31.7/6.6
C2015	4030016930	S.CER C1005 JB 1A 104K-T	B	10.1/6.4
C2016	4550007720	S.TAN TEESVJ 0G 476M8R	T	26.7/7.1
	Eqv.	4550008410 TAN 251M4001 476MR12S		
C2017	4550007730	S.TAN TEESVJ 0J 106M8R	B	17.2/9.2
	Eqv.	4550008380 S.TAN TMCJ0J106MTRF		
C2019	4030016790	S.CER C1005 JB 1E 103K-T	B	14.8/19.3
C2021	4030018910	S.CER C1608 JB 0J 475K-T	B	16.0/21.6
C2022	4030018910	S.CER C1608 JB 0J 475K-T	B	13.5/14.5
C2023	4030016790	S.CER C1005 JB 1E 103K-T	B	23.1/14.3
C2024	4030018860	S.CER C1005 JB 0J 105K-T	B	21.2/14.1
C2033	4030018860	S.CER C1005 JB 0J 105K-T	B	15.1/17.7
C2036	4030018860	S.CER C1005 JB 0J 105K-T	B	21.1/20.9
C2038	4030016790	S.CER C1005 JB 1E 103K-T	B	16.4/25.3
C2040	4030016790	S.CER C1005 JB 1E 103K-T	T	26.4/18.1
C2041	4030018910	S.CER C1608 JB 0J 475K-T	T	11.1/14.5
C2042	4030016930	S.CER C1005 JB 1A 104K-T	T	10.1/14.8
C2044	4030016790	S.CER C1005 JB 1E 103K-T	T	26.4/19.9
C2045	4030016930	S.CER C1005 JB 1A 104K-T	B	26.6/23.4
C2046	4030016930	S.CER C1005 JB 1A 104K-T	B	26.6/24.3
C2047	4030016930	S.CER C1005 JB 1A 104K-T	B	26.6/20.7
C2048	4030016930	S.CER C1005 JB 1A 104K-T	B	26.6/22.5
C2049	4030017420	S.CER C1005 CH 1H 470J-T	B	25.7/9.5
C2050	4030017620	S.CER C1005 CH 1H 100C-T	B	26.7/15.8
C2051	4030016930	S.CER C1005 JB 1A 104K-T	B	13.6/29.4
C2052	4030016930	S.CER C1005 JB 1A 104K-T	B	25.5/15.3
C2053	4030017460	S.CER C1005 JB 1H 102K-T	B	27.4/10.4
C2054	4030016930	S.CER C1005 JB 1A 104K-T	T	25.5/12.4
C2055	4030017400	S.CER C1005 CH 1H 220J-T	B	11.0/20.3
C2056	4030017380	S.CER C1005 CH 1H 050B-T	T	27.2/10.7
C2057	4030016930	S.CER C1005 JB 1A 104K-T	B	24.1/10.4
C2058	4030016790	S.CER C1005 JB 1E 103K-T	B	28.8/13.7

Eqv.= This component is equivalent to the REF No. component listed above, and may be substituted on parts orders and repairs.

[MAIN-D UNIT] (For [High band] versions)

REF NO.	PARTS NO.	DESCRIPTION	M.	H/V LOCATION
C2062	4030018860	S.CER C1005 JB 0J 105K-T	T	9.4/20.1
C2063	4030017420	S.CER C1005 CH 1H 470J-T	T	2.1/14.7
C2064	4030017420	S.CER C1005 CH 1H 470J-T	T	2.5/13.5
C2065	4030017420	S.CER C1005 CH 1H 470J-T	T	3.8/13.0
C2066	4030017420	S.CER C1005 CH 1H 470J-T	T	6.5/16.5
C2067	4030017420	S.CER C1005 CH 1H 470J-T	T	7.5/24.0
C2069	4030017420	S.CER C1005 CH 1H 470J-T	T	27.5/17.2
C2070	4030016930	S.CER C1005 JB 1A 104K-T	B	21.0/12.5
C2071	4030016930	S.CER C1005 JB 1A 104K-T	B	21.7/19.7
C2072	4030016930	S.CER C1005 JB 1A 104K-T	B	17.2/23.8
C2073	4030016930	S.CER C1005 JB 1A 104K-T	B	20.2/16.7
C2076	4030016930	S.CER C1005 JB 1A 104K-T	T	7.7/27.1
C2077	4030019610	S.CER GRM155B31A105KE15D	B	41.2/6.1
C2078	4030017460	S.CER C1005 JB 1H 102K-T	B	39.8/9.0
C2079	4030017460	S.CER C1005 JB 1H 102K-T	B	38.2/9.0
C2080	4030016790	S.CER C1005 JB 1E 103K-T	B	36.7/5.3
C2081	4550007730	S.TAN TEESVJ 0J 106M8R	B	36.7/7.0
	Eqv.	4550008380 S.TAN TMCJ0J106MTRF		
C2082	4550007720	S.TAN TEESVJ 0G 476M8R	[#06] T	28.5/7.0
	Eqv.	4550008410 TAN 251M4001 476MR12S	[#06] [21]	
C2082	4550007720	S.TAN TEESVJ 0G 476M8R	[#21] T	28.5/7.0
	Eqv.	4550008410 TAN 251M4001 476MR12S	[#21] [06]	
C2083	4550007720	S.TAN TEESVJ 0G 476M8R	[#06] T	30.3/6.7
	Eqv.	4550008410 TAN 251M4001 476MR12S	[#06] [21]	
C2083	4550007720	S.TAN TEESVJ 0G 476M8R	[#21] T	30.3/6.7
	Eqv.	4550008410 TAN 251M4001 476MR12S	[#21] [06]	
C2084	4030017420	S.CER C1005 CH 1H 470J-T	T	35.0/12.4
C2085	4030017420	S.CER C1005 CH 1H 470J-T	T	34.1/11.6
C2086	4030017420	S.CER C1005 CH 1H 470J-T	T	22.0/5.4
C2087	4030017420	S.CER C1005 CH 1H 470J-T	T	17.3/5.7
C2088	4030017420	S.CER C1005 CH 1H 470J-T	T	17.3/8.9
C2089	4030017420	S.CER C1005 CH 1H 470J-T	T	18.9/9.5
C2090	4030017420	S.CER C1005 CH 1H 470J-T	T	21.2/8.6
C2091	4030017420	S.CER C1005 CH 1H 470J-T	T	36.5/12.1
C2092	4030017460	S.CER C1005 JB 1H 102K-T	T	30.0/23.0
J1001	6510014961	S.CON B2B-ZR-SM4-TF(LF)(SN)	T	130.5/27.3
J1002	6450000140	CON HSJ0807-01-010	T	120.0/17.2
J1003	6510022891	S.CON B13B-ZR-SM4-TF(LF)(SN)	T	67.5/10.6
J1004	6510022960	S.CON 04-6294-040-000-800	T	
S1001	2260003180	S.SWI MINISMDC050F-2 CN <UDX>	T	114.1/33.8
W1	7030012290	JUM RDS2T0R0		
W2	8900011863	CAB OPC-1195C <TJM>		
EP1	6910018460	S.BEA MMZ1005Y102C-T	B	107.5/32.7
EP4	6910010280	BEA HF70BB9.5X10.4X4.9		
EP5	6910010280	BEA HF70BB9.5X10.4X4.9		
EP7	6910018460	S.BEA MMZ1005Y102C-T	B	74.2/19.4
EP8	6910018460	S.BEA MMZ1005Y102C-T	B	80.8/16.7
EP13	6910018460	S.BEA MMZ1005Y102C-T	B	100.1/25.3
EP14	6910011560	BEA HF70BB4.5X5X1.6		
EP15	6910011560	BEA HF70BB4.5X5X1.6		
EP1003	6910016330	S.BEA MMZ1005S 601CT-S	B	42.8/19.2
EP1004	6910016330	S.BEA MMZ1005S 601CT-S	B	42.7/15.8
EP1005	6910016330	S.BEA MMZ1005S 601CT-S	T	43.1/15.8
EP1006	6910018460	S.BEA MMZ1005Y102C-T	T	39.6/13.4
EP2001	6910016330	S.BEA MMZ1005S 601CT-S	B	22.8/5.3
EP2005	6910016330	S.BEA MMZ1005S 601CT-S	B	24.6/23.8
EP2007	6910016330	S.BEA MMZ1005S 601CT-S	T	26.1/20.8
EP2008	6910015970	S.BEA MMZ1608B 301CT-AS	B	36.1/8.9
EP2009	6910018460	S.BEA MMZ1005Y102C-T	T	30.7/10.8
EP2010	6910018460	S.BEA MMZ1005Y102C-T	T	24.9/5.7

M.=Mounted side (T: Mounted on the Top side, B: Mounted on the Bottom side) S.=Surface mount

[MAIN-E UNIT] (For [High band] versions)

Table with 5 columns: REF NO., PARTS NO., DESCRIPTION, M., H/V LOCATION. Contains a long list of components such as IC2, IC3, IC4, etc., up to Q2001, including their part numbers and descriptions.

Eqv.= This component is equivalent to the REF No. component listed above, and may be substituted on parts orders and repairs.

[MAIN-E UNIT] (For [High band] versions)

Table with 5 columns: REF NO., PARTS NO., DESCRIPTION, M., H/V LOCATION. Contains a long list of components such as D1007, D1008, D2002, etc., up to R46, including their part numbers and descriptions.

M.=Mounted side (T: Mounted on the Top side, B: Mounted on the Bottom side) S.=Surface mount

[MAIN-E UNIT] (For [High band] versions)

REF NO.	PARTS NO.	DESCRIPTION	M.	H/V LOCATION
R48	7030008300	S.RES ERJ2GEJ 184 X (180K)	T	56.8/53.2
R49	7520000241	S.POS PRF18BC471QB5RB	T	47.3/53.2
R50	7030005050	S.RES ERJ2GEJ 103 X (10K)	B	80.1/37.9
R51	7030005080	S.RES ERJ2GEJ 823 X (82K)	T	61.8/49.8
R52	7030005070	S.RES ERJ2GEJ 683 X (68K)	T	58.7/52.1
R53	7030004990	S.RES ERJ2GEJ 221 X (22K)	T	57.8/53.2
R54	7030005220	S.RES ERJ2GEJ 223 X (22K)	B	58.8/55.7
R56	7030005110	S.RES ERJ2GEJ 224 X (220K)	T	63.3/55.0
R57	7030005050	S.RES ERJ2GEJ 103 X (10K)	B	58.8/54.8
R58	7030005570	S.RES ERJ2GEJ 820 X (82K)	T	64.2/55.0
R59	7030007350	S.RES ERJ2GEJ 393 X (39K)	T	59.7/52.1
R61	7030004970	S.RES ERJ2GEJ 470 X (47K)	B	90.5/49.5
R62	7030008290	S.RES ERJ2GEJ 183 X (18K)	B	89.6/49.5
R66	7030005090	S.RES ERJ2GEJ 104 X (100K)	B	84.9/49.1
R67	7030004980	S.RES ERJ2GEJ 101 X (10K)	B	83.0/47.3
R68	7030005050	S.RES ERJ2GEJ 103 X (10K)	B	82.6/48.7
R69	7030005040	S.RES ERJ2GEJ 472 X (4.7K)	B	84.0/38.0
R70	7030004990	S.RES ERJ2GEJ 221 X (22K)	B	92.8/35.8
R71	7030007260	S.RES ERJ2GEJ 330 X (33K)	B	95.3/33.8
R72	7030004980	S.RES ERJ2GEJ 101 X (10K)	B	86.5/49.1
R73	7030004980	S.RES ERJ2GEJ 101 X (10K)	B	99.5/35.3
R74	7030005080	S.RES ERJ2GEJ 823 X (82K)	B	101.3/33.7
R75	7030005720	S.RES ERJ2GEJ 563 X (56K)	B	97.6/32.2
R76	7030005030	S.RES ERJ2GEJ 152 X (1.5K)	B	96.7/32.2
R77	7030005120	S.RES ERJ2GEJ 102 X (1K)	T	106.6/36.1
R78	7030009270	S.RES ERJ2GEJ 821 X (82K)	T	102.5/32.5
R79	7030006020	S.RES RR0510P-682-D (6.8K)	B	96.5/23.7
R80	7030005120	S.RES ERJ2GEJ 102 X (1K)	T	100.0/32.5
R83	7030006020	S.RES RR0510P-682-D (6.8K)	B	106.4/29.1
R84	7030006020	S.RES RR0510P-682-D (6.8K)	B	106.4/28.2
R85	7030006020	S.RES RR0510P-682-D (6.8K)	B	95.6/25.3
R86	7030005110	S.RES ERJ2GEJ 224 X (220K)	B	102.6/24.4
R87	7030005530	S.RES ERJ2GEJ 100 X (10K)	B	102.6/27.5
R89	7030005050	S.RES ERJ2GEJ 103 X (10K)	T	79.0/25.0
R90	7030005170	S.RES ERJ2GEJ 474 X (470K)	T	95.9/15.3
R92	7030005100	S.RES ERJ2GEJ 154 X (150K)	T	94.3/14.4
R93	7030005600	S.RES ERJ2GEJ 273 X (27K)	B	81.3/25.8
R95	7030005710	S.RES ERJ2GEJ 121 X (12K)	B	83.8/24.5
R96	7030008400	S.RES ERJ2GEJ 182 X (1.8K)	B	83.8/23.5
R97	7030010040	S.RES ERJ2GEJ-JPW	B	82.2/24.5
R98	7030007290	S.RES ERJ2GEJ 222 X (2.2K)	T	109.5/33.8
R100	7030005240	S.RES ERJ2GEJ 473 X (47K)	T	76.1/20.3
R101	7030004980	S.RES ERJ2GEJ 101 X (10K)	T	77.9/22.2
R123	7030005530	S.RES ERJ2GEJ 100 X (10K)	T	68.2/40.4
R125	7030008370	S.RES ERJ2GEJ 561 X (56K)	T	65.6/29.2
R171	7030004980	S.RES ERJ2GEJ 101 X (10K)	T	45.5/28.6
R172	7030008300	S.RES ERJ2GEJ 184 X (180K)	T	44.2/27.1
R173	7030005120	S.RES ERJ2GEJ 102 X (1K)	T	42.9/26.4
R174	7030005290	S.RES ERJ2GEJ 682 X (6.8K)	T	42.0/28.8
R175	7030009290	S.RES ERJ2GEJ 562 X (5.6K)	T	41.6/27.6
R176	7030005030	S.RES ERJ2GEJ 152 X (1.5K)	T	42.0/26.4
R178	7030004970	S.RES ERJ2GEJ 470 X (47K)	B	38.4/26.7
R211	7030004970	S.RES ERJ2GEJ 470 X (47K)	T	82.7/28.3
R212	7030010040	S.RES ERJ2GEJ-JPW	T	82.6/60.4
R234	7030005070	S.RES ERJ2GEJ 683 X (68K)	B	92.8/34.9
R235	7030004980	S.RES ERJ2GEJ 101 X (10K)	B	81.0/37.9
R236	7030007570	S.RES ERJ2GEJ 122 X (1.2K)	B	67.4/22.7
R237	7030007060	S.RES ERJ2GEJ 684X (680K)	B	67.4/23.6
R289	7030005060	S.RES ERJ2GEJ 333 X (33K)	T	95.9/12.6
R290	7030007280	S.RES ERJ2GEJ 331 X (33K)	T	63.2/23.1
R291	7030005090	S.RES ERJ2GEJ 104 X (100K)	T	94.3/13.5
R293	7030006610	S.RES ERJ2GEJ 394 X (390K)	T	88.4/12.0
R295	7030006610	S.RES ERJ2GEJ 394 X (390K)	T	101.0/17.3
R299	7030008300	S.RES ERJ2GEJ 184 X (180K)	B	74.6/38.5
R300	7030005720	S.RES ERJ2GEJ 563 X (56K)	B	76.8/40.6
R301	7030005100	S.RES ERJ2GEJ 154 X (150K)	B	67.5/40.5
R302	7030005720	S.RES ERJ2GEJ 563 X (56K)	B	66.9/38.3
R308	7030009140	S.RES ERJ2GEJ 272 X (2.7K)	T	56.9/54.9
R311	7030010040	S.RES ERJ2GEJ-JPW	B	94.9/32.2
R317	7030005120	S.RES ERJ2GEJ 102 X (1K)	T	103.8/36.5
R319	7030005210	S.RES ERJ2GEJ 822 X (8.2K)	T	37.3/37.9
R320	7030005170	S.RES ERJ2GEJ 474 X (470K)	T	35.5/36.2
R328	7030010040	S.RES ERJ2GEJ-JPW	B	104.8/29.1
R334	7030009280	S.RES ERJ2GEJ 391 X	T	87.6/61.3
R337	7030010430	S.RES ERJ2GEJ 120 X (12K)	T	87.1/62.7
R338	7030009280	S.RES ERJ2GEJ 391 X	T	87.6/64.1
R339	7030010040	S.RES ERJ2GEJ-JPW	B	96.5/25.3
R340	7030005050	S.RES ERJ2GEJ 103 X (10K)	B	72.4/25.3
R350	7030005600	S.RES ERJ2GEJ 273 X (27K)	B	52.9/26.2
R351	7030005600	S.RES ERJ2GEJ 273 X (27K)	B	43.2/26.2
R352	7030007300	S.RES ERJ2GEJ 332 X (3.3K)	B	50.9/26.8
R353	7030005210	S.RES ERJ2GEJ 822 X (8.2K)	B	45.4/27.1
R354	7030005210	S.RES ERJ2GEJ 822 X (8.2K)	B	46.5/29.0
R355	7030005000	S.RES ERJ2GEJ 471 X (47K)	B	44.4/29.4
R394	7030010040	S.RES ERJ2GEJ-JPW	B	100.1/27.3
R395	7030010040	S.RES ERJ2GEJ-JPW	B	26.7/46.8
R478	7030007340	S.RES ERJ2GEJ 153 X (15K)	B	34.1/28.5
R479	7030005600	S.RES ERJ2GEJ 273 X (27K)	T	66.8/27.4
R483	7030007300	S.RES ERJ2GEJ 332 X (3.3K)	T	71.5/28.8
R484	7030007300	S.RES ERJ2GEJ 332 X (3.3K)	T	76.5/42.5
R485	7030010040	S.RES ERJ2GEJ-JPW	T	77.0/40.4
R486	7030005000	S.RES ERJ2GEJ 471 X (47K)	T	73.2/29.7
R488	7030007300	S.RES ERJ2GEJ 332 X (3.3K)	T	68.6/42.5
R489	7030007300	S.RES ERJ2GEJ 332 X (3.3K)	T	68.5/29.7
R490	7030005120	S.RES ERJ2GEJ 102 X (1K)	T	81.3/42.2
R492	7030005090	S.RES ERJ2GEJ 104 X (100K)	B	80.0/27.2
R500	7030010040	S.RES ERJ2GEJ-JPW	T	55.0/18.7
R504	7030005090	S.RES ERJ2GEJ 104 X (100K)	T	75.3/17.9
R505	7030005290	S.RES ERJ2GEJ 682 X (6.8K)	T	76.1/22.7
R506	7030005050	S.RES ERJ2GEJ 103 X (10K)	T	74.8/21.5
R613	7030005120	S.RES ERJ2GEJ 102 X (1K)	T	81.2/39.3
R614	7030007290	S.RES ERJ2GEJ 222 X (2.2K)	B	56.2/24.3
R615	7030005040	S.RES ERJ2GEJ 472 X (4.7K)	T	50.7/27.7
R619	7030005030	S.RES ERJ2GEJ 152 X (1.5K)	B	33.9/29.7
R621	7410001130	S.ARR EXB28V102JX	B	76.6/19.6

[MAIN-E UNIT] (For [High band] versions)

REF NO.	PARTS NO.	DESCRIPTION	M.	H/V LOCATION
R622	7030007570	S.RES ERJ2GEJ 122 X (1.2K)	B	83.8/21.6
R623	7030005090	S.RES ERJ2GEJ 104 X (100K)	B	50.7/26.1
R624	7030005090	S.RES ERJ2GEJ 104 X (100K)	T	83.2/11.6
R625	7030010040	S.RES ERJ2GEJ-JPW	B	96.1/20.1
R1003	7030007601	S.RES ERA3YKD 913V (91K)	B	72.6/9.4
R1004	7030006101	S.RES ERA3YED 183V (18K)	B	70.2/10.2
R1005	7030005120	S.RES ERJ2GEJ 102 X (1K)	T	112.3/16.5
R1006	7030005090	S.RES ERJ2GEJ 104 X (100K)	B	112.4/8.1
R1008	7030010040	S.RES ERJ2GEJ-JPW	T	124.9/24.8
R1009	7030005050	S.RES ERJ2GEJ 103 X (10K)	T	133.3/49.2
R1010	7030005050	S.RES ERJ2GEJ 103 X (10K)	T	128.6/23.8
R1012	7030005040	S.RES ERJ2GEJ 472 X (4.7K)	T	110.6/46.0
R1013	7030005240	S.RES ERJ2GEJ 473 X (47K)	T	114.7/49.0
R1014	7030005090	S.RES ERJ2GEJ 104 X (100K)	B	98.3/12.1
R1015	7030005120	S.RES ERJ2GEJ 102 X (1K)	B	115.3/22.8
R1016	7030005090	S.RES ERJ2GEJ 104 X (100K)	B	115.6/6.1
R1018	7030005090	S.RES ERJ2GEJ 104 X (100K)	T	111.7/7.0
R1020	7030005090	S.RES ERJ2GEJ 104 X (100K)	B	114.7/24.9
R1021	7030005120	S.RES ERJ2GEJ 102 X (1K)	B	116.5/6.1
R1022	7030005120	S.RES ERJ2GEJ 102 X (1K)	T	114.9/7.1
R1023	7030005050	S.RES ERJ2GEJ 103 X (10K)	B	125.2/15.7
R1024	7030007290	S.RES ERJ2GEJ 222 X (2.2K)	B	131.6/17.6
R1025	7030000480	S.RES MCR10EZHJ 6.8K (682)	B	129.4/47.0
R1026	7030000480	S.RES MCR10EZHJ 6.8K (682)	B	129.4/48.8
R1027	7030010040	S.RES ERJ2GEJ-JPW	T	113.7/16.5
R1028	7030004970	S.RES ERJ2GEJ 470 X (47K)	B	114.9/13.4
R1029	7030005120	S.RES ERJ2GEJ 102 X (1K)	T	115.3/10.5
R1030	7030005050	S.RES ERJ2GEJ 103 X (10K)	T	114.4/10.5
R1031	7030005050	S.RES ERJ2GEJ 103 X (10K)	B	117.8/7.7
R1032	7030005120	S.RES ERJ2GEJ 102 X (1K)	B	127.1/19.9
R1033	7030000480	S.RES MCR10EZHJ 6.8K (682)	B	129.4/45.2
R1034	7030005040	S.RES ERJ2GEJ 472 X (4.7K)	B	123.6/17.5
R1035	7030005050	S.RES ERJ2GEJ 103 X (10K)	T	107.8/42.5
R1036	7030005040	S.RES ERJ2GEJ 472 X (4.7K)	T	107.8/41.2
R1037	7030005090	S.RES ERJ2GEJ 104 X (100K)	T	95.9/13.3
R1038	7030005120	S.RES ERJ2GEJ 102 X (1K)	B	125.6/36.5
R1039	7030005090	S.RES ERJ2GEJ 104 X (100K)	B	113.7/12.9
R1040	7030005160	S.RES ERJ2GEJ 105 X (1M)	T	111.2/12.9
R1043	7030005160	S.RES ERJ2GEJ 105 X (1M)	B	112.0/11.0
R1044	7030005090	S.RES ERJ2GEJ 104 X (100K)	B	117.9/9.9
R1045	7030005050	S.RES ERJ2GEJ 103 X (10K)	B	120.4/17.1
R1046	7030005080	S.RES RR0510P-102-D (1K)	B	119.7/9.0
R1047	7030005050	S.RES ERJ2GEJ 102 X (10K)	B	119.4/18.6
R1048	7030009710	S.RES ERJ2GEJ 203 X (20K)	B	119.0/22.4
R1049	7030005040	S.RES ERJ2GEJ 472 X (4.7K)	B	116.7/19.7
R1050	7030007290	S.RES ERJ2GEJ 222 X (2.2K)	B	123.1/39.7
R1054	7030008270	S.RES RR0510P-104-D (100K)	B	119.7/9.9
R1055	7030005090	S.RES ERJ2GEJ 104 X (100K)	B	120.4/15.2
R1056	7030008270	S.RES RR0510P-104-D (100K)	B	118.8/10.8
R1057	7030005100	S.RES ERJ2GEJ 154 X (150K)	B	118.8/15.2
R1059	7410001130	S.ARR EXB28V102JX	T	69.7/14.8
R1060	7410001130	S.ARR EXB28V102JX	T	63.4/14.8
R1062	7030008270	S.RES RR0510P-104-D (100K)	B	116.0/14.8
R1068	7030005120	S.RES ERJ2GEJ 102 X (1K)	T	74.3/14.1
R1069	7030005120	S.RES ERJ2GEJ 102 X (1K)	T	72.6/14.1
R1070	7030005120	S.RES ERJ2GEJ 102 X (1K)	T	57.3/15.1
R1082	7410001130	S.ARR EXB28V102JX	T	56.9/6.7
R1083	7030005120	S.RES ERJ2GEJ 102 X (1K)	B	69.1/8.8
R1084	7410001130	S.ARR EXB28V102JX	T	61.7/6.1
R1085	7030005120	S.RES ERJ2GEJ 102 X (1K)	T	65.7/7.1
R1098	7510001730	S.THE ERTJOEP 473J	T	74.9/15.5
R1099	7030008270	S.RES RR0510P-104-D (100K)	T	72.5/15.5
R1100	7410001130	S.ARR EXB28V102JX	T	75.3/6.0
R1105	7030003860	S.RES ERJ3GE JPW V	T	127.8/48.9
R1108	7030005240	S.RES ERJ2GEJ 473 X (47K)	B	124.9/41.7
R1114	7030005120	S.RES ERJ2GEJ 102 X (1K)	T	65.7/6.2
R1115	7030005120	S.RES ERJ2GEJ 102 X (1K)	T	65.7/5.3
R1116	7030007300	S.RES ERJ2GEJ 332 X (3.3K)	T	73.7/15.0
R1119	7030003860	S.RES ERJ3GE JPW V	T	99.5/68.6
R1500	7030005310	S.RES ERJ2GEJ 124 X (120K)	T	34.0/14.3
R1501	7030005240	S.RES ERJ2GEJ 473 X (47K)	T	37.1/19.2
R1502	7030009290	S.RES ERJ2GEJ 562 X (5.6K)	T	38.0/19.2
R1503	7030008010	S.RES ERJ2GEJ 123 X (12K)	T	34.0/15.2
R1504	7030008300	S.RES ERJ2GEJ 184 X (180K)	T	31.8/18.8
R1505	7030007340	S.RES ERJ2GEJ 153 X (15K)	T	34.0/18.1
R15				

[MAIN-E UNIT] (For [High band] versions)

REF NO.	PARTS NO.	DESCRIPTION	M.	H/V LOCATION
R2020	7030010040	S.RES ERJ2GEJ-JPW	B	14.4/11.1
R2021	7030004980	S.RES ERJ2GEJ 101 X (100)	B	23.6/12.1
R2022	7030004980	S.RES ERJ2GEJ 101 X (100)	B	27.9/24.7
R2024	7030005240	S.RES ERJ2GEJ 473 X (47K)	B	26.6/21.6
R2026	7030004970	S.RES ERJ2GEJ 470 X (47)	B	27.9/22.9
R2028	7030005240	S.RES ERJ2GEJ 473 X (47K)	B	12.1/19.3
R2030	7030005240	S.RES ERJ2GEJ 473 X (47K)	B	11.0/11.7
R2031	7030005240	S.RES ERJ2GEJ 473 X (47K)	B	10.7/29.4
R2032	7030005240	S.RES ERJ2GEJ 473 X (47K)	B	24.9/17.4
R2034	7030005240	S.RES ERJ2GEJ 473 X (47K)	B	28.8/10.5
R2035	7030005240	S.RES ERJ2GEJ 473 X (47K)	B	26.7/14.9
R2036	7030004980	S.RES ERJ2GEJ 101 X (100)	T	26.8/11.9
R2037	7030007290	S.RES ERJ2GEJ 222 X (2.2K)	T	28.1/10.7
R2038	7030004970	S.RES ERJ2GEJ 470 X (47)	B	28.8/12.1
R2039	7030005240	S.RES ERJ2GEJ 473 X (47K)	B	24.1/9.5
R2040	7030005240	S.RES ERJ2GEJ 473 X (47K)	B	24.5/12.1
R2043	7410001140	S.ARR EXB28V104JX	T	15.6/26.7
R2044	7410001140	S.ARR EXB28V104JX	B	20.8/26.3
R2045	7410001140	S.ARR EXB28V104JX	B	27.0/22.6
R2046	7410001140	S.ARR EXB28V104JX	T	19.3/26.7
R2047	7410001140	S.ARR EXB28V104JX	B	10.9/14.5
R2048	7030005090	S.RES ERJ2GEJ 104 X (100K)	T	25.7/14.6
R2049	7030005090	S.RES ERJ2GEJ 104 X (100K)	B	21.8/15.6
R2050	7410001140	S.ARR EXB28V104JX	B	22.6/18.2
R2051	7410001140	S.ARR EXB28V104JX	T	9.9/17.6
R2052	7030005090	S.RES ERJ2GEJ 104 X (100K)	T	16.8/11.4
R2053	7030005090	S.RES ERJ2GEJ 104 X (100K)	B	16.0/14.5
R2056	7030010040	S.RES ERJ2GEJ-JPW	T	10.6/20.0
R2057	7030005090	S.RES ERJ2GEJ 104 X (100K)	T	10.4/22.9
R2058	7410001140	S.ARR EXB28V104JX	B	17.0/18.6
R2059	7030005090	S.RES ERJ2GEJ 104 X (100K)	T	10.4/23.8
R2060	7030005090	S.RES ERJ2GEJ 104 X (100K)	T	25.7/15.6
R2061	7030005090	S.RES ERJ2GEJ 104 X (100K)	B	14.7/12.6
R2062	7030005090	S.RES ERJ2GEJ 104 X (100K)	B	17.7/14.4
R2063	7030005090	S.RES ERJ2GEJ 104 X (100K)	B	22.1/23.4
R2064	7030005090	S.RES ERJ2GEJ 104 X (100K)	B	19.7/17.7
R2065	7030005030	S.RES ERJ2GEJ 152 X (1.5K)	B	13.8/6.8
R2076	7030010040	S.RES ERJ2GEJ-JPW	T	28.4/18.8
R2077	7030010040	S.RES ERJ2GEJ-JPW	T	28.7/16.4
R2086	7030004970	S.RES ERJ2GEJ 470 X (47)	T	17.3/7.3
R2087	7030004970	S.RES ERJ2GEJ 470 X (47)	T	18.9/7.0
R2088	7030004990	S.RES ERJ2GEJ 221 X (220)	T	19.9/7.0
R2089	7030004970	S.RES ERJ2GEJ 470 X (47)	T	21.9/7.0
R2090	7030010040	S.RES ERJ2GEJ-JPW	B	8.7/9.0
C1	4030011050	S.CER GRM31M3C2H3R0CY21L (GRM42-6 CJ)	B	8.4/66.6
C2	4030011070	S.CER GRM31M2C2H5R0CY21L (GRM42-6 CH)	B	7.4/58.6
C3	4030009500	S.CER C1608 CH 1H 0R5B-T	B	25.6/51.9
C4	4030009500	S.CER C1608 CH 1H 0R5B-T	B	16.4/51.9
C5	4030009500	S.CER C1608 CH 1H 0R5B-T	B	8.2/54.5
C6	4030011060	S.CER GRM31M2C2H4R0CY21L (GRM42-6 CH)	B	7.4/56.3
C7	4030011070	S.CER GRM31M2C2H5R0CY21L (GRM42-6 CH)	B	13.1/60.7
C8	4030011050	S.CER GRM31M3C2H3R0CY21L (GRM42-6 CJ)	B	19.5/60.7
C9	4030011050	S.CER GRM31M3C2H3R0CY21L (GRM42-6 CJ)	T	30.6/53.1
C10	4030017730	S.CER C1005 JB 1H 471K-T	B	18.1/48.1
C11	4030017730	S.CER C1005 JB 1H 471K-T	B	10.0/49.2
C12	4030017730	S.CER C1005 JB 1H 471K-T	T	39.4/54.4
C13	4030017420	S.CER C1005 CH 1H 470J-T	B	49.5/51.4
C14	4030019420	S.CER GRM31A7U2J102JW31D	B	34.9/55.5
C15	4030017360	S.CER C1005 CH 1H 030B-T	T	23.7/50.4
C20	4030017620	S.CER C1005 CH 1H 100C-T	B	30.6/40.5
C21	4030017360	S.CER C1005 CH 1H 030B-T	B	26.7/38.1
C22	4030017350	S.CER C1005 CH 1H 020B-T	B	32.0/37.5
C25	4030017420	S.CER C1005 CH 1H 470J-T	B	25.8/38.1
C26	4030017640	S.CER C1005 CH 1H 150J-T	B	33.4/40.5
C27	4030016930	S.CER C1005 JB 1A 104K-T	B	31.5/38.8
C28	4030017460	S.CER C1005 JB 1H 102K-T	B	32.5/36.2
C29	4030017360	S.CER C1005 CH 1H 030B-T	B	37.1/37.4
C30	4030017390	S.CER C1005 CH 1H 180J-T	B	39.2/37.7
C31	4030016930	S.CER C1005 JB 1A 104K-T	B	51.5/37.4
C32	4030017460	S.CER C1005 JB 1H 102K-T	B	41.3/40.7
C33	4030017420	S.CER C1005 CH 1H 470J-T	B	38.6/40.7
C34	4030017460	S.CER C1005 JB 1H 102K-T	B	37.7/40.7
C36	4030017460	S.CER C1005 JB 1H 102K-T	B	51.5/41.2
C37	4030017730	S.CER C1005 JB 1H 471K-T	B	49.0/42.7
C38	4030017460	S.CER C1005 JB 1H 102K-T	B	39.2/35.9
C39	4030017610	S.CER C1005 CH 1H 090C-T	B	52.8/40.2
C40	4030017540	S.CER C1005 CH 1H R75B-T	B	54.1/39.2
C41	4030017400	S.CER C1005 CH 1H 220J-T	B	66.9/39.2
C42	4030017460	S.CER C1005 JB 1H 102K-T	T	54.0/37.8
C43	4030016930	S.CER C1005 JB 1A 104K-T	B	54.1/38.3
C44	4030017560	S.CER C1005 CH 1H 2R5B-T	B	59.9/40.5
C45	4030017620	S.CER C1005 CH 1H 100C-T	B	55.5/42.0
C48	4030017420	S.CER C1005 CH 1H 470J-T	B	72.2/40.6
C49	4030017380	S.CER C1005 CH 1H 050B-T	B	75.9/39.2
C50	4030017460	S.CER C1005 JB 1H 102K-T	B	73.1/40.6
C51	4030017460	S.CER C1005 JB 1H 102K-T	T	72.4/41.1
C52	4030017620	S.CER C1005 CH 1H 100C-T	B	70.4/41.2
C53	4030016790	S.CER C1005 JB 1E 103K-T	B	71.3/42.8
C54	4030017730	S.CER C1005 JB 1H 471K-T	B	70.4/42.8
C57	4030017460	S.CER C1005 JB 1H 102K-T	B	74.6/36.7
C58	4030017460	S.CER C1005 JB 1H 102K-T	T	67.2/26.1
C59	4030017460	S.CER C1005 JB 1H 102K-T	T	66.9/22.7
C60	4030016790	S.CER C1005 JB 1E 103K-T	T	65.3/26.6
C61	4030017430	S.CER C1005 CH 1H 101J-T	T	61.6/23.1
C62	4030017400	S.CER C1005 CH 1H 220J-T	B	57.1/24.3
C63	4030017420	S.CER C1005 CH 1H 470J-T	T	60.3/14.3
C64	4030016790	S.CER C1005 JB 1E 103K-T	B	56.2/26.8

Eqv.= This component is equivalent to the REF No. component listed above, and may be substituted on parts orders and repairs.

[MAIN-E UNIT] (For [High band] versions)

REF NO.	PARTS NO.	DESCRIPTION	M.	H/V LOCATION
C65	4030016790	S.CER C1005 JB 1E 103K-T	T	58.2/19.6
C66	4030017460	S.CER C1005 JB 1H 102K-T	T	54.7/19.9
C67	4030017460	S.CER C1005 JB 1H 102K-T	B	58.4/21.3
C68	4030017680	S.CER C1005 CH 1H 820J-T	T	52.2/23.8
C69	4030017710	S.CER C1005 CH 1H 181J-T	T	54.0/20.3
C70	4030017430	S.CER C1005 CH 1H 101J-T	T	54.0/25.6
C71	4030016930	S.CER C1005 JB 1A 104K-T	T	57.4/29.0
C72	4030017730	S.CER C1005 JB 1H 471K-T	T	59.8/48.0
C74	4030017730	S.CER C1005 JB 1H 471K-T	B	11.2/50.5
C75	4030019560	S.CER GRM21BB31C106KE15L	T	61.6/25.3
C76	4030016790	S.CER C1005 JB 1E 103K-T	T	57.8/54.9
C77	4030017460	S.CER C1005 JB 1H 102K-T	T	56.8/50.7
C78	4030017730	S.CER C1005 JB 1H 471K-T	B	58.8/56.6
C79	4030016960	S.CER C1005 JB 1E 183K-T	T	62.4/55.0
C81	4030017460	S.CER C1005 JB 1H 102K-T	T	65.1/55.0
C82	4030011050	S.CER GRM31M3C2H3R0CY21L (GRM42-6 CJ)	T	34.9/65.2
C84	4030017420	S.CER C1005 CH 1H 470J-T	T	55.0/61.6
C85	4030017460	S.CER C1005 JB 1H 102K-T	T	56.0/61.6
C86	4030017710	S.CER C1005 CH 1H 181J-T	T	81.3/63.8
C87	4030017460	S.CER C1005 JB 1H 102K-T	T	79.8/68.8
C88	4030017730	S.CER C1005 JB 1H 471K-T	T	64.6/52.1
C89	4030017590	S.CER C1005 CH 1H 070C-T	B	87.3/57.5
C90	4030017590	S.CER C1005 CH 1H 070C-T	B	88.2/57.5
C92	4030017570	S.CER C1005 CH 1H 040B-T	B	89.9/58.0
C93	4030017590	S.CER C1005 CH 1H 070C-T	B	86.9/51.5
C96	4030017460	S.CER C1005 JB 1H 102K-T	B	87.8/56.3
C97	4030017730	S.CER C1005 JB 1H 471K-T	B	87.8/55.4
C98	4030017390	S.CER C1005 CH 1H 180J-T	B	83.5/48.7
C99	4030017730	S.CER C1005 JB 1H 471K-T	B	81.4/48.3
C100	4030017590	S.CER C1005 CH 1H 070C-T	B	91.2/34.9
C102	4030017590	S.CER C1005 CH 1H 070C-T	B	97.1/33.8
C103	4030017360	S.CER C1005 CH 1H 030B-T	B	98.5/32.4
C104	4030017460	S.CER C1005 JB 1H 102K-T	B	100.8/29.9
C105	4030017730	S.CER C1005 JB 1H 471K-T	B	97.6/28.9
C106	4030017420	S.CER C1005 CH 1H 470J-T	B	91.7/48.9
C107	4030017460	S.CER C1005 JB 1H 102K-T	T	80.2/51.7
C108	4030016790	S.CER C1005 JB 1E 103K-T	B	81.3/49.2
C109	4030017460	S.CER C1005 JB 1H 102K-T	B	95.8/35.3
C110	4030017730	S.CER C1005 JB 1H 471K-T	B	98.6/35.3
C112	4030016930	S.CER C1005 JB 1A 104K-T	T	100.8/37.1
C113	4030017520	S.CER C1005 CH 1H 0R3B-T	B	102.0/29.6
C114	4030017600	S.CER C1005 CH 1H 080C-T	B	98.3/26.1
C115	4030017620	S.CER C1005 CH 1H 100C-T	B	98.8/21.9
C116	4030017460	S.CER C1005 JB 1H 102K-T	B	107.5/30.0
C117	4030017730	S.CER C1005 JB 1H 471K-T	B	107.5/30.9
C118	4030017520	S.CER C1005 CH 1H 0R3B-T	B	102.8/32.0
C119	4030016790	S.CER C1005 JB 1E 103K-T	B	97.0/21.9
C120	4030017730	S.CER C1005 JB 1H 471K-T	B	97.9/21.9
C121	4030017590	S.CER C1005 CH 1H 070C-T	B	103.3/30.8
C122	4030017620	S.CER C1005 CH 1H 100C-T	B	107.5/31.8
C123	4030017600	S.CER C1005 CH 1H 080C-T	B	104.8/28.2
C124	4030017640	S.CER C1005 CH 1H 150J-T	B	105.0/20.8
C125	4030017420	S.CER C1005 CH 1H 470J-T	B	101.7/27.5
C126	4030017380	S.CER C1005 CH 1H 050B-T	B	95.6/23.7
C127	4030017640	S.CER C1005 CH 1H 150J-T	B	96.1/21.9
C128	4030017360	S.CER C1005 CH 1H 030B-T	B	99.2/27.3
C129	4030017520	S.CER C1005 CH 1H 0R3B-T	B	103.5/27.5
C131	4030017540	S.CER C1005 CH 1H R75B-T	B	106.4/27.2
C132	4030017460	S.CER C1005 JB 1H 102K-T	T	94.3/12.6
C133	4030017610	S.CER C1005 CH 1H 090C-T	B	105.4/22.8
C134	4030017600	S.CER C1005 CH 1H 080C-T	B	93.7/22.7
C135	4030016790	S.CER C1005 JB 1E 103K-T	T	78.3/21.0
C139	4030016930	S.CER C1005 JB 1A 104K-T	B	107.5/33.6
C140	4030017430	S.CER C1005 CH 1H 101J-T	B	81.2/18.9
C141	4030017460	S.CER C1005 JB 1H 102K-T	T	75.7/21.5
C143	4030017460	S.CER C1005 JB 1H 102K-T	T	78.9/22.2
C144	4030017420	S.CER C1005 CH 1H 470J-T	T	92.5/16.1
C146	4030021140	S.CER GRM31C2C1H683JA01L	T	84.7/22.9
Eqv.	4550000520	S.TAN TEESVA 1V 683M8R		
C147	4550003250	S.TAN TEESVA 1V 474M8R	T	80.5/22.9
Eqv.	4550007590	S.TAN F931V474MAABMA		
C148	4030019560	S.CER GRM21BB31C106KE15L	T	109.7/30.5
C151	4030016930	S.CER C1005 JB 1A 104K-T	B	75.3/18.1
C152	4030017420	S.CER C1005 CH 1H 470J-T	B	77.8/18.1
C153	4030017420	S.CER C1005 CH 1H 470J-T	B	78.1/16.2
C154	4030017420	S.CER C1005 CH 1H 470J-T	B	76.4/16.2
C155	4030017460	S.CER C1005 JB 1H 102K-T	B	81.7/16.7
C156	4030016790	S.CER C1005 JB 1E 103K-T	B	81.2/17.9
C157	4030017620	S.CER C1005 CH 1H 100C-T	B	72.4/24.4
C160				

[MAIN-E UNIT] (For [High band] versions)

REF NO.	PARTS NO.	DESCRIPTION	M.	H/V LOCATION
C314	4030016790	S.CER C1005 JB 1E 103K-T	T	110.5/33.8
C323	4030017620	S.CER C1005 CH 1H 100C-T	B	72.3/26.2
C332	4030017530	S.CER C1005 CH 1H 0R5B-T	B	84.9/50.0
C333	4030017420	S.CER C1005 CH 1H 470J-T	B	40.4/40.7
C334	4030017590	S.CER C1005 CH 1H 070C-T	B	94.9/68.3
C335	4030017630	S.CER C1005 CH 1H 120J-T	B	93.8/68.3
C336	4030017710	S.CER C1005 CH 1H 181J-T	B	62.0/68.7
C337	4030017460	S.CER C1005 JB 1H 102K-T	T	82.7/29.2
C340	4030017710	S.CER C1005 CH 1H 181J-T	B	107.7/28.7
C342	4550002980	S.TAN TEESVA 1C 225M8R	T	78.4/66.1
Eqv.	4550007390	S.TAN F931C225MAABMA		
C343	4030017460	S.CER C1005 JB 1H 102K-T	B	51.5/39.2
C344	4030017460	S.CER C1005 JB 1H 102K-T	B	54.2/68.0
C345	4030017730	S.CER C1005 JB 1H 471K-T	B	54.2/67.1
C346	4030017420	S.CER C1005 CH 1H 470J-T	B	66.0/68.7
C347	4030017460	S.CER C1005 JB 1H 102K-T	T	52.2/22.9
C348	4030017460	S.CER C1005 JB 1H 102K-T	T	59.3/20.5
C350	4030017920	S.CER C1005 JB 1A 683K-T	T	95.9/14.4
C357	4030016930	S.CER C1005 JB 1A 104K-T	T	105.1/36.1
C358	4030017340	S.CER C1005 CH 1H 010B-T	B	91.2/35.8
C366	4030017460	S.CER C1005 JB 1H 102K-T	B	97.0/64.4
C367	4030017730	S.CER C1005 JB 1H 471K-T	B	97.0/65.8
C368	4030017420	S.CER C1005 CH 1H 470J-T	B	97.0/67.3
C372	4030017730	S.CER C1005 JB 1H 471K-T	T	60.3/67.7
C376	4030017730	S.CER C1005 JB 1H 471K-T	B	88.7/49.5
C377	4030017460	S.CER C1005 JB 1H 102K-T	T	57.8/61.6
C383	4030016930	S.CER C1005 JB 1A 104K-T	T	36.4/36.2
C384	4030016930	S.CER C1005 JB 1A 104K-T	T	59.3/29.0
C385	4030016930	S.CER C1005 JB 1A 104K-T	B	54.9/28.9
C388	4030017730	S.CER C1005 JB 1H 471K-T	B	68.2/36.7
C390	4030017460	S.CER C1005 JB 1H 102K-T	B	75.0/40.6
C391	4030017420	S.CER C1005 CH 1H 470J-T	B	75.9/40.6
C392	4030017520	S.CER C1005 CH 1H 0R3B-T	B	60.3/39.2
C393	4030017550	S.CER C1005 CH 1H 1R5B-T	B	66.3/40.5
C394	4030016930	S.CER C1005 JB 1A 104K-T	B	50.9/28.8
C395	4030016930	S.CER C1005 JB 1A 104K-T	B	45.6/29.0
C396	4030016930	S.CER C1005 JB 1A 104K-T	T	55.8/29.0
C397	4030016790	S.CER C1005 JB 1E 103K-T	B	55.9/13.2
C398	4030016790	S.CER C1005 JB 1E 103K-T	B	48.6/27.3
C399	4030016790	S.CER C1005 JB 1E 103K-T	B	48.3/28.5
C400	4030017710	S.CER C1005 CH 1H 181J-T	T	81.2/37.6
C401	4030017340	S.CER C1005 CH 1H 010B-T	B	78.6/40.6
C402	4030011040	S.CER GRM31M4C2H2R0CY21L (GRM42-6 CK)	B	38.0/68.7
C404	4030011060	S.CER GRM31M2C2H4R0CY21L (GRM42-6 CH)	B	15.5/60.7
C408	4030017730	S.CER C1005 JB 1H 471K-T	B	23.9/48.1
C409	4030017460	S.CER C1005 JB 1H 102K-T	B	39.3/51.1
C411	4030017460	S.CER C1005 JB 1H 102K-T	T	42.2/55.4
C413	4030018860	S.CER C1005 JB 0J 105K-T	B	91.5/25.3
C416	4030017420	S.CER C1005 CH 1H 470J-T	B	93.4/25.3
C418	4030018890	S.CER C1005 JB 0J 224K-T	T	102.8/17.3
C420	4030011050	S.CER GRM31M3C2H3R0CY21L (GRM42-6 CJ)	B	21.7/60.7
C423	4030017570	S.CER C1005 CH 1H 040B-T	B	77.7/40.6
C429	4030017620	S.CER C1005 CH 1H 100C-T	B	61.9/42.0
C447	4030017730	S.CER C1005 JB 1H 471K-T	B	83.3/52.0
C448	4030017670	S.CER C1005 CH 1H 390J-T	B	87.8/49.5
C453	4030017420	S.CER C1005 CH 1H 470J-T	B	101.3/35.3
C454	4030017460	S.CER C1005 JB 1H 102K-T	B	100.4/35.3
C457	4030017420	S.CER C1005 CH 1H 470J-T	B	54.0/37.4
C458	4030017420	S.CER C1005 CH 1H 470J-T	T	63.8/50.8
C459	4030017420	S.CER C1005 CH 1H 470J-T	T	86.1/48.4
C460	4030017420	S.CER C1005 CH 1H 470J-T	T	64.9/49.8
C463	4030018820	S.CER C1005 JB 1H 561K-T	T	54.0/26.5
C466	4030017420	S.CER C1005 CH 1H 470J-T	T	62.7/49.8
C467	4030017420	S.CER C1005 CH 1H 470J-T	T	88.4/10.4
C471	4030017420	S.CER C1005 CH 1H 470J-T	B	103.7/19.2
C624	4030017460	S.CER C1005 JB 1H 102K-T	B	81.2/26.7
C628	4030017590	S.CER C1005 CH 1H 070C-T	T	63.3/36.2
C629	4030017530	S.CER C1005 CH 1H 0R5B-T	T	66.8/29.7
C630	4030016790	S.CER C1005 JB 1E 103K-T	T	66.8/28.8
C631	4030016790	S.CER C1005 JB 1E 103K-T	T	68.6/41.6
C632	4030016790	S.CER C1005 JB 1E 103K-T	T	76.5/41.6
C633	4030016930	S.CER C1005 JB 1A 104K-T	T	81.3/43.1
C634	4030016930	S.CER C1005 JB 1A 104K-T	T	80.0/41.2
C635	4030016790	S.CER C1005 JB 1E 103K-T	T	71.5/29.7
C637	4030017600	S.CER C1005 CH 1H 080C-T	T	72.3/36.2
C638	4030017460	S.CER C1005 JB 1H 102K-T	T	83.5/42.2
C639	4030016930	S.CER C1005 JB 1A 104K-T	T	46.8/25.7
C640	4030017040	S.CER C1005 JB 1A 333K-T	B	37.5/26.7
C641	4030018890	S.CER C1005 JB 0J 224K-T	B	76.3/27.1
C642	4030018890	S.CER C1005 JB 0J 224K-T	B	77.5/27.0
C643	4030017430	S.CER C1005 CH 1H 101J-T	B	75.5/27.9
C644	4030019560	S.CER GRM21BB31C106KE15L	B	81.7/20.4
C645	4030016930	S.CER C1005 JB 1A 104K-T	B	30.0/15.7
C646	4030017460	S.CER C1005 JB 1H 102K-T	T	84.7/10.0
C647	4030016790	S.CER C1005 JB 1E 103K-T	B	59.1/27.7
C1003	4030017460	S.CER C1005 JB 1H 102K-T	T	133.3/63.5
C1005	4030018980	S.CER C1608 JB 1H 104K-T	B	100.1/11.8
C1007	4030017460	S.CER C1005 JB 1H 102K-T	T	100.1/12.1
C1008	4510009680	S.ELE EEEFK1E471P	B	110.2/52.6
C1010	4030017460	S.CER C1005 JB 1H 102K-T	B	106.5/59.0
C1011	4030016930	S.CER C1005 JB 1A 104K-T	B	93.9/12.1
C1012	4030017420	S.CER C1005 CH 1H 470J-T	B	117.5/16.6
C1014	4030017460	S.CER C1005 JB 1H 102K-T	T	116.6/27.5
C1015	4030017460	S.CER C1005 JB 1H 102K-T	T	114.9/8.0
C1017	4030017460	S.CER C1005 JB 1H 102K-T	B	122.5/64.9
C1018	4030017460	S.CER C1005 JB 1H 102K-T	T	133.3/45.0
C1019	4510009250	S.ELE EEEFK1C471P	B	130.5/34.8
C1022	4030017420	S.CER C1005 CH 1H 470J-T	B	105.5/59.0
C1023	4030017460	S.CER C1005 JB 1H 102K-T	B	113.4/58.8
C1024	4030017440	S.CER C1005 CH 1H 221J-T	B	113.4/59.7
C1025	4030017510	S.CER C1005 CH 1H 680J-T	B	113.4/60.6
C1026	4030019120	S.CER GRM188B31E105KA75D	T	115.8/49.5

Eqv.= This component is equivalent to the REF No. component listed above, and may be substituted on parts orders and repairs.

[MAIN-E UNIT] (For [High band] versions)

REF NO.	PARTS NO.	DESCRIPTION	M.	H/V LOCATION
C1028	4030017460	S.CER C1005 JB 1H 102K-T	B	117.4/6.1
C1029	4030017460	S.CER C1005 JB 1H 102K-T	B	114.9/12.6
C1031	4030017460	S.CER C1005 JB 1H 102K-T	T	115.0/16.9
C1032	4030016930	S.CER C1005 JB 1A 104K-T	B	123.0/16.6
C1033	4510009680	S.ELE EEEFK1E471P	B	120.0/29.1
C1034	4030018860	S.CER C1005 JB 0J 105K-T	B	131.6/16.6
C1035	4030016790	S.CER C1005 JB 1E 103K-T	B	131.6/18.7
C1036	4030018980	S.CER C1608 JB 1H 104K-T	T	128.4/46.9
C1037	4030019560	S.CER GRM21BB31C106KE15L	B	129.4/43.4
C1038	4030011600	S.CER C1608 JB 1E 104K-T	T	110.5/48.7
C1039	4510009680	S.ELE EEEFK1E471P	B	117.0/41.7
C1040	4030019560	S.CER GRM21BB31C106KE15L	B	116.7/22.2
C1042	4030016930	S.CER C1005 JB 1A 104K-T	B	118.1/22.4
C1043	4030016930	S.CER C1005 JB 1A 104K-T	T	114.9/16.0
C1045	4030017460	S.CER C1005 JB 1H 102K-T	T	114.9/14.2
C1046	4030018860	S.CER C1005 JB 0J 105K-T	T	114.9/15.1
C1048	4030018900	S.CER C1005 JB 0J 474K-T	B	126.7/18.6
C1050	4030018860	S.CER C1005 JB 0J 105K-T	B	125.2/16.6
C1051	4030017460	S.CER C1005 JB 1H 102K-T	B	122.1/48.2
C1052	4030016930	S.CER C1005 JB 1A 104K-T	T	127.8/40.1
C1053	4030019560	S.CER GRM21BB31C106KE15L	T	127.8/44.5
C1056	4030018860	S.CER C1005 JB 0J 105K-T	T	111.2/11.7
C1057	4030016930	S.CER C1005 JB 1A 104K-T	B	118.7/17.1
C1058	4030019560	S.CER GRM21BB31C106KE15L	T	105.5/44.4
C1059	4030017460	S.CER C1005 JB 1H 102K-T	T	107.7/46.3
C1060	4030017460	S.CER C1005 JB 1H 102K-T	B	126.4/39.8
C1061	4030017460	S.CER C1005 JB 1H 102K-T	T	107.7/37.4
C1062	4030017460	S.CER C1005 JB 1H 102K-T	B	120.7/22.9
C1063	4030019560	S.CER GRM21BB31C106KE15L	B	126.9/22.2
C1064	4030019560	S.CER GRM21BB31C106KE15L	B	121.6/36.0
C1065	4030017460	S.CER C1005 JB 1H 102K-T	B	120.2/35.6
C1066	4030018860	S.CER C1005 JB 0J 105K-T	B	124.9/39.7
C1070	4030017440	S.CER C1005 CH 1H 221J-T	B	120.4/16.2
C1071	4030016930	S.CER C1005 JB 1A 104K-T	B	120.4/10.8
C1074	4030017460	S.CER C1005 JB 1H 102K-T	B	73.9/10.4
C1075	4030017460	S.CER C1005 JB 1H 102K-T	B	70.7/14.4
C1076	4030017460	S.CER C1005 JB 1H 102K-T	B	69.7/14.4
C1077	4030017460	S.CER C1005 JB 1H 102K-T	B	68.8/14.4
C1081	4030016930	S.CER C1005 JB 1A 104K-T	B	117.2/15.2
C1082	4030016930	S.CER C1005 JB 1A 104K-T	B	114.8/14.6
C1092	4030016930	S.CER C1005 JB 1A 104K-T	B	75.8/14.4
C1098	4030018860	S.CER C1005 JB 0J 105K-T	T	53.4/16.3
C1100	4030017460	S.CER C1005 JB 1H 102K-T	B	75.8/9.1
C1101	4030016930	S.CER C1005 JB 1A 104K-T	T	78.2/8.0
C1102	4030017420	S.CER C1005 CH 1H 470J-T	B	71.6/6.6
C1119	4030017420	S.CER C1005 CH 1H 470J-T	B	65.2/6.9
C1133	4030016790	S.CER C1005 JB 1E 103K-T	T	78.2/5.7
C1135	4030017460	S.CER C1005 JB 1H 102K-T	T	73.9/16.8
C1136	4030016930	S.CER C1005 JB 1A 104K-T	T	71.6/15.5
C1142	4030016930	S.CER C1005 JB 1A 104K-T	B	117.6/11.8
C1143	4030018980	S.CER C1608 JB 1H 104K-T	B	93.8/9.4
C1500	4030016930	S.CER C1005 JB 1A 104K-T	T	35.6/14.3
C1501	4030018860	S.CER C1005 JB 0J 105K-T	T	34.0/16.3
C1502	4030019990	S.CER C1005 JB 1C 104K-T	T	35.2/15.7
C1503	4030018090	S.CER C1005 JB 1E 822K-T	T	32.7/16.8
C1504	4030017430	S.CER C1005 CH 1H 101J-T	T	32.3/18.0
C1505	4030018860	S.CER C1005 JB 0J 105K-T	B	30.6/17.2
C1506	4030020120	S.CER C1005 JB 0J 225M-T	T	32.4/19.3
C1507	4030018860	S.CER C1005 JB 0J 105K-T	B	31.9/18.0
C1511	4030017460	S.CER C1005 JB 1E 103K-T	B	35.0/23.3
C1512	4030018860	S.CER C1005 JB 0J 105K-T	B	36.3/24.3
C1515	4030018860	S.CER C1005 JB 0J 105K-T	T	36.2/19.6
C1516	4030017710	S.CER C1005 CH 1H 181J-T	T	37.6/20.7
C1517	4030018860	S.CER C1005 JB 0J 105K-T	B	37.9/23.0
C1518	4030016930	S.CER C1005 JB 1A 104K-T	B	38.8/23.0
C1519	4030020000	S.CER C1005 JB 1A 105K-T	B	42.7/22.2
C1520	4030020000	S.CER C1005 JB 1A 105K-T	B	41.8/22.2
C1521	4030020000	S.CER C1005 JB 1A 105K-T	B	40.9/22.1
C1522	4030020000	S.CER C1005 JB 1A 105K-T	B	42.8/20.3
C1523	4030017900	S.CER C1005 JB 1E 123K-T	T	42.6/20.4

[MAIN-E UNIT] (For [High band] versions)

REF NO.	PARTS NO.	DESCRIPTION	M.	H/V LOCATION
C2041	4030018910	S.CER C1608 JB 0J 475K-T	T	11.1/14.5
C2042	4030016930	S.CER C1005 JB 1A 104K-T	T	10.1/14.8
C2044	4030016790	S.CER C1005 JB 1E 103K-T	T	26.4/19.9
C2045	4030016930	S.CER C1005 JB 1A 104K-T	B	26.6/23.4
C2046	4030016930	S.CER C1005 JB 1A 104K-T	B	26.6/23.4
C2047	4030016930	S.CER C1005 JB 1A 104K-T	B	26.6/20.7
C2048	4030016930	S.CER C1005 JB 1A 104K-T	B	26.6/22.5
C2049	4030017420	S.CER C1005 CH 1H 470J-T	B	25.7/9.5
C2050	4030017620	S.CER C1005 CH 1H 100C-T	B	26.7/15.8
C2051	4030016930	S.CER C1005 JB 1A 104K-T	B	13.6/29.4
C2052	4030016930	S.CER C1005 JB 1A 104K-T	B	25.5/15.3
C2053	4030017460	S.CER C1005 JB 1H 102K-T	B	27.4/10.4
C2054	4030016930	S.CER C1005 JB 1A 104K-T	T	25.5/12.4
C2055	4030017400	S.CER C1005 CH 1H 220J-T	B	11.0/20.3
C2056	4030017380	S.CER C1005 CH 1H 050B-T	T	27.2/10.7
C2057	4030016930	S.CER C1005 JB 1A 104K-T	B	24.1/10.4
C2058	4030016790	S.CER C1005 JB 1E 103K-T	B	28.8/13.7
C2062	4030018860	S.CER C1005 JB 0J 105K-T	T	9.4/20.1
C2063	4030017420	S.CER C1005 CH 1H 470J-T	T	2.1/14.7
C2064	4030017420	S.CER C1005 CH 1H 470J-T	T	2.5/13.5
C2065	4030017420	S.CER C1005 CH 1H 470J-T	T	3.8/13.0
C2066	4030017420	S.CER C1005 CH 1H 470J-T	T	6.5/16.5
C2067	4030017420	S.CER C1005 CH 1H 470J-T	T	7.5/24.0
C2069	4030017420	S.CER C1005 CH 1H 470J-T	T	27.5/17.2
C2070	4030016930	S.CER C1005 JB 1A 104K-T	B	21.0/12.5
C2071	4030016930	S.CER C1005 JB 1A 104K-T	B	21.7/19.7
C2072	4030016930	S.CER C1005 JB 1A 104K-T	B	17.2/23.8
C2073	4030016930	S.CER C1005 JB 1A 104K-T	B	20.2/16.0
C2076	4030016930	S.CER C1005 JB 1A 104K-T	T	7.7/27.1
C2077	4030019610	S.CER GRM155B31A105KE15D	B	41.2/6.1
C2078	4030017460	S.CER C1005 JB 1H 102K-T	B	39.8/9.0
C2079	4030017460	S.CER C1005 JB 1H 102K-T	B	38.2/9.0
C2080	4030016790	S.CER C1005 JB 1E 103K-T	B	36.7/5.3
C2081	4550007730	S.TAN TEESVJ 0J 106M8R	B	36.7/7.0
Eqv.	4550008380	S.TAN TMCJ0J106MTRF		
C2084	4030017420	S.CER C1005 CH 1H 470J-T	T	35.0/12.4
C2085	4030017420	S.CER C1005 CH 1H 470J-T	T	34.1/11.6
C2086	4030017420	S.CER C1005 CH 1H 470J-T	T	22.0/5.4
C2087	4030017420	S.CER C1005 CH 1H 470J-T	T	17.3/5.7
C2088	4030017420	S.CER C1005 CH 1H 470J-T	T	17.3/8.9
C2089	4030017420	S.CER C1005 CH 1H 470J-T	T	18.9/9.5
C2090	4030017420	S.CER C1005 CH 1H 470J-T	T	21.2/8.6
C2091	4030017420	S.CER C1005 CH 1H 470J-T	T	36.5/12.1
C2092	4030017460	S.CER C1005 JB 1H 102K-T	T	30.0/23.0
J1001	6510014961	S.CON B2B-ZR-SM4-TF(LF)(SN)	T	130.5/27.3
J1002	6450000140	CON HSJ0807-01-010		
J1003	6510022891	S.CON B13B-ZR-SM4-TF(LF)(SN)	T	120.0/17.2
J1004	6510027960	S.CON 04-6294-040-000-800	T	67.5/10.6
S1001	2260003180	S.SWI MINISMD050F-2 CN <UDX>	T	114.1/33.8
W1	7030012290	JUM RDS2T0R0		
W2	8900011863	CAB OPC-1195C <TJM>		
EP1	6910018460	S.BEA MMZ1005Y102C-T	B	107.5/32.7
EP4	6910010280	BEA HF70BB9.5X10.4X4.9		
EP5	6910010280	BEA HF70BB9.5X10.4X4.9		
EP7	6910018460	S.BEA MMZ1005Y102C-T	B	74.2/19.4
EP8	6910018460	S.BEA MMZ1005Y102C-T	B	80.8/16.7
EP13	6910018460	S.BEA MMZ1005Y102C-T	B	100.1/25.3
EP1003	6910016330	S.BEA MMZ1005S 601CT-S	B	42.8/19.2
EP1004	6910016330	S.BEA MMZ1005S 601CT-S	B	42.7/15.8
EP1005	6910016330	S.BEA MMZ1005S 601CT-S	T	43.1/15.8
EP1006	6910018460	S.BEA MMZ1005Y102C-T	T	39.6/13.4
EP2001	6910016330	S.BEA MMZ1005S 601CT-S	B	22.8/5.3
EP2005	6910016330	S.BEA MMZ1005S 601CT-S	B	24.6/23.8
EP2007	6910016330	S.BEA MMZ1005S 601CT-S	T	26.1/20.8
EP2008	6910015970	S.BEA MMZ1608B 301CT-AS	T	36.1/8.9
EP2009	6910018460	S.BEA MMZ1005Y102C-T	B	30.7/10.8
EP2010	6910018460	S.BEA MMZ1005Y102C-T	T	24.9/5.7

Eqv.= This component is equivalent to the REF No. component listed above, and may be substituted on parts orders and repairs.

[MAIN-F UNIT] (For [350 MHz band] versions)

REF NO.	PARTS NO.	DESCRIPTION	M.	H/V LOCATION
IC2	1110002751	S.IC TA75S01F(TE85RF)	T	60.0/54.9
IC3	1150002231	IC RA55H3340M-121		
IC4	1110007320	S.IC NJM2591V-TE1-#ZZZB	T	57.8/24.7
IC5	1110006230	S.IC NJM2711F-TE1-#ZZZB	T	37.5/29.3
IC7	1130011741	S.IC TC7W66FK(TE85LF)	B	85.8/12.3
IC8	1130015271	S.IC AK1541P4-L	B	78.2/23.7
IC1001	1180003680	S.REG XC6408EN22PPR-G	B	96.9/10.8
IC1002	1180003500	S.REG NJM7808DL1A-TE1-#FZZB	T	123.3/45.7
IC1004	1110002751	S.IC TA75S01F(TE85RF)	B	119.7/13.0
IC1009	1110003091	IC LA4425A-E		
IC1010	1110007920	S.IC SC-1445-E2	B	37.5/16.8
IC2001	1180003680	S.REG TPS62204DBVR	B	32.3/6.5
IC2002	1190002900	S.IC ADS7886SDCKR	B	14.4/9.3
IC2007	1140013290	S.IC TMS320VC5509AZHH <FE>	T	18.0/18.4
IC2008	1130015620	S.IC EN25Q40-100GIP <MSK>	B	12.5/25.3
IC2009	1110006230	S.IC NJM2711F-TE1-#ZZZB	B	26.7/12.7
IC2010	1180003600	S.REG NJM2871BF05-TE1-#ZZZB	B	39.0/6.8
Q1	1590004090	S.TRA LDTC114YET1G <SLVJ>	B	47.2/27.1
Q2	1580000731	S.FET 3SK293(TE85LF)	B	41.5/38.7
Q3	1560000541	S.FET 2SK880-Y(T5R1COMF)	T	77.2/24.5
Q4	1530002851	S.TRA 2SC4116-BL(TE85RF)	B	67.9/25.4
Q5	1530002851	S.TRA 2SC4116-BL(TE85RF)	T	44.9/25.3
Q6	1590004090	S.TRA LDTC114YET1G <SLVJ>	T	62.2/52.2
Q7	1560000841	S.FET 2SK1829(TE85RF)	T	33.7/39.7
Q8	1530002680	S.TRA 2SC3357-T1	B	90.4/52.8
Q9	1560001360	S.FET 2SK3019-TL	T	52.2/26.3
Eqv.	1560001840	S.FET 2SK3107-T1-AT		
Eqv.	1560001860	S.FET 2SK1824-T1-A		
Q10	1530003311	S.TRA 2SC5107-O(TE85RF)	B	92.8/33.1
Q11	1530003311	S.TRA 2SC5107-O(TE85RF)	B	100.5/31.7
Q12	1530004110	S.TRA MT3S37T(TE85LF)	B	97.6/30.4
Q13	1590004090	S.TRA LDTC114YET1G <SLVJ>	B	57.6/27.2
Q14	1530003311	S.TRA 2SC5107-O(TE85RF)	T	64.8/24.9
Q15	1590004500	S.TRA DMC561040R	T	101.0/34.4
Q16	1590004090	S.TRA LDTC114YET1G <SLVJ>	T	105.9/37.9
Q17	1530002851	S.TRA 2SC4116-BL(TE85RF)	T	107.7/33.4
Q18	1590004090	S.TRA LDTC114YET1G <SLVJ>	T	81.5/40.8
Q19	1580000731	S.FET 3SK293(TE85LF)	B	71.4/38.4
Q20	1530002851	S.TRA 2SC4116-BL(TE85RF)	T	60.0/49.8
Q21	1590004090	S.TRA LDTC114YET1G <SLVJ>	T	49.5/24.8
Q23	1530002921	S.TRA 2SC4226-T1 Y25 (R25)	B	105.2/30.9
Q24	1530002921	S.TRA 2SC4226-T1 Y25 (R25)	B	98.3/24.2
Q25	1530003260	S.TRA 2SC5006-T1	B	84.9/51.5
Q28	1590004090	S.TRA LDTC114YET1G <SLVJ>	T	103.7/38.0
Q1001	1590004090	S.TRA LDTC114YET1G <SLVJ>	T	110.6/44.1
Q1003	1550000190	S.FET 2SJ506STR-E	T	115.3/45.4
Q1004	1590004090	S.TRA LDTC114YET1G <SLVJ>	T	114.0/26.7
Q1005	1590004090	S.TRA LDTC114YET1G <SLVJ>	T	114.0/24.7
Q1007	1590004090	S.TRA LDTC114YET1G <SLVJ>	B	116.3/8.1
Q1008	1590000990	S.TRA DTC363EK T146	B	128.9/17.8
Q1009	1590004920	S.FET 2SJ145-T111-1D	B	113.8/11.1
Q1010	1590004090	S.TRA LDTC114YET1G <SLVJ>	B	116.1/10.9
Q1011	1540000550	S.TRA 2SD1664 T100Q	B	125.1/47.6
Eqv.	1540000770	S.TRA 2SD1664L-Q-AB3-R <SLVJ>		
Q1012	1590004090	S.TRA LDTC114YET1G <SLVJ>	B	130.9/20.7
Q1013	1510000920	S.TRA 2SA1577 T106 Q	T	107.7/44.3
Q1014	1520000460	S.TRA 2SB1132 T100 R	B	123.5/21.1
Eqv.	1520000910	S.TRA 2SB1132L-R-AB3-R <SLVJ>		
Q1015	1590004590	S.TRA DMC506010R	T	118.9/20.4
Q1016	1590004090	S.TRA LDTC114YET1G <SLVJ>	T	107.8/37.5
Q1017	1520000460	S.TRA 2SB1132 T100 R	T	120.1/35.2
Eqv.	1520000910	S.TRA 2SB1132L-R-AB3-R <SLVJ>		
Q1018	1590004090	S.TRA LDTC114YET1G <SLVJ>	B	126.4/43.3
Q1019	1590004590	S.TRA DMC506010R	B	123.8/37.5
Q1021	1590004090	S.TRA LDTC114YET1G <SLVJ>	B	126.4/41.3
Q2001	1590004040	S.TRA LDTA123YET1G <SLVJ>	B	26.9/26.6
D2	1750001910	S.DIO HVD144AKRF-E	B	52.6/28.5
D3	1750001910	S.DIO HVD144AKRF-E	B	52.6/27.3
D4	1750000711	S.VAR HVC350BTRF-E	B	36.0/40.2
D5	1750002060	S.DIO RN752T-E21	T	26.5/53.3
D7	1750001910	S.DIO HVD144AKRF-E	B	25.3/45.3
D8	1750001910	S.DIO HVD144AKRF-E	B	43.4/27.1
D9	1750001910	S.DIO HVD144AKRF-E	B	43.4/28.4
D10	1750000711	S.VAR HVC350BTRF-E	B	55.5/39.9
D11	1750001820	S.DIO LRB706F-40T1G <SLVJ>	B	8.2/49.9
D12	1750001820	S.DIO LRB706F-40T1G <SLVJ>	B	22.8/49.9
D13	1750001910	S.DIO HVD144AKRF-E	T	68.3/28.1
D14	1750001910	S.DIO HVD144AKRF-E	T	69.5/28.1
D15	1790001261	S.DIO MA2S077G0L	B	82.2/39.2
D16	1750000711	S.VAR HVC350BTRF-E	B	106.7/20.3
D17	1750001910	S.DIO HVD144AKRF-E	T	70.6/41.6
D18	1750001910	S.DIO HVD144AKRF-E	T	74.5/41.6
D19	1750000711	S.VAR HVC350BTRF-E	B	61.9/39.9
D20	1750000711	S.VAR HVC350BTRF-E	B	28.0/40.2
D21	1750000711	S.VAR HVC350BTRF-E	B	36.0/41.6
D22	1750000711	S.VAR HVC350BTRF-E	B	28.0/41.6
D23	1750000711	S.VAR HVC350BTRF-E	B	52.8/42.6
D24	1750002060	S.DIO RN752T-E21	T	35.1/56.7
D25	1750000581	S.DIO 1SV307(TPH3F)	B	83.5/42.1
D26	1750001650	S.VAR 1SV309(TPH3F)	B	101.8/25.9
D29	1750001820	S.DIO LRB706F-40T1G <SLVJ>	B	19.2/49.9
D33	1750000711	S.VAR HVC350BTRF-E	B	97.8/20.5
D62	1750000711	S.VAR HVC350BTRF-E	B	91.7/22.8
D64	1750000711	S.VAR HVC350BTRF-E	B	106.7/21.5
D66	1750000370	S.DIO DA221 TL	T	33.7/37.1
D67	1750002170	S.DIO DB2S31400L	T	31.8/39.7
D1002	1790000700	DIO DSA3A1		
D1003	1750000370	S.DIO DA221 TL	B	114.0/8.2
D1004	1750000370	S.DIO DA221 TL	B	114.1/6.1
D1005	1750000370	S.DIO DA221 TL	T	113.2/7.4
D1006	1750000370	S.DIO DA221 TL	T	113.0/10.3

M.=Mounted side (T: Mounted on the Top side, B: Mounted on the Bottom side) S.=Surface mount

[MAIN-F UNIT] (For [350 MHz band] versions)

REF NO.	PARTS NO.	DESCRIPTION	M.	H/V LOCATION
D1007	1750001810	S.DIO L1SS400T1G <SLVJ>	B	129.0/20.7
D1008	1750000370	S.DIO DA221 TL	B	124.0/43.3
D2002	1750002170	S.DIO DB2S31400L	T	24.9/18.0
D2003	1750002170	S.DIO DB2S31400L	B	10.7/30.5
D2004	1750002170	S.DIO DB2S31400L	B	22.1/21.4
D2005	1750002170	S.DIO DB2S31400L	B	17.5/26.3
D2006	1750002170	S.DIO DB2S31400L	T	12.0/25.3
D2008	1750002020	S.DIO DA2S10100L	T	100.3/6.5
F11	2020002570	CER LTM450HW <JJE>		
F12	2020002410	CER LTM450FW <JJE>		
F13	2020002610	S.CER LTUCG450G <JJE>	T	34.9/29.0
F14	2030000870	S.MON MFT46.3P3 46.350 MHz (FL-442)	T	66.9/34.9
F15	2010002760	S.XTA MFT46.3J 46.350 MHz (FL-448)	T	75.8/34.9
F16	2040001440	S.LC NFE31PT152Z1E9L (NFM60R20T152)	B	97.7/62.2
F17	2040001440	S.LC NFE31PT152Z1E9L (NFM60R20T152)	B	97.7/58.9
F18	2040001440	S.LC NFE31PT152Z1E9L (NFM60R20T152)	B	97.7/55.4
X1	6070000310	S.DIS JTBM450CX70 <JJE>	B	51.4/22.5
X2	6050012380	S.XTA CR-826 DSA535SD 15.3 MHz	B	71.5/21.0
X2001	6050013170	S.XTA CR-914 TTS18VSE-A11 12.288 MHz	B	27.0/18.2
L1	6200010150	S.COI AS080340-15N	B	8.4/62.7
L2	6200010150	S.COI AS080340-15N	B	12.9/55.5
L3	6200010150	S.COI AS080340-15N	B	20.7/55.5
L4	6200013100	S.COI 0.45-1.5-5TL 18.3N <COMO>	T	31.1/50.5
L5	6200010420	S.COI FHW1210HC 1R0JGT <JJE>	T	38.5/58.4
L6	6200010150	S.COI AS080340-15N	B	27.3/55.5
L7	6200012870	S.COI 0.30-1.4-5TR 23.5N <COMO>	B	28.8/37.8
L8	6200012870	S.COI 0.30-1.4-5TR 23.5N <COMO>	B	35.2/37.8
L9	6200012170	S.COI MLG1608S R18J-T	B	65.8/24.7
L10	6200011690	S.COI C2520C-12NG-A	B	49.0/39.8
L11	6200011690	S.COI C2520C-12NG-A	B	57.8/40.5
L12	6200012170	S.COI MLG1608S R18J-T	B	62.3/22.4
L13	6200007891	S.COI ELJRF 27NJFB	T	85.1/29.9
L16	6200010150	S.COI AS080340-15N	B	38.2/65.2
L17	6200005581	S.COI ELJRE 2N2ZFA	B	85.4/57.9
L18	6200005701	S.COI ELJRE 22NGFA	B	88.1/58.9
L19	6200005711	S.COI ELJRE 27NGFA	B	89.9/56.0
L20	6200010090	S.COI ELJND R82JF	B	68.9/40.9
L21	6200005721	S.COI ELJRE 33NGFA	B	90.8/33.1
L22	6200005721	S.COI ELJRE 33NGFA	B	99.5/33.8
L23	6200005701	S.COI ELJRE 22NGFA	B	84.9/53.2
L27	6200007370	S.COI ELJFC R82K-F	B	103.2/21.4
L28	6200011860	S.COI LQW18ANR47G00D	T	94.7/17.3
L36	6200006991	S.COI ELJRE 56NGFA	B	73.5/38.5
L37	6200006981	S.COI ELJRE R10GFA	T	86.2/62.9
L38	6200014300	S.COI C36-4.7J <COMO>	B	102.6/24.9
L39	6200013710	S.COI C36-8NH <COMO>	B	92.9/20.2
L41	6200005721	S.COI ELJRE 33NGFA	B	95.8/29.8
L53	6200005721	S.COI ELJRE 33NGFA	B	78.0/39.2
L54	6200007370	S.COI ELJFC R82K-F	T	100.0/30.4
L55	6200004741	S.COI NLV25T-1R2J	B	103.7/33.8
L56	6200011690	S.COI C2520C-12NG-A	B	64.2/40.5
L57	6200011860	S.COI LQW18ANR47G00D	B	92.6/24.0
L58	6200011860	S.COI LQW18ANR47G00D	B	105.9/19.1
L1001	6200004660	S.COI MLF1608A 1R8K-T	T	79.8/13.3
L2001	6200014160	S.COI VLFC402R-100M1R0-2	T	35.9/71.6
L2002	6200007830	S.COI ELJFC 4R7K-F	B	30.6/11.7
R1	7030000620	S.RES MCR10EZHZ 100 K (104)	B	12.3/65.5
R4	7030003560	S.RES ERJ3GEYJ 103 V (10K)	B	16.4/50.6
R5	7030005220	S.RES ERJ2GEJ 223 X (22K)	B	11.2/49.6
R6	7030005220	S.RES ERJ2GEJ 223 X (22K)	B	19.8/48.1
R7	7030003560	S.RES ERJ3GEYJ 103 V (10K)	B	8.2/53.2
R8	7030006070	S.RES ERJ12VJ101U (100)	B	45.7/51.9
R9	7030003560	S.RES ERJ3GEYJ 103 V (10K)	B	25.6/50.6
R10	7030005220	S.RES ERJ2GEJ 223 X (22K)	B	22.2/48.1
R11	7030005050	S.RES ERJ2GEJ 103 X (10K)	B	31.5/40.5
R12	7030004980	S.RES ERJ2GEJ 101 X (10K)	B	39.2/39.5
R13	7030005050	S.RES ERJ2GEJ 103 X (10K)	B	32.5/40.5
R14	7030005050	S.RES ERJ2GEJ 103 X (10K)	B	32.5/38.8
R15	7030005700	S.RES ERJ2GEJ 274 X (270K)	B	39.2/38.6
R16	7030004980	S.RES ERJ2GEJ 101 X (10K)	B	39.5/40.7
R17	7030005530	S.RES ERJ2GEJ 100 X (10)	B	51.5/40.2
R18	7030005050	S.RES ERJ2GEJ 103 X (10K)	B	60.8/40.5
R19	7030005090	S.RES ERJ2GEJ 104 X (100K)	B	39.2/36.8
R20	7030005120	S.RES ERJ2GEJ 102 X (1K)	B	52.8/38.6
R21	7030005050	S.RES ERJ2GEJ 103 X (10K)	B	54.1/40.2
R22	7030005050	S.RES ERJ2GEJ 103 X (10K)	B	56.2/37.4
R23	7030005050	S.RES ERJ2GEJ 103 X (10K)	B	54.1/41.2
R29	7030005570	S.RES ERJ2GEJ 820 X (82)	B	71.0/40.6
R30	7030007300	S.RES ERJ2GEJ 332 X (3.3K)	B	71.3/41.2
R31	7030004980	S.RES ERJ2GEJ 101 X (10K)	B	66.9/37.4
R33	7030005600	S.RES ERJ2GEJ 273 X (27K)	T	71.9/42.7
R34	7030005110	S.RES ERJ2GEJ 224 X (220K)	T	64.9/23.1
R35	7030005530	S.RES ERJ2GEJ 100 X (10)	T	64.9/22.2
R36	7030007290	S.RES ERJ2GEJ 222 X (2.2K)	B	56.2/21.7
R37	7030008410	S.RES ERJ2GEJ 392 X (3.9K)	B	56.6/25.5
R38	7030005090	S.RES ERJ2GEJ 104 X (100K)	T	61.7/17.8
R39	7030004970	S.RES ERJ2GEJ 470 X (47)	B	58.4/22.2
R40	7030005030	S.RES ERJ2GEJ 152 X (1.5K)	B	58.4/23.2
R41	7030010040	S.RES ERJ2GEJ-JPW	T	60.8/17.8
R42	7030005070	S.RES ERJ2GEJ 683 X (68K)	T	51.0/24.3
R43	7030005000	S.RES ERJ2GEJ 471 X (470)	T	55.6/19.9
R44	7030005100	S.RES ERJ2GEJ 154 X (150K)	T	54.0/24.7
R45	7030005080	S.RES ERJ2GEJ 823 X (82K)	T	52.2/24.7
R46	7030008410	S.RES ERJ2GEJ 392 X (3.9K)	T	54.0/22.9
R48	7030008300	S.RES ERJ2GEJ 184 X (180K)	T	56.8/53.2
R49	7520000241	S.POS PRF18BC471QB5RB	T	47.3/53.2
R50	7030005050	S.RES ERJ2GEJ 103 X (10K)	B	80.1/37.9
R51	7030005080	S.RES ERJ2GEJ 823 X (82K)	T	61.8/49.8
R52	7030005070	S.RES ERJ2GEJ 683 X (68K)	T	58.7/52.1
R53	7030004990	S.RES ERJ2GEJ 221 X (220)	T	57.8/53.2
R54	7030005220	S.RES ERJ2GEJ 223 X (22K)	B	58.8/55.7
R56	7030005110	S.RES ERJ2GEJ 224 X (220K)	T	63.3/55.0
R57	7030005050	S.RES ERJ2GEJ 103 X (10K)	B	58.8/54.8
R58	7030005070	S.RES ERJ2GEJ 820 X (82)	T	64.2/55.0
R59	7030007350	S.RES ERJ2GEJ 393 X (39K)	T	59.7/52.1
R61	7030004970	S.RES ERJ2GEJ 470 X (47)	B	90.5/49.5
R62	7030008290	S.RES ERJ2GEJ 183 X (18K)	B	89.6/49.5
R66	7030005090	S.RES ERJ2GEJ 104 X (100K)	B	84.9/49.1
R67	7030004980	S.RES ERJ2GEJ 101 X (10K)	B	83.0/47.3
R68	7030005050	S.RES ERJ2GEJ 103 X (10K)	B	82.6/48.7
R69	7030005040	S.RES ERJ2GEJ 472 X (4.7K)	B	84.0/38.0
R70	7030004990	S.RES ERJ2GEJ 221 X (220)	B	92.8/35.8
R71	7030007260	S.RES ERJ2GEJ 330 X (33)	B	95.3/33.8
R72	7030004980	S.RES ERJ2GEJ 101 X (10K)	B	86.5/49.1
R73	7030004980	S.RES ERJ2GEJ 101 X (10K)	B	99.5/35.3
R74	7030005080	S.RES ERJ2GEJ 823 X (82K)	B	101.3/33.7
R75	7030005720	S.RES ERJ2GEJ 563 X (56K)	B	97.6/32.2
R76	7030005030	S.RES ERJ2GEJ 152 X (1.5K)	B	96.7/32.2
R77	7030005120	S.RES ERJ2GEJ 102 X (1K)	T	106.6/36.1
R78	7030009270	S.RES ERJ2GEJ 821 X (820)	T	102.5/32.5
R79	7030006020	S.RES RR0510P-682-D (6.8K)	B	96.5/23.7
R80	7030005120	S.RES ERJ2GEJ 102 X (1K)	T	100.0/32.5
R83	7030006020	S.RES RR0510P-682-D (6.8K)	B	106.4/29.1
R84	7030006020	S.RES RR0510P-682-D (6.8K)	B	106.4/28.2
R85	7030006020	S.RES RR0510P-682-D (6.8K)	B	95.6/25.3
R86	7030005110	S.RES ERJ2GEJ 224 X (220K)	B	102.6/24.4
R87	7030005530	S.RES ERJ2GEJ 100 X (10)	B	102.6/27.5
R89	7030005050	S.RES ERJ2GEJ 103 X (10K)	T	79.0/25.0
R90	7030005170	S.RES ERJ2GEJ 474 X (470K)	T	95.9/15.3
R92	7030005100	S.RES ERJ2GEJ 154 X (150K)	T	94.3/14.4
R93	7030005600	S.RES ERJ2GEJ 273 X (27K)	T	81.3/25.8
R95	7030005710	S.RES ERJ2GEJ 121 X (120)	B	83.8/24.5
R96	7030008400	S.RES ERJ2GEJ 182 X (1.8K)	B	83.8/23.5
R97	7030010040	S.RES ERJ2GEJ-JPW	B	82.2/24.5
R98	7030007290	S.RES ERJ2GEJ 222 X (2.2K)	T	109.5/33.8
R100	7030005240	S.RES ERJ2GEJ 473 X (47K)	T	76.1/20.3
R101	7030004980	S.RES ERJ2GEJ 101 X (10K)	T	77.9/22.2
R123	7030005530	S.RES ERJ2GEJ 100 X (10)	T	68.2/40.4
R125	7030008370	S.RES ERJ2GEJ 561 X (560)	T	65.6/29.2
R171	7030004980	S.RES ERJ2GEJ 101 X (10K)	T	45.5/28.6
R172	7030008300	S.RES ERJ2GEJ 184 X (180K)	T	44.2/27.1
R173	7030005120	S.RES ERJ2GEJ 102 X (1K)	T	42.9/26.4
R174	7030005290	S.RES ERJ2GEJ 682 X (6.8K)	T	42.0/28.8
R175	7030009290	S.RES ERJ2GEJ 562 X (5.6K)	T	41.6/27.6
R176	7030005030	S.RES ERJ2GEJ 152 X (1.5K)	T	42.0/26.4
R178	7030004970	S.RES ERJ2GEJ 470 X (47)	B	38.4/26.7
R211	7030004970	S.RES ERJ2GEJ 470 X (47)	T	82.7/28.3
R212	7030010040	S.RES ERJ2GEJ-JPW	T	82.6/60.4
R234	7030005070	S.RES ERJ2GEJ 683 X (68K)	B	92.8/34.9
R235	7030004980	S.RES ERJ2GEJ 101 X (10K)	B	81.0/37.9
R236	7030007570	S.RES ERJ2GEJ 122 X (1.2K)	B	67.4/22.7
R237	7030007060	S.RES ERJ2GEJ 684X (680K)	B	67.4/23.6
R289	7030005060	S.RES ERJ2GEJ 333 X (33K)	T	95.9/12.6
R290	7030007280	S.RES ERJ2GEJ 331 X (330)	T	63.2/23.1
R291	7030005090	S.RES ERJ2GEJ 104 X (100K)	T	94.3/13.5
R293	7030006610	S.RES ERJ2GEJ 394 X (390K)	T	88.4/12.0
R295	7030006610	S.RES ERJ2GEJ 394 X (390K)	T	101.0/17.3
R299	7030008300	S.RES ERJ2GEJ 184 X (180K)	B	74.6/38.5
R300	7030005720	S.RES ERJ2GEJ 563 X (56K)	B	76.8/40.6
R301	7030005100	S.RES ERJ2GEJ 154 X (150K)	B	67.5/40.5
R302	7030005720	S.RES ERJ2GEJ 563 X (56K)	B	66.9/38.3
R308	7030009140	S.RES ERJ2GEJ 272 X (2.7K)	T	56.9/54.9
R311	7030010040	S.RES ERJ2GEJ-JPW	B	94.9/32.2
R317	7030005120	S.RES ERJ2GEJ 102 X (1K)	T	103.8/36.5
R319	7030005210	S.RES ERJ2GEJ 822 X (8.2K)	T	37.3/37.9
R320	7030005170	S.RES ERJ2GEJ 474 X (470K)	T	35.5/36.2
R328	7030010040	S.RES ERJ2GEJ-JPW	B	104.8/29.1
R334	7030007280	S.RES ERJ2GEJ 331 X (330)	T	87.6/61.3
R337	7030005300	S.RES ERJ2GEJ 150 X (15)	T	87.1/62.7
R338	7030007280	S.RES ERJ2GEJ 331 X (330)	T	87.6/64.1
R339	7030010040	S.RES ERJ2GEJ-JPW	B	96.5/25.3
R340	7030005050	S.RES ERJ2GEJ 103 X (10K)	B	72.4/25.3
R350	7030005600	S.RES ERJ2GEJ 273 X (27K)	B	52.9/26.2
R351	7030005600	S.RES ERJ2GEJ 273 X (27K)	B	43.2/26.2
R352	7030007300	S.RES ERJ2GEJ 332 X (3.3K)	B	50.9/26.8
R353	7030005210	S.RES ERJ2GEJ 822 X (8.2K)	B	45.4/27.1
R354	7030005210	S.RES ERJ2GEJ 822 X (8.2K)	B	46.5/29.0
R355	7030005000	S.RES ERJ2GEJ 471 X (470)	B	44.4/29.4
R394	7030010040	S.RES ERJ2GEJ-JPW	B	100.1/27.3
R395	7030010040	S.RES ERJ2GEJ-JPW	B	26.7/46.8
R478	7030007340	S.RES ERJ2GEJ 153 X (15K)	B	34.1/28.5
R479	7030005600	S.RES ERJ2GEJ 273 X (27K)	T	66.8/27.4
R483	7030007300	S.RES ERJ2GEJ 332 X (3.3K)	T	71.5/28.8
R484	7030007300	S.RES ERJ2GEJ 332 X (3.3K)	T	76.5/42.5
R485	7030010040	S.RES ERJ2GEJ-JPW	T	77.0/4

[MAIN-F UNIT] (For [350 MHz band] versions)

REF NO.	PARTS NO.	DESCRIPTION	M.	H/V LOCATION
R621	7410001130	S.ARR EXB28V102JX	B	76.6/19.6
R622	7030007570	S.RES ERJ2GEJ 122 X (1.2K)	B	83.8/21.6
R623	7030005090	S.RES ERJ2GEJ 104 X (100K)	T	50.7/26.1
R624	7030005090	S.RES ERJ2GEJ 104 X (100K)	T	83.2/11.6
R625	7030010040	S.RES ERJ2GEJ-JPW	B	96.1/20.1
R1003	7030007601	S.RES ERA3YKD 913V (91K)	B	72.6/9.4
R1004	7030006101	S.RES ERA3YED 183V (18K)	B	70.2/10.2
R1005	7030005120	S.RES ERJ2GEJ 102 X (1K)	T	112.3/16.5
R1006	7030005090	S.RES ERJ2GEJ 104 X (100K)	B	112.4/4.8
R1008	7030010040	S.RES ERJ2GEJ-JPW	T	124.9/24.8
R1009	7030005050	S.RES ERJ2GEJ 103 X (10K)	T	133.3/49.2
R1010	7030005050	S.RES ERJ2GEJ 103 X (10K)	T	128.6/23.8
R1012	7030005040	S.RES ERJ2GEJ 472 X (4.7K)	T	110.6/46.0
R1013	7030005240	S.RES ERJ2GEJ 473 X (4.7K)	T	114.7/49.0
R1014	7030005090	S.RES ERJ2GEJ 104 X (100K)	T	98.3/12.1
R1015	7030005120	S.RES ERJ2GEJ 102 X (1K)	B	115.3/22.8
R1016	7030005090	S.RES ERJ2GEJ 104 X (100K)	B	115.6/6.1
R1018	7030005090	S.RES ERJ2GEJ 104 X (100K)	T	111.7/7.0
R1020	7030005090	S.RES ERJ2GEJ 104 X (100K)	B	114.7/24.9
R1021	7030005120	S.RES ERJ2GEJ 102 X (1K)	B	116.5/6.1
R1022	7030005120	S.RES ERJ2GEJ 102 X (1K)	T	114.9/7.1
R1023	7030005050	S.RES ERJ2GEJ 103 X (10K)	B	125.2/15.7
R1024	7030007290	S.RES ERJ2GEJ 222 X (2.2K)	B	131.6/17.6
R1025	7030000480	S.RES MCR10EZHJ 6.8K (682)	B	129.4/47.0
R1026	7030000480	S.RES MCR10EZHJ 6.8K (682)	B	129.4/48.8
R1027	7030010040	S.RES ERJ2GEJ-JPW	T	113.7/16.5
R1028	7030004970	S.RES ERJ2GEJ 470 X (47)	B	114.9/13.4
R1029	7030005120	S.RES ERJ2GEJ 102 X (1K)	T	115.3/10.5
R1030	7030005050	S.RES ERJ2GEJ 103 X (10K)	T	114.4/10.5
R1031	7030005050	S.RES ERJ2GEJ 103 X (10K)	B	117.8/7.7
R1032	7030005120	S.RES ERJ2GEJ 102 X (1K)	B	127.1/19.9
R1033	7030000480	S.RES MCR10EZHJ 6.8K (682)	B	129.4/45.2
R1034	7030005040	S.RES ERJ2GEJ 472 X (4.7K)	B	123.6/17.5
R1035	7030005050	S.RES ERJ2GEJ 103 X (10K)	T	107.8/42.5
R1036	7030005040	S.RES ERJ2GEJ 472 X (4.7K)	T	107.8/41.2
R1037	7030005090	S.RES ERJ2GEJ 104 X (100K)	T	95.9/13.5
R1038	7030005120	S.RES ERJ2GEJ 102 X (1K)	B	125.6/36.3
R1039	7030005090	S.RES ERJ2GEJ 104 X (100K)	B	113.7/12.9
R1040	7030005160	S.RES ERJ2GEJ 105 X (1M)	T	111.2/12.9
R1043	7030005160	S.RES ERJ2GEJ 105 X (1M)	B	112.0/11.0
R1044	7030005090	S.RES ERJ2GEJ 104 X (100K)	B	117.9/9.9
R1045	7030005050	S.RES ERJ2GEJ 103 X (10K)	B	120.4/17.1
R1046	7030005800	S.RES RR0510P-104-D (1K)	B	119.7/9.0
R1047	7030005050	S.RES ERJ2GEJ 103 X (10K)	B	119.4/18.6
R1048	7030009710	S.RES ERJ2GEJ 203 X (20K)	B	119.0/22.4
R1049	7030005040	S.RES ERJ2GEJ 472 X (4.7K)	B	116.7/19.7
R1050	7030007290	S.RES ERJ2GEJ 222 X (2.2K)	B	123.1/39.7
R1054	7030008270	S.RES RR0510P-104-D (100K)	B	119.7/9.9
R1055	7030005090	S.RES ERJ2GEJ 104 X (100K)	B	120.4/15.2
R1056	7030008270	S.RES RR0510P-104-D (100K)	B	118.8/10.8
R1057	7030005100	S.RES ERJ2GEJ 154 X (150K)	B	118.8/15.2
R1059	7410001130	S.ARR EXB28V102JX	T	69.7/14.8
R1060	7410001130	S.ARR EXB28V102JX	T	63.4/14.8
R1062	7030008270	S.RES RR0510P-104-D (100K)	B	116.0/14.8
R1068	7030005120	S.RES ERJ2GEJ 102 X (1K)	T	74.3/14.1
R1069	7030005120	S.RES ERJ2GEJ 102 X (1K)	T	72.6/14.1
R1070	7030005120	S.RES ERJ2GEJ 102 X (1K)	T	57.3/15.1
R1082	7410001130	S.ARR EXB28V102JX	T	56.9/6.7
R1083	7030005120	S.RES ERJ2GEJ 102 X (1K)	B	69.1/8.8
R1084	7410001130	S.ARR EXB28V102JX	T	61.7/6.1
R1085	7030005120	S.RES ERJ2GEJ 102 X (1K)	T	65.7/7.1
R1098	7510001730	S.THE ERTJJOEP 473J	T	74.9/15.5
R1099	7030008270	S.RES RR0510P-104-D (100K)	T	72.5/15.5
R1100	7410001130	S.ARR EXB28V102JX	T	75.3/6.0
R1105	7030003860	S.RES ERJ3GE JPW V	T	127.8/48.9
R1108	7030005240	S.RES ERJ2GEJ 473 X (4.7K)	B	124.9/47.2
R1114	7030005120	S.RES ERJ2GEJ 102 X (1K)	T	65.6/7.1
R1115	7030005120	S.RES ERJ2GEJ 102 X (1K)	T	65.7/5.3
R1116	7030007300	S.RES ERJ2GEJ 332 X (3.3K)	T	73.7/15.0
R1119	7030003860	S.RES ERJ3GE JPW V	T	99.5/68.6
R1500	7030005310	S.RES ERJ2GEJ 124 X (120K)	T	34.0/14.3
R1501	7030005240	S.RES ERJ2GEJ 473 X (4.7K)	T	37.1/19.2
R1502	7030009290	S.RES ERJ2GEJ 562 X (5.6K)	T	38.0/19.2
R1503	7030008010	S.RES ERJ2GEJ 123 X (12K)	T	34.0/15.2
R1504	7030008300	S.RES ERJ2GEJ 184 X (180K)	T	31.8/16.8
R1505	7030007340	S.RES ERJ2GEJ 153 X (15K)	T	34.0/18.1
R1506	7030007340	S.RES ERJ2GEJ 153 X (15K)	T	34.0/17.2
R1507	7030005050	S.RES ERJ2GEJ 103 X (10K)	T	34.2/19.3
R1508	7030005220	S.RES ERJ2GEJ 223 X (22K)	T	30.8/17.3
R1509	7030005050	S.RES ERJ2GEJ 103 X (10K)	T	30.8/18.9
R1510	7030006610	S.RES ERJ2GEJ 394 X (390K)	T	33.3/19.3
R1515	7030008010	S.RES ERJ2GEJ 123 X (12K)	T	38.4/23.6
R1517	7030010040	S.RES ERJ2GEJ-JPW	T	35.3/19.6
R1518	7030005310	S.RES ERJ2GEJ 124 X (120K)	T	37.6/21.7
R1519	7030007350	S.RES ERJ2GEJ 393 X (39K)	T	36.2/21.2
R1521	7030010040	S.RES ERJ2GEJ-JPW	B	39.7/23.2
R1523	7030005080	S.RES ERJ2GEJ 823 X (82K)	T	42.6/17.7
R1524	7030005030	S.RES ERJ2GEJ 152 X (1.5K)	T	42.6/18.6
R1525	7030010040	S.RES ERJ2GEJ-JPW	T	42.6/19.5
R1526	7030005070	S.RES ERJ2GEJ 683 X (68K)	T	41.4/18.1
R1527	7030005090	S.RES ERJ2GEJ 104 X (100K)	B	32.9/11.9
R1529	7030005070	S.RES ERJ2GEJ 683 X (68K)	T	44.4/20.4
R1530	7030005040	S.RES ERJ2GEJ 472 X (4.7K)	B	31.6/19.6
R1532	7030010040	S.RES ERJ2GEJ-JPW	T	55.7/15.7
R1534	7030009140	S.RES ERJ2GEJ 272 X (2.7K)	B	37.2/24.6
R1535	7030005090	S.RES ERJ2GEJ 104 X (100K)	B	38.2/24.6
R1536	7030005060	S.RES ERJ2GEJ 333 X (33K)	T	32.4/10.3
R1537	7030005240	S.RES ERJ2GEJ 473 X (4.7K)	T	32.4/11.8
R1538	7030007350	S.RES ERJ2GEJ 393 X (39K)	B	123.5/35.6
R1539	7030005220	S.RES ERJ2GEJ 223 X (22K)	B	125.6/38.1
R2003	7030007250	S.RES ERJ2GEJ 220 X (22K)	B	16.7/6.8
R2004	7030005210	S.RES ERJ2GEJ 822 X (8.2K)	B	12.6/8.8
R2005	7030005210	S.RES ERJ2GEJ 822 X (8.2K)	B	15.8/6.8
R2013	7030005240	S.RES ERJ2GEJ 473 X (4.7K)	B	19.8/12.0
R2016	7030010040	S.RES ERJ2GEJ-JPW	B	24.0/5.8

Eqv.= This component is equivalent to the REF No. component listed above, and may be substituted on parts orders and repairs.

[MAIN-F UNIT] (For [350 MHz band] versions)

REF NO.	PARTS NO.	DESCRIPTION	M.	H/V LOCATION
R2019	70300010040	S.RES ERJ2GEJ-JPW	B	9.9/17.9
R2020	70300010040	S.RES ERJ2GEJ-JPW	B	14.4/11.1
R2021	7030004980	S.RES ERJ2GEJ 101 X (100)	B	23.6/12.1
R2022	7030004980	S.RES ERJ2GEJ 101 X (100)	B	27.9/24.7
R2024	7030005240	S.RES ERJ2GEJ 473 X (4.7K)	B	26.6/21.6
R2026	7030004970	S.RES ERJ2GEJ 470 X (47)	B	27.9/22.9
R2028	7030005240	S.RES ERJ2GEJ 473 X (4.7K)	B	12.1/19.3
R2030	7030005240	S.RES ERJ2GEJ 473 X (4.7K)	B	11.0/21.2
R2031	7030005240	S.RES ERJ2GEJ 473 X (4.7K)	B	10.7/29.4
R2032	7030005240	S.RES ERJ2GEJ 473 X (4.7K)	B	24.9/17.4
R2034	7030005240	S.RES ERJ2GEJ 473 X (4.7K)	B	28.8/10.5
R2035	7030005240	S.RES ERJ2GEJ 473 X (4.7K)	B	26.7/14.9
R2036	7030004980	S.RES ERJ2GEJ 101 X (100)	T	26.8/11.9
R2037	7030007290	S.RES ERJ2GEJ 222 X (2.2K)	T	28.1/10.7
R2038	7030004970	S.RES ERJ2GEJ 470 X (47)	B	28.8/12.1
R2039	7030005240	S.RES ERJ2GEJ 473 X (4.7K)	B	24.1/9.5
R2040	7030005240	S.RES ERJ2GEJ 473 X (4.7K)	B	24.5/12.1
R2043	7410001140	S.ARR EXB28V104JX	T	15.6/26.7
R2044	7410001140	S.ARR EXB28V104JX	B	20.8/26.3
R2045	7410001140	S.ARR EXB28V104JX	T	27.0/22.6
R2046	7410001140	S.ARR EXB28V104JX	T	19.3/26.7
R2047	7410001140	S.ARR EXB28V104JX	B	10.9/14.5
R2048	7030005090	S.RES ERJ2GEJ 104 X (100K)	T	25.7/14.7
R2049	7030005090	S.RES ERJ2GEJ 104 X (100K)	B	21.8/15.6
R2050	7410001140	S.ARR EXB28V104JX	B	22.6/18.2
R2051	7410001140	S.ARR EXB28V104JX	T	9.9/17.6
R2052	7030005090	S.RES ERJ2GEJ 104 X (100K)	T	16.8/11.6
R2053	7030005090	S.RES ERJ2GEJ 104 X (100K)	B	16.0/14.5
R2056	70300010040	S.RES ERJ2GEJ-JPW	T	10.6/20.0
R2057	7030005090	S.RES ERJ2GEJ 104 X (100K)	T	10.4/22.9
R2058	7410001140	S.ARR EXB28V104JX	B	17.0/18.6
R2059	7030005090	S.RES ERJ2GEJ 104 X (100K)	T	10.4/23.8
R2060	7030005090	S.RES ERJ2GEJ 104 X (100K)	T	25.7/15.2
R2061	7030005090	S.RES ERJ2GEJ 104 X (100K)	B	14.7/12.6
R2062	7030005090	S.RES ERJ2GEJ 104 X (100K)	B	17.7/14.4
R2063	7030005090	S.RES ERJ2GEJ 104 X (100K)	B	22.1/23.4
R2064	7030005090	S.RES ERJ2GEJ 104 X (100K)	B	19.7/17.7
R2065	7030005030	S.RES ERJ2GEJ 152 X (1.5K)	B	13.8/6.8
R2076	7030010040	S.RES ERJ2GEJ-JPW	T	28.4/18.8
R2077	7030010040	S.RES ERJ2GEJ-JPW	T	28.7/16.4
R2086	7030004970	S.RES ERJ2GEJ 470 X (47)	T	17.3/3.7
R2087	7030004970	S.RES ERJ2GEJ 470 X (47)	T	18.9/7.0
R2088	7030004990	S.RES ERJ2GEJ 221 X (220)	T	19.9/7.0
R2089	7030004970	S.RES ERJ2GEJ 470 X (47)	T	21.9/7.0
R2090	7030010040	S.RES ERJ2GEJ-JPW	B	8.7/9.0
C1	4030011080	S.CER GRM31M2C2H6R0DV01L (GRM42-6 CH)	B	8.4/66.6
C2	4030011080	S.CER GRM31M2C2H6R0DV01L (GRM42-6 CH)	B	7.4/58.6
C3	4030009500	S.CER C1608 CH 1H 0R5B-T	B	25.6/51.9
C4	4030009500	S.CER C1608 CH 1H 0R5B-T	B	16.4/51.9
C5	4030009500	S.CER C1608 CH 1H 0R5B-T	B	8.2/54.5
C6	4030011100	S.CER GRM31M2C2H8R0DV01L (GRM42-6 CH)	B	7.4/56.3
C7	4030011110	S.CER GRM31M2C2H9R0DV01L (GRM42-6 CH)	B	13.1/60.7
C8	4030011100	S.CER GRM31M2C2H8R0DV01L (GRM42-6 CH)	B	19.5/60.7
C9	4030011100	S.CER GRM31M2C2H8R0DV01L (GRM42-6 CH)	T	30.6/53.1
C10	4030017730	S.CER C1005 JB 1H 471K-T	B	18.1/48.1
C11	4030017730	S.CER C1005 JB 1H 471K-T	B	10.0/49.2
C12	4030017730	S.CER C1005 JB 1H 471K-T	T	39.4/54.4
C13	4030017420	S.CER C1005 CH 1H 470J-T	B	49.5/51.4
C14	4030019420	S.CER GRM31A7U2J102JW31D	B	34.9/55.5
C15	4030017360	S.CER C1005 CH 1H 030B-T	T	23.7/50.4
C20	4030017670	S.CER C1005 CH 1H 390J-T	B	30.6/40.5
C21	4030017580	S.CER C1005 CH 1H 060C-T	B	26.7/38.1
C22	4030017560	S.CER C1005 CH 1H 2R5B-T	B	32.0/37.5
C25	4030017420	S.CER C1005 CH 1H 470J-T	B	25.8/38.1
C26	4030017670	S.CER C1005 CH 1H 390J-T	B	33.4/40.5
C27	4030016930	S.CER C1005 JB 1A 104K-T	B	31.5/38.8
C28	4030017460	S.CER C1005 JB 1H 102K-T	B	32.5/36.2
C29	4030017600	S.CER C1005 CH 1H 080C-T	B	37.1/37.4
C30	4030017630	S.CER C1005 CH 1H 120J-T	B	39.2/37.7
C31	4030016930	S.CER C1005 JB 1A 104K-T	B	51.5/37.4
C32	4030017460	S.CER C1005 JB 1H 102K-T	B	41.3/40.7
C33	4030017420	S.CER C1005 CH 1H 470J-T	B	38.6/40.7
C34	403001746			

[MAIN-F UNIT] (For [350 MHz band] versions)

REF NO.	PARTS NO.	DESCRIPTION	M.	H/V LOCATION
C64	4030016790	S.CER C1005 JB 1E 103K-T	B	56.2/26.8
C65	4030016790	S.CER C1005 JB 1E 103K-T	T	58.2/19.6
C66	4030017460	S.CER C1005 JB 1H 102K-T	T	54.7/19.9
C67	4030017460	S.CER C1005 JB 1H 102K-T	B	58.4/21.3
C68	4030017680	S.CER C1005 CH 1H 820J-T	T	52.2/23.8
C69	4030017710	S.CER C1005 CH 1H 181J-T	T	54.0/23.8
C70	4030017430	S.CER C1005 CH 1H 101J-T	T	54.0/25.6
C71	4030016930	S.CER C1005 JB 1A 104K-T	T	57.4/29.0
C72	4030017730	S.CER C1005 JB 1H 471K-T	T	59.8/48.0
C74	4030017730	S.CER C1005 JB 1H 471K-T	B	11.2/50.5
C75	4030019560	S.CER GRM21BB31C106KE15L	T	61.6/25.3
C76	4030016790	S.CER C1005 JB 1E 103K-T	T	57.8/54.9
C77	4030017460	S.CER C1005 JB 1H 102K-T	T	56.8/50.7
C78	4030017730	S.CER C1005 JB 1H 471K-T	B	58.8/56.6
C79	4030016960	S.CER C1005 JB 1E 183K-T	T	62.4/55.0
C81	4030017460	S.CER C1005 JB 1H 102K-T	T	65.1/55.0
C82	4030011030	S.CER GRM31M4C2H1R5CY21L (GRM42-6 CK)	T	34.9/65.2
C84	4030017420	S.CER C1005 CH 1H 470J-T	T	55.0/61.6
C85	4030017460	S.CER C1005 JB 1H 102K-T	T	56.0/61.6
C86	4030017710	S.CER C1005 CH 1H 181J-T	T	81.3/63.8
C87	4030017460	S.CER C1005 JB 1H 102K-T	T	79.8/68.8
C88	4030017730	S.CER C1005 JB 1H 471K-T	T	64.6/52.1
C89	4030017600	S.CER C1005 CH 1H 080C-T	B	87.3/57.5
C90	4030017600	S.CER C1005 CH 1H 080C-T	B	88.2/57.5
C92	4030017570	S.CER C1005 CH 1H 040B-T	B	89.9/58.0
C93	4030017630	S.CER C1005 CH 1H 120J-T	B	86.9/51.5
C96	4030017460	S.CER C1005 JB 1H 102K-T	B	87.8/56.3
C97	4030017730	S.CER C1005 JB 1H 471K-T	B	87.8/55.4
C98	4030017380	S.CER C1005 CH 1H 050B-T	B	83.5/48.7
C99	4030017730	S.CER C1005 JB 1H 471K-T	B	81.4/48.3
C100	4030017600	S.CER C1005 CH 1H 080C-T	B	91.2/34.9
C102	4030017580	S.CER C1005 CH 1H 060C-T	B	97.1/33.8
C103	4030017360	S.CER C1005 CH 1H 030B-T	B	98.5/32.2
C104	4030017460	S.CER C1005 JB 1H 102K-T	B	100.8/29.9
C105	4030017730	S.CER C1005 JB 1H 471K-T	B	97.6/28.9
C106	4030017420	S.CER C1005 CH 1H 470J-T	B	91.7/48.9
C107	4030017460	S.CER C1005 JB 1H 102K-T	T	80.2/51.7
C108	4030016790	S.CER C1005 JB 1E 103K-T	B	81.3/49.2
C109	4030017460	S.CER C1005 JB 1H 102K-T	B	95.8/35.3
C110	4030017730	S.CER C1005 JB 1H 471K-T	B	98.6/35.3
C112	4030016930	S.CER C1005 JB 1A 104K-T	T	100.8/37.1
C113	4030017520	S.CER C1005 CH 1H 0R3B-T	B	102.0/29.6
C114	4030017610	S.CER C1005 CH 1H 090C-T	B	98.3/26.1
C115	4030017400	S.CER C1005 CH 1H 220J-T	B	98.8/21.9
C116	4030017460	S.CER C1005 JB 1H 102K-T	B	107.5/30.0
C117	4030017730	S.CER C1005 JB 1H 471K-T	B	107.5/30.9
C118	4030017520	S.CER C1005 CH 1H 0R3B-T	B	102.8/32.0
C119	4030016790	S.CER C1005 JB 1E 103K-T	B	97.0/21.9
C120	4030017730	S.CER C1005 JB 1H 471K-T	B	97.9/21.9
C121	4030017590	S.CER C1005 CH 1H 070C-T	B	103.3/30.8
C122	4030017390	S.CER C1005 CH 1H 180J-T	B	107.5/31.8
C123	4030017670	S.CER C1005 CH 1H 390J-T	B	104.8/28.2
C124	4030017660	S.CER C1005 CH 1H 330J-T	B	105.0/20.8
C125	4030017420	S.CER C1005 CH 1H 470J-T	B	101.7/27.5
C126	4030018070	S.CER C1005 CH 1H 300J-T	B	95.6/23.7
C127	4030017660	S.CER C1005 CH 1H 330J-T	B	96.1/21.9
C128	4030017360	S.CER C1005 CH 1H 030B-T	B	99.2/27.3
C129	4030017530	S.CER C1005 CH 1H 0R5B-T	B	103.5/27.5
C131	4030017600	S.CER C1005 CH 1H 080C-T	B	106.4/27.2
C132	4030017460	S.CER C1005 JB 1H 102K-T	T	94.3/12.6
C133	4030017640	S.CER C1005 CH 1H 150J-T	B	105.4/22.7
C134	4030017390	S.CER C1005 CH 1H 180J-T	B	93.7/22.8
C135	4030016790	S.CER C1005 JB 1E 103K-T	T	78.3/21.0
C136	4030017370	S.CER C1005 CH 1H 3R5B-T	B	95.2/20.1
C139	4030016930	S.CER C1005 JB 1A 104K-T	B	107.5/33.6
C140	4030017430	S.CER C1005 CH 1H 101J-T	B	81.2/18.9
C141	4030017460	S.CER C1005 JB 1H 102K-T	T	75.7/21.5
C143	4030017460	S.CER C1005 JB 1H 102K-T	T	78.9/22.2
C144	4030017420	S.CER C1005 CH 1H 470J-T	T	92.5/16.1
C146	4550000530	S.TAN TEESVA 1V 104M8R	T	84.7/22.9
Eqv.	4550008210	S.TAN 267M3502 104MR		
C147	4550003250	S.TAN TEESVA 1V 474M8R	T	80.5/22.9
Eqv.	4550007590	S.TAN F931V474MAABMA		
C148	4030019560	S.CER GRM21BB31C106KE15L	T	109.7/30.5
C151	4030016930	S.CER C1005 JB 1A 104K-T	B	75.3/18.1
C152	4030017420	S.CER C1005 CH 1H 470J-T	B	77.8/18.1
C153	4030017420	S.CER C1005 CH 1H 470J-T	B	78.1/16.2
C154	4030017420	S.CER C1005 CH 1H 470J-T	B	76.4/16.2
C155	4030017460	S.CER C1005 JB 1H 102K-T	B	81.7/16.7
C156	4030016790	S.CER C1005 JB 1E 103K-T	B	81.2/17.9
C157	4030017620	S.CER C1005 CH 1H 100C-T	B	72.4/24.4
C160	4030016930	S.CER C1005 JB 1A 104K-T	B	74.3/21.3
C162	4030016790	S.CER C1005 JB 1E 103K-T	B	72.4/17.7
C165	4030017460	S.CER C1005 JB 1H 102K-T	B	74.1/23.5
C191	4030017580	S.CER C1005 CH 1H 060C-T	B	29.7/40.5
C192	4030017580	S.CER C1005 CH 1H 060C-T	B	34.3/40.5
C193	4030017570	S.CER C1005 CH 1H 040B-T	B	51.5/38.3
C277	4030016930	S.CER C1005 JB 1A 104K-T	B	33.9/30.7
C281	4030017770	S.CER C1005 JB 1H 332K-T	T	92.0/13.5
C282	4030016930	S.CER C1005 JB 1A 104K-T	T	44.2/28.0
C283	4030016930	S.CER C1005 JB 1A 104K-T	T	45.2/25.2
C284	4030016930	S.CER C1005 JB 1A 104K-T	T	44.2/28.9
C285	4030017580	S.CER C1005 CH 1H 060C-T	B	94.0/29.9
C286	4030017600	S.CER C1005 CH 1H 080C-T	B	35.1/28.5
C287	4030018140	S.CER C1005 JB 1H 391K-T	T	95.9/11.7
C298	4030017620	S.CER C1005 CH 1H 100C-T	T	86.3/29.4
C299	4030017580	S.CER C1005 CH 1H 060C-T	T	83.9/29.4
C300	4030017560	S.CER C1005 CH 1H 2R5B-T	T	85.1/30.8
C301	4030017730	S.CER C1005 JB 1H 471K-T	B	92.8/31.3
C302	4030017420	S.CER C1005 CH 1H 470J-T	B	80.1/39.2
C303	4030017730	S.CER C1005 JB 1H 471K-T	B	80.1/36.3
C305	4030017500	S.CER C1005 CH 1H 560J-T	B	64.8/24.2
C306	4030017580	S.CER C1005 CH 1H 060C-T	B	64.3/25.4
C307	4030017500	S.CER C1005 CH 1H 560J-T	B	61.3/22.7

Eqv.= This component is equivalent to the REF No. component listed above, and may be substituted on parts orders and repairs.

[MAIN-F UNIT] (For [350 MHz band] versions)

REF NO.	PARTS NO.	DESCRIPTION	M.	H/V LOCATION
C308	4030017360	S.CER C1005 CH 1H 030B-T	B	60.1/23.2
C309	4030016790	S.CER C1005 JB 1E 103K-T	B	67.4/21.8
C312	4030016930	S.CER C1005 JB 1A 104K-T	B	67.4/20.9
C314	4030016790	S.CER C1005 JB 1E 103K-T	T	110.5/33.8
C323	4030017620	S.CER C1005 CH 1H 100C-T	B	72.3/26.2
C328	4030017340	S.CER C1005 CH 1H 010B-T	B	85.4/55.8
C332	4030017530	S.CER C1005 CH 1H 0R5B-T	B	84.9/50.0
C333	4030017420	S.CER C1005 CH 1H 470J-T	B	40.4/40.7
C334	4030017590	S.CER C1005 CH 1H 070C-T	B	94.9/68.3
C335	4030017630	S.CER C1005 CH 1H 120J-T	B	93.8/68.3
C336	4030017710	S.CER C1005 CH 1H 181J-T	B	62.0/68.7
C337	4030017460	S.CER C1005 JB 1H 102K-T	T	82.7/29.2
C340	4030017710	S.CER C1005 CH 1H 181J-T	B	107.7/28.7
C342	4550002980	S.TAN TEESVA 1C 225M8R	T	78.4/66.1
Eqv.	4550007390	S.TAN F831C225MAABMA		
C343	4030017460	S.CER C1005 JB 1H 102K-T	B	51.5/39.2
C344	4030017460	S.CER C1005 JB 1H 102K-T	B	54.2/68.0
C345	4030017730	S.CER C1005 JB 1H 471K-T	B	54.2/67.1
C346	4030017420	S.CER C1005 CH 1H 470J-T	B	66.0/68.7
C347	4030017460	S.CER C1005 JB 1H 102K-T	T	52.2/22.9
C348	4030017460	S.CER C1005 JB 1H 102K-T	T	59.3/20.5
C350	4030017920	S.CER C1005 JB 1A 883K-T	T	95.9/14.4
C357	4030016930	S.CER C1005 JB 1A 104K-T	T	105.1/36.1
C358	4030017340	S.CER C1005 CH 1H 010B-T	B	91.2/35.8
C366	4030017460	S.CER C1005 JB 1H 102K-T	B	97.0/64.4
C367	4030017730	S.CER C1005 JB 1H 471K-T	B	97.0/65.8
C368	4030017420	S.CER C1005 CH 1H 470J-T	B	97.0/67.3
C372	4030017730	S.CER C1005 JB 1H 471K-T	T	60.3/67.7
C376	4030017730	S.CER C1005 JB 1H 471K-T	B	88.7/49.5
C377	4030017460	S.CER C1005 JB 1H 102K-T	T	57.8/61.6
C383	4030016930	S.CER C1005 JB 1A 104K-T	T	36.4/36.2
C384	4030016930	S.CER C1005 JB 1A 104K-T	T	59.3/29.0
C385	4030016930	S.CER C1005 JB 1A 104K-T	B	54.9/28.9
C388	4030017730	S.CER C1005 JB 1H 471K-T	B	68.2/36.7
C390	4030017460	S.CER C1005 JB 1H 102K-T	B	75.0/40.6
C391	4030017420	S.CER C1005 CH 1H 470J-T	B	75.9/40.6
C392	4030017540	S.CER C1005 CH 1H R75B-T	B	60.3/39.2
C393	4030017570	S.CER C1005 CH 1H 040B-T	B	66.3/40.6
C394	4030016930	S.CER C1005 JB 1A 104K-T	B	50.9/28.8
C395	4030016930	S.CER C1005 JB 1A 104K-T	B	45.6/29.0
C396	4030016930	S.CER C1005 JB 1A 104K-T	T	55.8/29.0
C397	4030016790	S.CER C1005 JB 1E 103K-T	B	55.9/13.2
C398	4030016790	S.CER C1005 JB 1E 103K-T	B	48.6/27.3
C399	4030016790	S.CER C1005 JB 1E 103K-T	B	48.3/28.5
C400	4030017710	S.CER C1005 CH 1H 181J-T	T	81.2/37.6
C401	4030017580	S.CER C1005 CH 1H 060C-T	B	78.6/40.6
C402	4030011070	S.CER GRM31M2C2H5R0CY21L (GRM42-6 CH)	B	38.0/68.7
C403	4030011070	S.CER GRM31M2C2H5R0CY21L (GRM42-6 CH)	B	34.9/65.2
C404	4030011110	S.CER GRM31M2C2H9R0DV01L (GRM42-6 CH)	B	15.5/60.7
C408	4030017730	S.CER C1005 JB 1H 471K-T	B	23.9/48.1
C409	4030017460	S.CER C1005 JB 1H 102K-T	B	39.3/51.1
C411	4030017460	S.CER C1005 JB 1H 102K-T	T	42.2/55.4
C413	4030018860	S.CER C1005 JB 0J 105K-T	B	91.5/25.3
C416	4030017420	S.CER C1005 CH 1H 470J-T	B	93.4/25.3
C418	4030018890	S.CER C1005 JB 0J 224K-T	T	102.8/17.3
C420	4030011110	S.CER GRM31M2C2H9R0DV01L (GRM42-6 CH)	B	21.7/60.7
C421	4030011080	S.CER GRM31M2C2H6R0DV01L (GRM42-6 CH)	B	28.2/60.7
C423	4030017570	S.CER C1005 CH 1H 040B-T	B	77.7/40.6
C429	4030017640	S.CER C1005 CH 1H 150J-T	B	61.9/42.0
C447	4030017730	S.CER C1005 JB 1H 471K-T	B	83.3/52.0
C448	4030017670	S.CER C1005 CH 1H 390J-T	B	87.8/49.5
C453	4030017420	S.CER C1005 CH 1H 470J-T	B	101.3/35.3
C454	4030017460	S.CER C1005 JB 1H 102K-T	B	100.4/35.3
C457	4030017420	S.CER C1005 CH 1H 470J-T	B	54.0/37.4
C458	4030017420	S.CER C1005 CH 1H 470J-T	T	63.8/50.8
C459	4030017420	S.CER C1005 CH 1H 470J-T	T	86.1/48.4
C460	4030017420	S.CER C1005 CH 1H 470J-T	T	64.9/49.8
C463	4030018820	S.CER C1005 JB 1H 561K-T	T	54.0/26.5
C466	4030017420	S.CER C1005 CH 1H 470J-T	T	62.7/49.8
C467	4030017420	S.CER C1005 CH 1H 470J-T	T	88.4/1

[MAIN-F UNIT] (For [350 MHz band] versions)

REF NO.	PARTS NO.	DESCRIPTION	M.	H/V LOCATION
C1017	4030017460	S.CER C1005 JB 1H 102K-T	B	122.5/64.9
C1018	4030017460	S.CER C1005 JB 1H 102K-T	B	133.3/45.0
C1019	4510009250	S.ELE EEEFK1C471P	T	130.5/34.8
C1022	4030017420	S.CER C1005 CH 1H 470J-T	B	105.5/59.0
C1023	4030017460	S.CER C1005 JB 1H 102K-T	B	113.4/58.8
C1024	4030017440	S.CER C1005 CH 1H 221J-T	B	113.4/59.7
C1025	4030017510	S.CER C1005 CH 1H 680J-T	B	113.4/60.6
C1026	4030019120	S.CER GRM188B31E105KA75D	T	115.8/49.5
C1028	4030017460	S.CER C1005 JB 1H 102K-T	B	117.4/6.1
C1029	4030017460	S.CER C1005 JB 1H 102K-T	T	114.9/12.6
C1031	4030017460	S.CER C1005 JB 1H 102K-T	T	115.0/16.9
C1032	4030016930	S.CER C1005 JB 1A 104K-T	B	123.6/16.6
C1033	4510009680	S.ELE EEEFK1E471P	B	120.0/29.1
C1034	4030018860	S.CER C1005 JB 0J 105K-T	B	131.6/16.6
C1035	4030016790	S.CER C1005 JB 1E 103K-T	B	131.6/18.7
C1036	4030018980	S.CER C1608 JB 1H 104K-T	T	128.4/46.9
C1037	4030019560	S.CER GRM21BB31C106KE15L	B	129.4/43.4
C1038	4030011600	S.CER C1608 JB 1E 104K-T	T	110.5/48.7
C1039	4510009680	S.ELE EEEFK1E471P	B	117.0/41.7
C1040	4030019560	S.CER GRM21BB31C106KE15L	B	116.7/22.2
C1042	4030016930	S.CER C1005 JB 1A 104K-T	B	118.1/22.4
C1043	4030016930	S.CER C1005 JB 1A 104K-T	T	114.9/16.0
C1045	4030017460	S.CER C1005 JB 1H 102K-T	T	114.9/14.2
C1046	4030018860	S.CER C1005 JB 0J 105K-T	T	114.9/15.1
C1048	4030018900	S.CER C1005 JB 0J 474K-T	B	126.7/18.6
C1050	4030018860	S.CER C1005 JB 0J 105K-T	B	125.2/16.6
C1051	4030017460	S.CER C1005 JB 1H 102K-T	B	122.1/48.2
C1052	4030016930	S.CER C1005 JB 1A 104K-T	T	127.8/40.1
C1053	4030019560	S.CER GRM21BB31C106KE15L	T	127.8/44.5
C1056	4030018860	S.CER C1005 JB 0J 105K-T	T	111.2/11.7
C1057	4030016930	S.CER C1005 JB 1A 104K-T	B	118.7/17.1
C1058	4030019560	S.CER GRM21BB31C106KE15L	T	105.5/44.4
C1059	4030017460	S.CER C1005 JB 1H 102K-T	T	107.7/46.3
C1060	4030017460	S.CER C1005 JB 1H 102K-T	B	126.4/39.8
C1061	4030017460	S.CER C1005 JB 1H 102K-T	T	107.7/37.4
C1062	4030017460	S.CER C1005 JB 1H 102K-T	B	120.7/22.9
C1063	4030019560	S.CER GRM21BB31C106KE15L	B	126.9/32.2
C1064	4030019560	S.CER GRM21BB31C106KE15L	B	121.6/36.0
C1065	4030017460	S.CER C1005 JB 1H 102K-T	B	120.2/35.6
C1066	4030018860	S.CER C1005 JB 0J 105K-T	B	124.9/39.7
C1070	4030017440	S.CER C1005 CH 1H 221J-T	B	120.4/16.2
C1071	4030016930	S.CER C1005 JB 1A 104K-T	B	120.4/10.8
C1074	4030017460	S.CER C1005 JB 1H 102K-T	B	73.9/10.4
C1075	4030017460	S.CER C1005 JB 1H 102K-T	B	70.7/14.4
C1076	4030017460	S.CER C1005 JB 1H 102K-T	B	69.7/14.4
C1077	4030017460	S.CER C1005 JB 1H 102K-T	B	68.8/14.4
C1081	4030016930	S.CER C1005 JB 1A 104K-T	B	117.2/15.2
C1082	4030016930	S.CER C1005 JB 1A 104K-T	B	114.8/14.6
C1092	4030016930	S.CER C1005 JB 1A 104K-T	B	75.8/14.4
C1098	4030018860	S.CER C1005 JB 0J 105K-T	T	53.4/16.3
C1100	4030017460	S.CER C1005 JB 1H 102K-T	B	75.8/9.1
C1101	4030016930	S.CER C1005 JB 1A 104K-T	T	78.2/8.0
C1102	4030017420	S.CER C1005 CH 1H 470J-T	B	71.6/6.6
C1119	4030017420	S.CER C1005 CH 1H 470J-T	B	65.2/6.9
C1133	4030016790	S.CER C1005 JB 1E 103K-T	T	78.2/5.7
C1135	4030017460	S.CER C1005 JB 1H 102K-T	T	73.9/16.8
C1136	4030016930	S.CER C1005 JB 1A 104K-T	T	71.6/15.5
C1142	4030016930	S.CER C1005 JB 1A 104K-T	B	117.6/11.8
C1143	4030018980	S.CER C1608 JB 1H 104K-T	B	93.8/9.4
C1500	4030016930	S.CER C1005 JB 1A 104K-T	T	35.6/14.3
C1501	4030018860	S.CER C1005 JB 0J 105K-T	T	34.0/16.3
C1502	4030019990	S.CER C1005 JB 1C 104K-T	T	35.2/15.7
C1503	4030018090	S.CER C1005 JB 1E 822K-T	T	32.7/16.8
C1504	4030017430	S.CER C1005 CH 1H 101J-T	T	32.3/18.0
C1505	4030018860	S.CER C1005 JB 0J 105K-T	B	30.6/17.2
C1506	4030020120	S.CER C1005 JB 0J 225M-T	T	32.4/19.3
C1507	4030018860	S.CER C1005 JB 0J 105K-T	B	31.9/18.0
C1511	4030016790	S.CER C1005 JB 1E 103K-T	B	35.0/23.3
C1512	4030018860	S.CER C1005 JB 0J 105K-T	B	36.3/24.3
C1515	4030018860	S.CER C1005 JB 0J 105K-T	T	36.2/19.6
C1516	4030017710	S.CER C1005 CH 1H 181J-T	T	37.6/20.7
C1517	4030018860	S.CER C1005 JB 0J 105K-T	B	37.9/23.0
C1518	4030016930	S.CER C1005 JB 1A 104K-T	B	38.8/23.0
C1519	4030020000	S.CER C1005 JB 1A 105K-T	B	42.7/22.2
C1520	4030020000	S.CER C1005 JB 1A 105K-T	B	41.8/22.2
C1521	4030020000	S.CER C1005 JB 1A 105K-T	B	40.9/22.1
C1522	4030020000	S.CER C1005 JB 1A 105K-T	B	42.8/20.3
C1523	4030017900	S.CER C1005 JB 1E 123K-T	T	42.6/20.4
C1524	4030016930	S.CER C1005 JB 1A 104K-T	B	44.0/20.5
C1525	4030017460	S.CER C1005 JB 1H 102K-T	B	44.9/20.5
C1526	4030017460	S.CER C1005 JB 1H 102K-T	T	40.2/16.1
C1527	4030016930	S.CER C1005 JB 1A 104K-T	T	41.1/16.1
C1528	4030016930	S.CER C1005 JB 1A 104K-T	T	37.6/13.0
C1529	4030017460	S.CER C1005 JB 1H 102K-T	T	39.1/12.2
C1530	4030017920	S.CER C1005 JB 1A 683K-T	T	33.1/13.1
C1532	4030020020	S.CER C1005 CH 1H 391J-T	T	43.8/18.1
C2001	4050000240	S.FEE NFM18PC104R1C3D	T	39.4/8.8
C2002	4030016930	S.CER C1005 JB 1A 104K-T	B	35.1/5.3
C2004	4550007730	S.TAN TEESVJ 0J 106M8R	B	35.5/7.0
Eqv.	4550008380	S.TAN TMCJ0J106MTRF		
C2007	4030018910	S.CER C1608 JB 0J 475K-T	B	18.4/10.4
C2008	4030016930	S.CER C1005 JB 1A 104K-T	B	16.1/8.9
C2009	4050000240	S.FEE NFM18PC104R1C3D	B	28.0/5.9
C2010	4050000240	S.FEE NFM18PC104R1C3D	B	12.3/5.5
C2011	4030019460	S.CER C1608 JB 0J 106M-T	T	33.0/6.9
C2012	4030016930	S.CER C1005 JB 1A 104K-T	B	26.4/5.8
C2013	4550007730	S.TAN TEESVJ 0J 106M8R	B	25.0/6.2
Eqv.	4550008380	S.TAN TMCJ0J106MTRF		
C2014	4030016930	S.CER C1005 JB 1A 104K-T	T	31.7/6.6
C2015	4030016930	S.CER C1005 JB 1A 104K-T	B	10.1/6.4
C2016	4550007720	S.TAN TEESVP 0G 476M8R	T	26.7/7.1
Eqv.	4550008410	TAN 251M4001 476MR12S		
C2017	4550007730	S.TAN TEESVJ 0J 106M8R	B	17.2/9.2
Eqv.	4550008380	S.TAN TMCJ0J106MTRF		
C2019	4030016790	S.CER C1005 JB 1E 103K-T	B	14.8/19.3

Eqv.= This component is equivalent to the REF No. component listed above, and may be substituted on parts orders and repairs.

[MAIN-F UNIT] (For [350 MHz band] versions)

REF NO.	PARTS NO.	DESCRIPTION	M.	H/V LOCATION
C2021	4030018910	S.CER C1608 JB 0J 475K-T	B	16.0/21.6
C2022	4030018910	S.CER C1608 JB 0J 475K-T	B	13.5/14.5
C2023	4030016790	S.CER C1005 JB 1E 103K-T	B	23.1/14.3
C2024	4030018860	S.CER C1005 JB 0J 105K-T	B	21.2/14.1
C2033	4030018860	S.CER C1005 JB 0J 105K-T	B	15.1/17.7
C2036	4030018860	S.CER C1005 JB 0J 105K-T	B	21.1/20.9
C2038	4030016790	S.CER C1005 JB 1E 103K-T	B	16.4/25.3
C2040	4030016790	S.CER C1005 JB 1E 103K-T	T	26.4/18.1
C2041	4030018910	S.CER C1608 JB 0J 475K-T	T	11.1/14.5
C2042	4030016930	S.CER C1005 JB 1A 104K-T	T	10.1/14.8
C2044	4030016790	S.CER C1005 JB 1E 103K-T	T	26.4/19.9
C2045	4030016930	S.CER C1005 JB 1A 104K-T	B	26.6/23.4
C2046	4030016930	S.CER C1005 JB 1A 104K-T	B	26.6/24.3
C2047	4030016930	S.CER C1005 JB 1A 104K-T	B	26.6/20.7
C2048	4030016930	S.CER C1005 JB 1A 104K-T	B	26.6/22.5
C2049	4030017420	S.CER C1005 CH 1H 470J-T	B	25.7/9.5
C2050	403001720	S.CER C1005 CH 1H 400C-T	B	26.7/15.8
C2051	4030016930	S.CER C1005 JB 1A 104K-T	B	13.6/29.4
C2052	4030016930	S.CER C1005 JB 1A 104K-T	B	25.5/15.3
C2053	4030017460	S.CER C1005 JB 1H 102K-T	B	27.4/10.4
C2054	4030016930	S.CER C1005 JB 1A 104K-T	T	25.5/12.4
C2055	4030017400	S.CER C1005 CH 1H 220J-T	B	11.0/20.3
C2056	4030017380	S.CER C1005 CH 1H 050B-T	T	27.2/10.7
C2057	4030016930	S.CER C1005 JB 1A 104K-T	B	24.1/10.4
C2058	4030016790	S.CER C1005 JB 1E 103K-T	B	28.8/13.7
C2062	4030018860	S.CER C1005 JB 0J 105K-T	T	9.4/20.1
C2063	4030017420	S.CER C1005 CH 1H 470J-T	T	2.1/14.7
C2064	4030017420	S.CER C1005 CH 1H 470J-T	T	2.5/13.0
C2065	4030017420	S.CER C1005 CH 1H 470J-T	T	3.8/13.5
C2066	4030017420	S.CER C1005 CH 1H 470J-T	T	6.5/16.5
C2067	4030017420	S.CER C1005 CH 1H 470J-T	T	7.5/24.0
C2069	4030017420	S.CER C1005 CH 1H 470J-T	T	27.5/17.2
C2070	4030016930	S.CER C1005 JB 1A 104K-T	B	21.0/12.5
C2071	4030016930	S.CER C1005 JB 1A 104K-T	B	21.7/19.7
C2072	4030016930	S.CER C1005 JB 1A 104K-T	B	17.2/23.8
C2073	4030016930	S.CER C1005 JB 1A 104K-T	B	20.2/16.0
C2076	4030016930	S.CER C1005 JB 1A 104K-T	T	7.7/27.1
C2077	4030019610	S.CER GRM155B31A105KE15D	B	41.2/6.1
C2078	4030017460	S.CER C1005 JB 1H 102K-T	B	39.8/9.0
C2079	4030017460	S.CER C1005 JB 1H 102K-T	B	38.2/9.0
C2080	4030016790	S.CER C1005 JB 1E 103K-T	B	36.7/5.3
C2081	4550007730	S.TAN TEESVJ 0J 106M8R	B	36.7/7.0
Eqv.	4550008380	S.TAN TMCJ0J106MTRF		
C2084	4030017420	S.CER C1005 CH 1H 470J-T	T	35.0/12.4
C2085	4030017420	S.CER C1005 CH 1H 470J-T	T	34.1/11.6
C2086	4030017420	S.CER C1005 CH 1H 470J-T	T	22.0/5.4
C2087	4030017420	S.CER C1005 CH 1H 470J-T	T	17.3/5.7
C2088	4030017420	S.CER C1005 CH 1H 470J-T	T	17.3/8.9
C2089	4030017420	S.CER C1005 CH 1H 470J-T	T	18.9/9.5
C2090	4030017420	S.CER C1005 CH 1H 470J-T	T	21.2/8.6
C2091	4030017420	S.CER C1005 CH 1H 470J-T	T	36.5/12.1
C2092	4030017460	S.CER C1005 JB 1H 102K-T	T	30.0/23.0
J1001	6510014961	S.CON B2B-ZR-SM4-TF(LF)(SN)	T	130.5/27.3
J1002	6450000140	CON HSJ0807-01-010		
J1003	6510022891	S.CON B13B-ZR-SM4-TF(LF)(SN)	T	120.0/17.2
J1004	6510027960	S.CON 04-6294-040-000-800	T	67.5/10.6
S1001	2260003180	S.SWI MINISMDC050F-2 CN <UDX>	T	114.1/33.8
W1	7030012290	JUM RDS2TOR0		
W2	8900011863	CAB OPC-1195C <TJM>		
EP1	6910018460	S.BEA MMZ1005Y102C-T	B	107.5/32.7
EP4	6910010280	BEA HF70BB9.5X10.4X4.9		
EP5	6910010280	BEA HF70BB9.5X10.4X4.9		
EP7	6910018460	S.BEA MMZ1005Y102C-T	B	74.2/19.7
EP8	6910018460	S.BEA MMZ1005Y102C-T	B	80.8/16.4
EP13	6910018460	S.BEA MMZ1005Y102C-T	B	100.1/25.3
EP1003	6910016330	S.BEA MMZ1005S 601CT-S	B	42.8/19.2
EP1004	6910016330	S.BEA MMZ1005S 601CT-S	B	42.7/15.8
EP1005	6910016330	S.BEA MMZ1005S 601CT-S	T	43.1/15.8
EP1006	6910018460	S.BEA MMZ1005Y102C-T	T	39.6/13.4
EP200				

BOARD LAYOUTS

The combination of top side and bottom side of this page shows the actual configuration of P.C. board.

• MAIN-D/MAIN-E/MAIN-F UNIT (TOP VIEW)

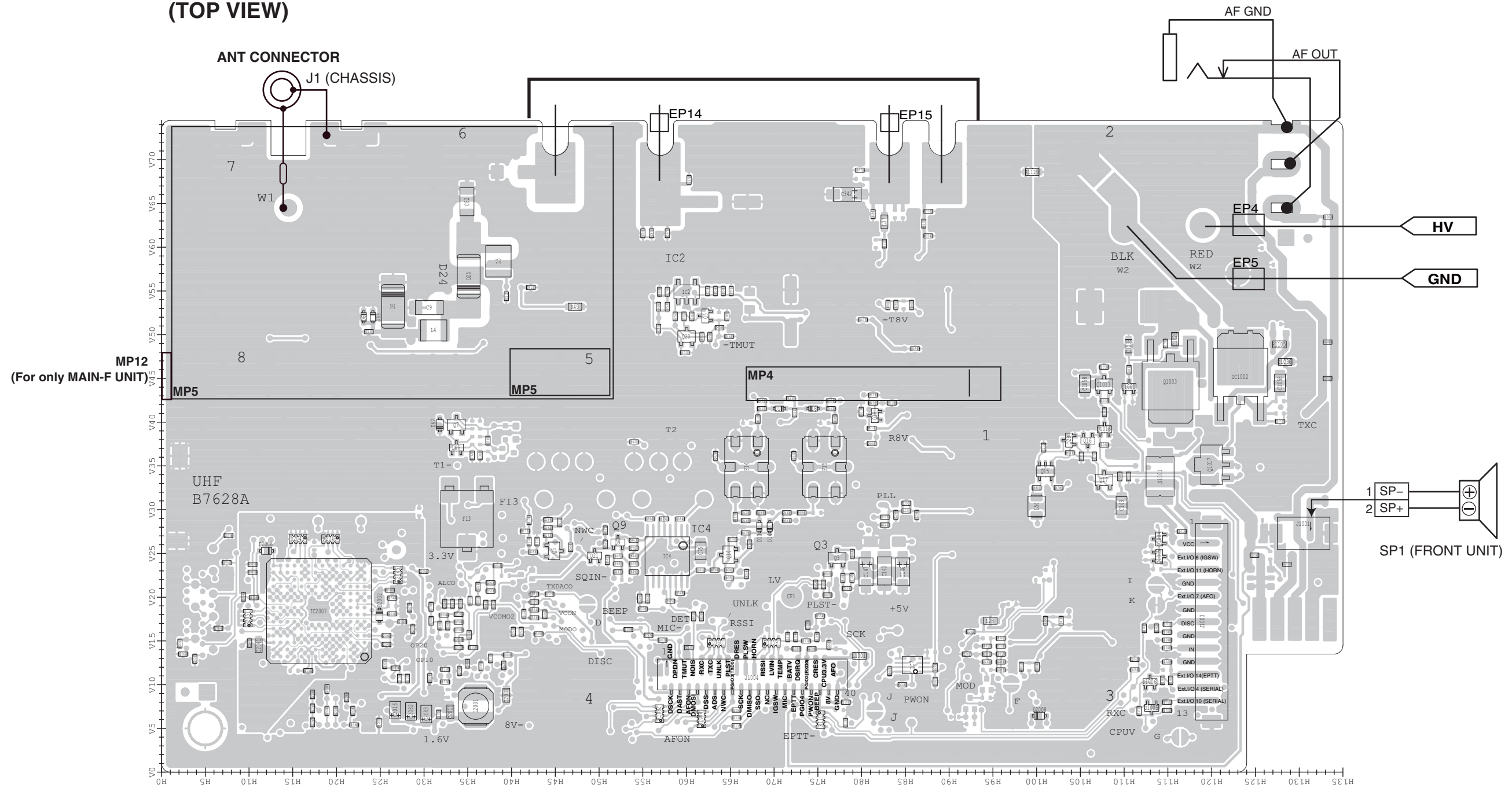

• MAIN-D/MAIN-E/MAIN-F UNIT
(BOTTOM VIEW)

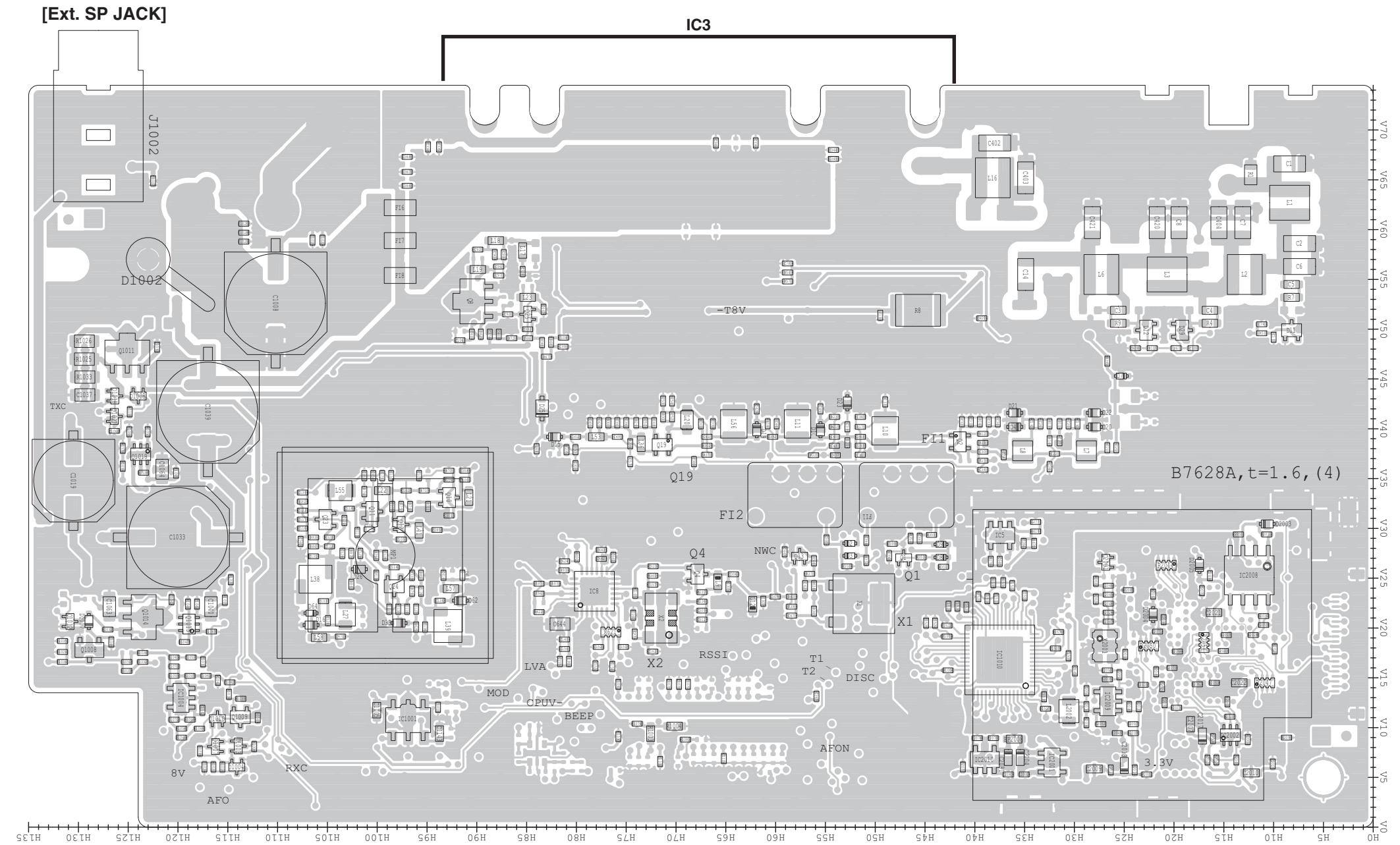

VOLTAGE DIAGRAM

• FRONT UNIT

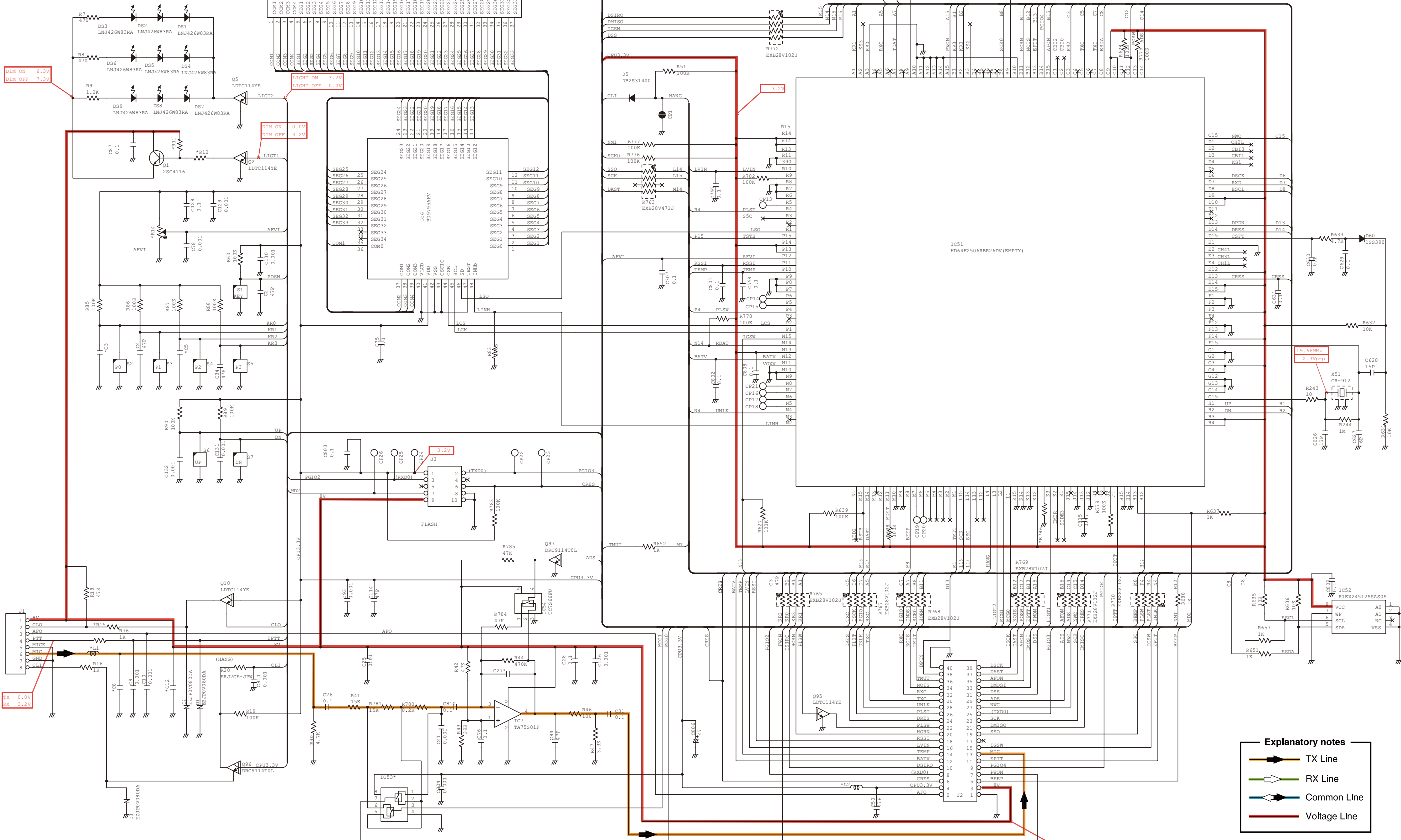

Explanatory notes

- TX Line
- RX Line
- Common Line
- Voltage Line

*: Refer to the PARTS LIST for the value and name of component.

• MAIN-D/MAIN-E/MAIN-F UNIT (1/3)

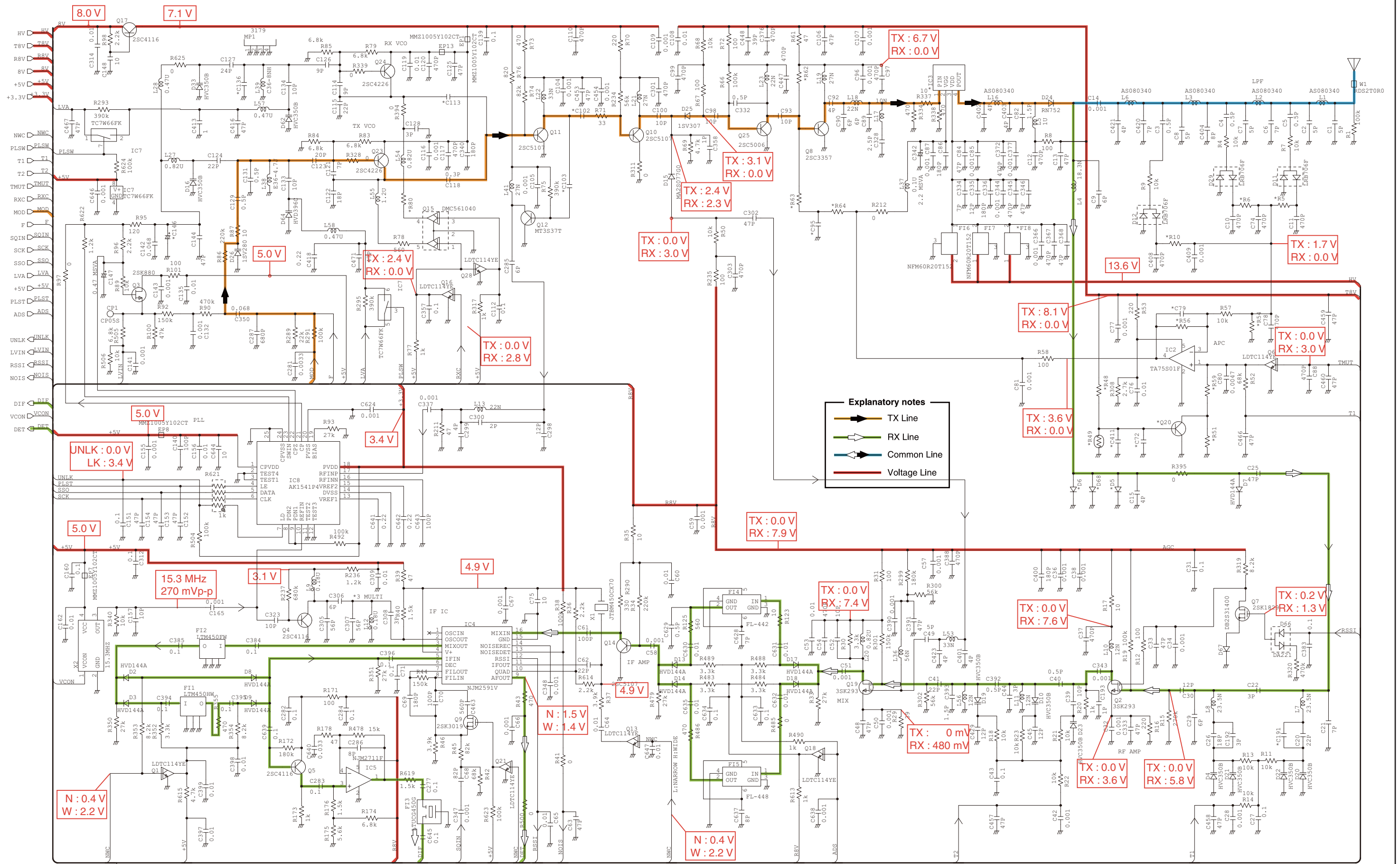

*: Refer to the PARTS LIST for the value and name of component.

• MAIN-D/MAIN-E/MAIN-F UNIT (2/3)

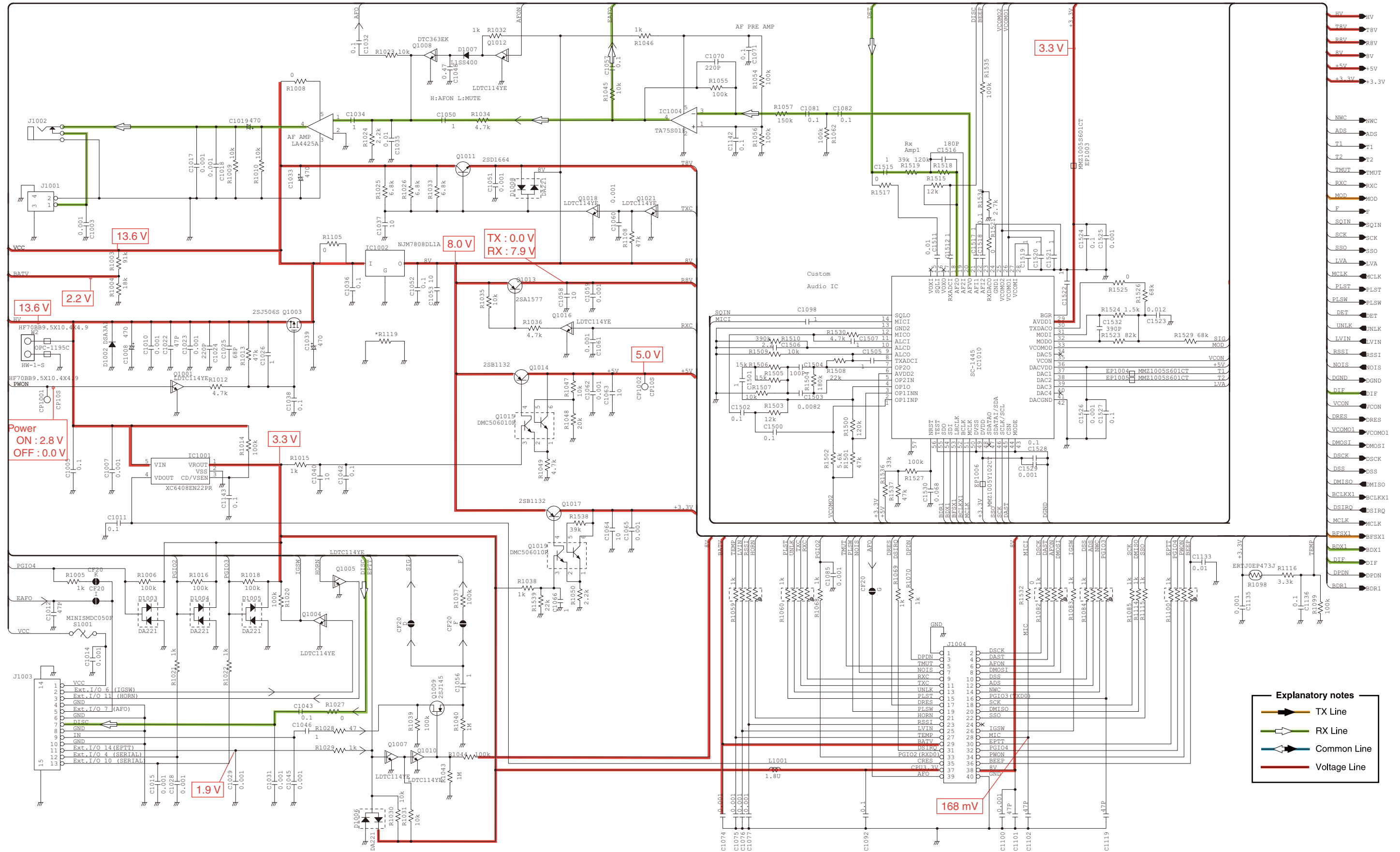

*: Refer to the PARTS LIST for the value and name of component.

• MAIN-D/MAIN-E/MAIN-F UNIT (3/3)

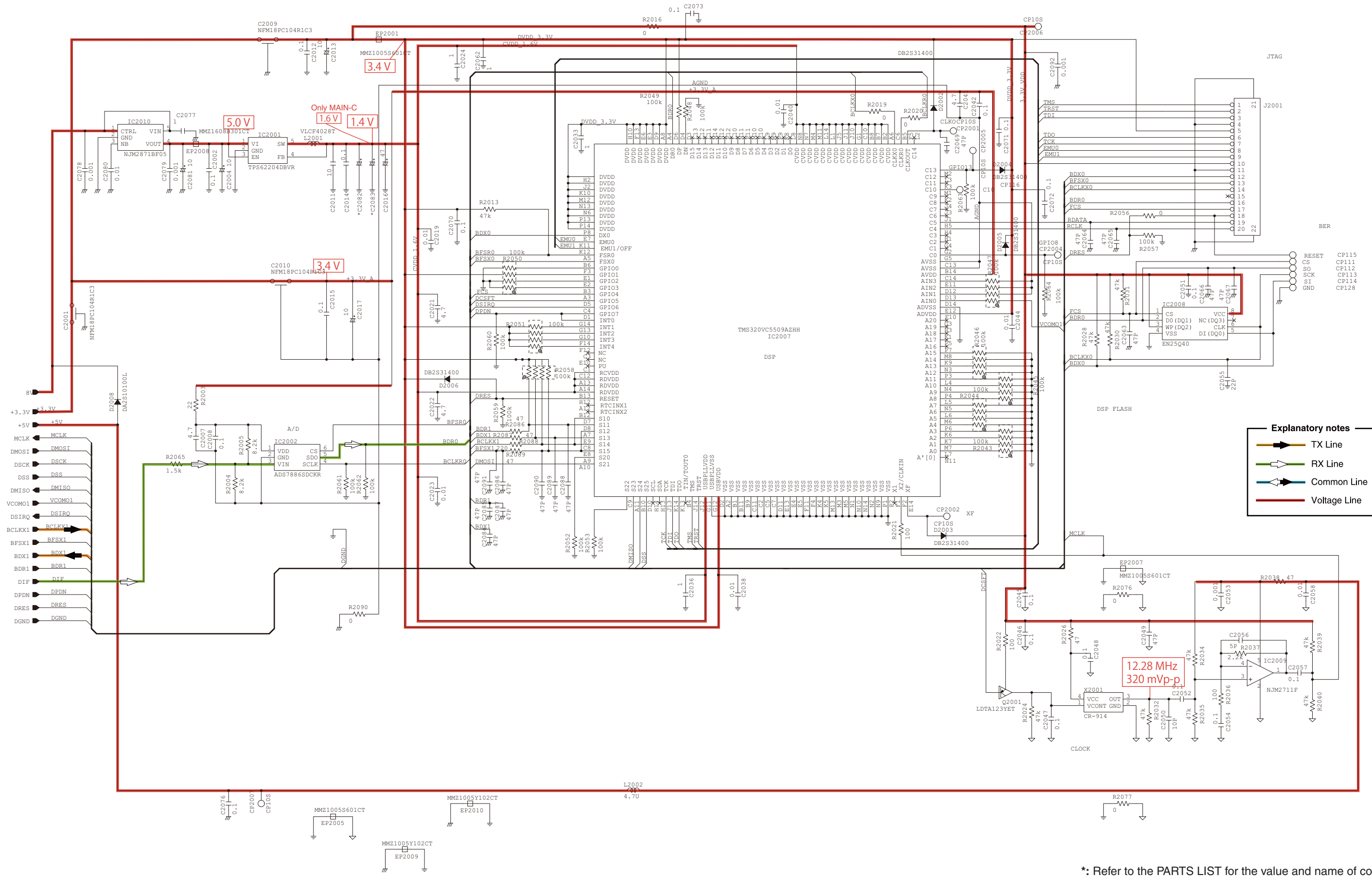

Explanatory notes

- TX Line
- RX Line
- Common Line
- Voltage Line

*: Refer to the PARTS LIST for the value and name of component.

IC-F6120D IC-F6122D IC-F6123D IC-F6128D

CONTENTS

REPLACEMENT PAGE	6-6
PARTS LIST	1
VOLTAGE DIAGRAM	17

[VERSION LIST]

MODEL	VERSION	FREQUENCY RANGE (MHz)	CHANNEL SPACING (kHz)	TX POWER
IC-F6121D	USA-01	400-470	6.25/12.5	45 W
	USA-02	450-512		
IC-F6122D	EUR-01	400-470	6.25/12.5/20.0/25.0	25 W
IC-F6123D	EXP-01		450-520	6.25/12.5/25.0
	EXP-03			
	EXP-04			
	EXP-06	350-400		
IC-F6128D	CHN-01	400-470		

6-3 TRANSMIT ADJUSTMENTS

1) Select an adjustment item using [↑]/[↓] on the PC's keyboard.

2) Set or modify the adjustment value as specified using [←]/[→] on the PC's keyboard, then push [ENTER].

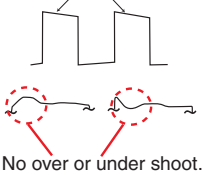
ADJUSTMENT	TRANSCEIVER'S CONDITION	OPERATION	ADJUSTMENT ITEM	VALUE	
TX OUTPUT POWER (Hi power)	1 • Channel : 1-3 • Transmitting	• Connect an RF power meter to the antenna connector.	[Power (Hi)]	45 W [45 W ver.] 25 W [25 W ver.]*	
(L2 power)	2 • Channel : 1-4 • Transmitting		[Power (L2)]	25 W [45 W ver.] 10 W [25 W ver.]*	
(L1 power)	3 • Channel : 1-5 • Transmitting		[Power (L1)]	4.5 W [45 W ver.] 2.5 W [25 W ver.]*	
MODULATION BALANCE -Band low-	1	• Set [MOD(NARROW)] to "150" on the "Adjust Utility" screen.	[MOD(NARROW)]	150	
	2	• Set [TX MODE] to "2 (Analog 100Hz Pulse)" on the "Adjust Utility" screen.	[TX MODE]	2 (Analog 100Hz Pulse)	
	3	• Push [ENTER] on the PC's keyboard, to enter the modulation balance adjustment mode.	[BAL Start]	–	
	4	• Channel : 1-6 • Transmitting	• Connect a modulation analyzer with an oscilloscope to the antenna connector, through an attenuator, and then set it as; HPF : OFF LPF : 20 kHz De-emphasis : OFF Detector : (P-P)/2	[BAL 1]	Square waveform As flat as possible. 
	-Band center-	5 • Channel : 1-7 • Transmitting		[BAL 2]	
	-Band high-	6 • Channel : 1-8 • Transmitting		[BAL 3]	
		7	• Push [ENTER] on the PC's keyboard, to store the value and quit the modulation balance adjustment mode.	[BAL Start]	–
FM DEVIATION (Narrow mode) -Band low-	1	• Push [ENTER] on the PC's keyboard, to enter the FM deviation (For narrow mode) adjustment mode.	[MOD N Start]	–	
	2	• Channel : 1-9 • Transmitting	• Connect a modulation analyzer to the antenna connector, through an attenuator, and set it as described in the "MODULATION BALANCE" above. • Connect as audio generator to the [MIC] jack, and set it as; Frequency : 1 kHz (Sine wave) Level : 40 mVrms	[MOD N L]	±2.05 to ±2.15 kHz
	-Band center-	3 • Channel : 1-10 • Transmitting		[MOD N C]	
	-Band high-	4 • Channel : 1-11 • Transmitting		[MOD N H]	
		5	• Push [ENTER] on the PC's keyboard, to store the value and quit the FM deviation (For narrow mode) adjustment mode.	[MOD N Start]	–
(Wide mode)† -Band low-	6	• Push [ENTER] on the PC's keyboard, to enter the FM deviation (For wide mode) adjustment mode.	[MOD W Start]	–	
	7	• Channel : 1-12 • Transmitting	• Connect a modulation analyzer to the antenna connector, through an attenuator, and set it as described in the "MODULATION BALANCE" above. • Connect as audio generator to the [MIC] jack, and set it as; Frequency : 1 kHz (Sine wave) Level : 40 mVrms	[MOD W L]	±4.05 to ±4.15 kHz (except [EUR-01]) ±4.15 to ±4.25 kHz ([EUR-01])
	-Band center-	8 • Channel : 1-13 • Transmitting		[MOD W C]	
	-Band high-	9 • Channel : 1-14 • Transmitting		[MOD W H]	
		10	• Push [ENTER] on the PC's keyboard, to store the value and quit the FM deviation (For wide mode) adjustment mode.	[MOD W Start]	–
(Middle mode)‡ -Band low-	11	• Push [ENTER] on the PC's keyboard, to enter the FM deviation (For middle mode) adjustment mode.	[MOD M Start]	–	
	12	• Channel : 1-15 • Transmitting	• Connect a modulation analyzer to the antenna connector, through an attenuator, and set it as described in the "MODULATION BALANCE" above. • Connect as audio generator to the [MIC] jack, and set it as; Frequency : 1 kHz (Sine wave) Level : 40 mVrms	[MOD M L]	±3.31 to ±3.41 kHz
	-Band center-	13 • Channel : 1-16 • Transmitting		[MOD M C]	
	-Band high-	14 • Channel : 1-17 • Transmitting		[MOD M H]	
		15	• Push [ENTER] on the PC's keyboard, to store the value and quit the FM deviation (For middle mode) adjustment mode.	[MOD M Start]	–

†; For all models except [USA] ‡; [EUR] only *; For only [Low band] versions.

PARTS LIST

[MAIN-A UNIT] (For [Low band] versions)

REF NO.	PARTS NO.	DESCRIPTION	M.	H/V LOCATION
IC2	1110002751	S.IC TA75S01F(TE85RF)	T	60/54.9
IC3	1150002380	IC RA30H4047M1-101 [EUR-01]		
	1150002380	IC RA30H4047M1-101 [EXP-01]		
	1150002400	IC RA60H4047M1-121 [USA-01]		
	1150002400	IC RA60H4047M1-121 [EXP-03]		
	1150002400	IC RA60H4047M1-121 [CHN-01]		
IC4	1110007320	S.IC NJM2591V-TE1-#ZZZB	T	57.8/24.7
IC5	1110006230	S.IC NJM2711F-TE1-#ZZZB	B	38.8/27.0
IC6	1110002751	S.IC TA75S01F(TE85RF)	B	43.0/21.2
IC7	1130011741	S.IC TC7W66FK(TE85LF)	B	28.3/24.7
IC8	1130015271	S.IC AK1541P4-L	B	78.2/23.7
IC1001	1180003660	S.REG X6408EN22PR-G	B	96.9/10.8
IC1002	1180003500	S.REG NJM7808DL1A-TE1-#FZZB	T	123.3/45.7
IC1004	1110002751	S.IC TA75S01F(TE85RF)	B	119.7/13.0
IC1005	1110007630	S.IC NJM2783V-TE1-#ZZZH	T	47.4/18.9
IC1006	1110007290	S.IC AK2330P-L	B	53.7/11.5
IC1007	1110005320	S.IC NJM13403V-TE1-#ZZZB	B	37.4/17.0
IC1008	1130009981	S.IC TC7W53FK(TE85LF)	T	40.3/19.7
IC1009	1110003091	S.IC LA4425A-E		
IC2001	1180003680	S.REG TPS62204DBVR	B	32.4/6.5
IC2002	1190002900	S.IC ADS7886SDCKR	B	14.4/9.3
IC2006	1110007770	S.IC PCM3008T2K	T	16.3/8.3
IC2007	1140013290	S.IC TMS320VC5509AZHH	T	18.0/18.4
IC2008	1130015620	S.IC EN25Q40-100GIP <MSK>	B	12.5/25.3
IC2009	1110006230	S.IC NJM2711F-TE1-#ZZZB	B	26.7/12.7
IC2010	1180003600	S.REG NJM2871BF05-TE1-#ZZZB	B	39.0/6.8
Q1	1590004090	S.TRA LDTC114YET1G <SLVJ>	B	47.2/27.1
Q2	1580000731	S.FET 3SK293(TE85LF)	B	41.5/38.7
Q3	1560000541	S.FET 2SK880-Y(T5RICOMF)	T	77.2/24.5
Q4	1530002851	S.TRA 2SC4116-BL(TE85RF)	B	67.9/25.4
Q5	1530002851	S.TRA 2SC4116-BL(TE85RF)	T	44.9/25.3
Q6	1590004090	S.TRA LDTC114YET1G <SLVJ>	T	62.2/52.2
Q7	1560000841	S.FET 2SK1829(TE85RF)	T	33.7/39.7
Q8	1530002680	S.TRA 2SC3357-T1	B	90.4/52.8
Q9	1560001360	S.FET 2SK3019 TL	T	52.2/26.3
Q10	1530003311	S.TRA 2SC5107-O(TE85RF)	B	92.8/33.1
Q11	1530003311	S.TRA 2SC5107-O(TE85RF)	B	100.5/31.7
Q12	1530004110	S.TRA MT3S37T(TE85LF)	B	97.6/30.4
Q13	1590004090	S.TRA LDTC114YET1G <SLVJ>	B	57.6/27.2
Q14	1530003311	S.TRA 2SC5107-O(TE85RF)	T	64.8/24.9
Q15	1590004500	S.TRA DMC561040R	T	101.0/34.4
Q17	1530002851	S.TRA 2SC4116-BL(TE85RF)	T	107.7/33.4
Q18	1590004090	S.TRA LDTC114YET1G <SLVJ>	T	81.5/40.8
Q19	1580000731	S.FET 3SK293(TE85LF)	B	71.4/38.4
Q20	1530002851	S.TRA 2SC4116-BL(TE85RF) [USA-01]	T	60.0/49.8
	1530002851	S.TRA 2SC4116-BL(TE85RF) [EXP-03]		
	1530002851	S.TRA 2SC4116-BL(TE85RF) [CHN-01]		
Q21	1590004090	S.TRA LDTC114YET1G <SLVJ>	T	49.5/24.8
Q23	1530002921	S.TRA 2SC4226-T1 Y25 (R25)	B	105.2/30.9
Q24	1530002921	S.TRA 2SC4226-T1 Y25 (R25)	B	98.3/24.2
Q25	1530003260	S.TRA 2SC5006-T1	B	84.9/51.5
Q1001	1590004090	S.TRA LDTC114YET1G <SLVJ>	T	110.6/44.1
Q1003	1550000190	S.FET 2SJ506STR-E	T	113.3/45.4
Q1004	1590004090	S.TRA LDTC114YET1G <SLVJ>	T	114.0/26.7
Q1005	1590004090	S.TRA LDTC114YET1G <SLVJ>	T	114.0/24.7
Q1007	1590004090	S.TRA LDTC114YET1G <SLVJ>	B	116.3/8.1
Q1008	1590000990	S.TRA DTC363EK T146	B	128.9/17.8
Q1009	1590001451	S.FET 2SJ144-GR (TE85RF)	B	113.8/11.1
Q1010	1590004090	S.TRA LDTC114YET1G <SLVJ>	B	116.1/10.9
Q1011	1540000550	S.TRA 2SD1664 T100Q	B	125.1/47.6
Q1012	1590004090	S.TRA LDTC114YET1G <SLVJ>	B	130.9/20.7
Q1013	1510000920	S.TRA 2SA1577 T106 Q	T	107.7/44.3
Q1014	1520000460	S.TRA 2SB1132 T100 R	B	123.5/21.1
Q1015	1590004590	S.TRA DMC506010R	B	118.9/20.4
Q1016	1590004090	S.TRA LDTC114YET1G <SLVJ>	T	107.8/39.2
Q1017	1520000460	S.TRA 2SB1132 T100 R	T	120.1/35.2
Q1018	1590004090	S.TRA LDTC114YET1G <SLVJ>	B	126.4/43.3
Q1019	1590004590	S.TRA DMC506010R	B	123.8/35.8
Q1020	1590004090	S.TRA LDTC114YET1G <SLVJ>	T	42.6/22.5
Q1021	1590004090	S.TRA LDTC114YET1G <SLVJ>	B	126.4/41.3
Q2001	1590004040	S.TRA LDTA123YET1G <SLVJ>	B	26.9/26.6
D2	1750001910	S.DIO HVD144AKRF-E	B	52.6/28.5
D3	1750001910	S.DIO HVD144AKRF-E	B	52.6/27.3
D4	1750000711	S.VAR HVC350BTRF-E	B	36.0/40.2
D5	1750002060	S.DIO RNY52TE-21	T	26.5/53.3
D7	1750001910	S.DIO HVD144AKRF-E	B	25.3/45.3
D8	1750001910	S.DIO HVD144AKRF-E	B	43.4/27.3
D9	1750001910	S.DIO HVD144AKRF-E	B	43.4/28.6
D10	1750000711	S.VAR HVC350BTRF-E	B	55.5/39.9
D11	1750001820	S.DIO LRB706F-40T1G <SLVJ>	B	8.2/49.9
D12	1750001820	S.DIO LRB706F-40T1G <SLVJ>	B	28.8/49.9
D13	1750001910	S.DIO HVD144AKRF-E	T	66.3/28.1
D14	1750001910	S.DIO HVD144AKRF-E	T	69.5/28.1
D15	1790001261	S.DIO MA2S077G0L	B	82.2/39.2
D16	1750000711	S.VAR HVC350BTRF-E	B	106.7/20.3
D17	1750001910	S.DIO HVD144AKRF-E	T	70.6/41.6
D18	1750001910	S.DIO HVD144AKRF-E	T	74.5/41.6
D19	1750000711	S.VAR HVC350BTRF-E	B	61.9/39.9
D20	1750000711	S.VAR HVC350BTRF-E	B	28.0/40.2
D21	1750000711	S.VAR HVC350BTRF-E	B	36.0/41.6
D22	1750000711	S.VAR HVC350BTRF-E	B	28.0/41.6
D23	1750000711	S.VAR HVC350BTRF-E	B	52.8/42.6
D24	1750002060	S.DIO RNY52TE-21	T	35.1/56.7
D25	1750000581	S.DIO 1SV307(TPH3F)	B	83.5/42.1

[MAIN-A UNIT] (For [Low band] versions)

REF NO.	PARTS NO.	DESCRIPTION	M.	H/V LOCATION
D26	1750001650	S.VAR 1SV309(TPH3F)	B	101.8/25.9
D29	1750001820	S.DIO LRB706F-40T1G <SLVJ>	B	19.2/49.9
D33	1750000711	S.VAR HVC350BTRF-E	B	97.8/20.5
D62	1750000711	S.VAR HVC350BTRF-E	B	91.7/22.8
D64	1750002270	S.VAR HVD396CKRF-E	B	106.7/21.5
D66	1750000370	S.DIO DA221 TL	T	33.7/37.1
D67	1750002170	S.DIO DB2S31400L [EUR-01]	T	31.8/39.7
	1750002170	S.DIO DB2S31400L [EXP-01]		
	1790001241	S.DIO MA2S7280GL [USA-01]		
	1750002270	S.DIO MA2S7280GL [EXP-03]		
	1750002170	S.DIO DB2S31400L [CHN-01]		
D1002	1790000700	DIO DSA3A1		
D1003	1750000370	S.DIO DA221 TL	B	114.0/8.2
D1004	1750000370	S.DIO DA221 TL	B	114.1/6.1
D1005	1750000370	S.DIO DA221 TL	T	113.2/7.4
D1006	1750000370	S.DIO DA221 TL	T	113.0/10.3
D1007	1750001810	S.DIO L1SS400T1G <SLVJ>	B	129.0/20.7
D1008	1750000370	S.DIO DA221 TL	B	124.0/43.3
D2002	1750002170	S.DIO DB2S31400L [EUR-01]	T	24.9/18.0
	1750002170	S.DIO DB2S31400L [EXP-01]		
	1790001241	S.DIO MA2S7280GL [USA-01]		
	1790001241	S.DIO MA2S7280GL [EXP-03]		
	1750002170	S.DIO DB2S31400L [CHN-01]		
D2003	1750002170	S.DIO DB2S31400L [EUR-01]	B	10.7/30.5
	1750002170	S.DIO DB2S31400L [EXP-01]		
	1790001241	S.DIO MA2S7280GL [USA-01]		
	1750002170	S.DIO DB2S31400L [EXP-01]		
	1790001241	S.DIO MA2S7280GL [EXP-03]		
	1790001241	S.DIO MA2S7280GL [EXP-03]		
	1750002170	S.DIO DB2S31400L [CHN-01]		
D2004	1750002170	S.DIO DB2S31400L [EUR-01]	B	22.1/21.4
	1750002170	S.DIO DB2S31400L [EXP-01]		
	1790001241	S.DIO MA2S7280GL [USA-01]		
	1790001241	S.DIO MA2S7280GL [EXP-03]		
	1750002170	S.DIO DB2S31400L [CHN-01]		
D2005	1750002170	S.DIO DB2S31400L [EUR-01]	B	17.5/26.3
	1750002170	S.DIO DB2S31400L [EXP-01]		
	1790001241	S.DIO MA2S7280GL [USA-01]		
	1790001241	S.DIO MA2S7280GL [EXP-03]		
	1750002170	S.DIO DB2S31400L [CHN-01]		
D2006	1750002170	S.DIO DB2S31400L [EUR-01]	T	12.0/25.3
	1750002170	S.DIO DB2S31400L [EXP-01]		
	1790001241	S.DIO MA2S7280GL [USA-01]		
	1790001241	S.DIO MA2S7280GL [EXP-03]		
	1750002170	S.DIO DB2S31400L [CHN-01]		
D2008	1750002020	S.DIO DA2S10100L	T	100.3/6.5
F11	2020002570	CER LTM450HW <JJE>		
F12	2020002410	CER LTM450FW <JJE>		
F13	2020002610	S.CER LTUCG450G <JJE>	T	36.3/28.0
F14	2030000870	S.MON MFT46.3P3 46.350 MHz (FL-442)	T	66.9/34.9
F15	2010002760	S.XTA MFT46.3J 46.350 MHz (FL-448)	T	75.8/34.9
F16	2040001440	S.LC NFE31PT152Z1E9L (NFM60R20T152)	B	97.7/62.2
F17	2040001440	S.LC NFE31PT152Z1E9L (NFM60R20T152)	B	97.7/58.9
F18	2040001440	S.LC NFE31PT152Z1E9L (NFM60R20T152) [USA-01]	B	97.7/55.4
	2040001440	S.LC NFE31PT152Z1E9L (NFM60R20T152) [EXP-03]		
	2040001440	S.LC NFE31PT152Z1E9L (NFM60R20T152) [CHN-01]		
X1	6070000300	S.DIS JTBM450CX24 <JJE>	B	51.4/22.5
X2	6050013000	S.XTA CR-892 TTS14VSB-A8 15.3 MHz	B	71.5/21.0
X2001	6050013170	S.XTA CR-914 TTS18VSE-A11 12.288 MHz	B	27.0/18.2
L1	6200010150	S.COI AS080340-15N	B	8.4/62.7
L2	6200010150	S.COI AS080340-15N	B	12.9/55.5
L3	6200010150	S.COI AS080340-15N	B	20.7/55.5
L4	6200013100	S.COI 0.45-1.5-STL 18.3N <COMO>	T	31.1/50.5
L5	6200010420	S.COI FHW1210HC 1R0JGT <JJE>	T	38.5/58.4
L6	6200010150	S.COI AS080340-15N	B	27.3/55.5
L7	6200012870	S.COI 0.30-1.4-5TR 23.5N <COMO>	B	28.8/37.8
L8	6200012870	S.COI 0.30-1.4-5TR 23.5N <COMO>	B	35.2/37.8
L9	6200012170	S.COI MLG1608S R18J-T	B	65.8/24.7
L10	6200011690	S.COI C2520C-12NG-A	B	49.0/39.8
L11	6200011690	S.COI C2520C-12NG-A	B	57.8/40.5
L12	6200012170	S.COI MLG1608S R18J-T	B	62.3/22.4
L13	6200007901	S.COI ELJRF 22NJFB	T	85.1/29.9
L16	6200010150	S.COI AS080340-15N	B	38.2/65.2
L17	6200005661	S.COI ELJRE 10NGFA	B	85.4/57.9
L18	6200005701	S.COI ELJRE 22NGFA	B	88.1/58.9
L19	6200005711	S.COI ELJRE 27NGFA	B	89.9/56.0
L20	6200010090			

[MAIN-A UNIT] (For [Low band] versions)

REF NO.	PARTS NO.	DESCRIPTION	M.	H/V LOCATION
L54	6200007370	S.COI ELJFC R82K-F	T	100.0/30.4
L55	6200004741	S.COI NLV25T-1R2J	B	103.7/33.8
L56	6200011690	S.COI C2520C-12NG-A	B	64.2/40.5
L57	6200011860	S.COI LQW18ANR47G00D	B	92.6/24.0
L58	6200011860	S.COI LQW18ANR47G00D	B	105.9/19.1
L1001	6200004660	S.COI MLF1608A 1R8K-T	T	79.8/13.3
L2001	6200014160	S.COI VLFC4028T-100M1R0-2	T	35.9/7.6
L2002	6200007830	S.COI ELJFC 4R7K-F	B	31.2/11.2
R1	7030000620	S.RES MCR10EZJH 100 K (104)	B	12.3/65.5
R4	7030003560	S.RES ERJ3GEYJ 103 V (10K)	B	16.4/50.6
R5	7030008010	S.RES ERJ2GEJ 123 X (12K) [EUR-01]	B	11.2/49.6
	7030008010	S.RES ERJ2GEJ 123 X (12K) [EXP-01]		
	7030005220	S.RES ERJ2GEJ 223 X (22K) [USA-01]		
	7030005220	S.RES ERJ2GEJ 223 X (22K) [EXP-03]		
	7030005220	S.RES ERJ2GEJ 223 X (22K) [CHN-01]		
R6	7030008010	S.RES ERJ2GEJ 123 X (12K) [EUR-01]	B	19.8/48.1
	7030008010	S.RES ERJ2GEJ 123 X (12K) [EXP-01]		
	7030005220	S.RES ERJ2GEJ 223 X (22K) [USA-01]		
	7030005220	S.RES ERJ2GEJ 223 X (22K) [EXP-03]		
	7030005220	S.RES ERJ2GEJ 223 X (22K) [CHN-01]		
R7	7030003560	S.RES ERJ3GEYJ 103 V (10K)	B	8.2/53.2
R8	7030006070	S.RES ERJ12YJ101U (100)	B	45.7/51.9
R9	7030003560	S.RES ERJ3GEYJ 103 V (10K)	B	25.6/50.6
R10	7030008010	S.RES ERJ2GEJ 123 X (12K) [EUR-01]	B	22.2/48.1
	7030008010	S.RES ERJ2GEJ 123 X (12K) [EXP-01]		
	7030005220	S.RES ERJ2GEJ 223 X (22K) [USA-01]		
	7030005220	S.RES ERJ2GEJ 223 X (22K) [EXP-03]		
	7030005220	S.RES ERJ2GEJ 223 X (22K) [CHN-01]		
R11	7030005050	S.RES ERJ2GEJ 103 X (10K)	B	31.5/40.5
R12	7030004980	S.RES ERJ2GEJ 101 X (100)	B	39.2/39.5
R13	7030005050	S.RES ERJ2GEJ 103 X (10K)	B	32.5/40.5
R14	7030005050	S.RES ERJ2GEJ 103 X (10K)	B	32.5/38.8
R15	7030005700	S.RES ERJ2GEJ 274 X (270K)	B	39.2/38.6
R16	7030004990	S.RES ERJ2GEJ 221 X (220) [EUR-01]	B	39.5/40.7
	7030004980	S.RES ERJ2GEJ 101 X (100) [EXP-01]		
	7030004980	S.RES ERJ2GEJ 101 X (100) [USA-01]		
	7030004980	S.RES ERJ2GEJ 101 X (100) [EXP-03]		
	7030004980	S.RES ERJ2GEJ 101 X (100) [CHN-01]		
R17	7030005530	S.RES ERJ2GEJ 100 X (10)	B	51.5/40.2
R18	7030005050	S.RES ERJ2GEJ 103 X (10K)	B	60.8/40.5
R19	7030005090	S.RES ERJ2GEJ 104 X (100K)	B	39.2/36.8
R20	7030005120	S.RES ERJ2GEJ 102 X (1K)	B	52.8/38.6
R21	7030005050	S.RES ERJ2GEJ 103 X (10K)	B	54.1/40.2
R22	7030005050	S.RES ERJ2GEJ 103 X (10K)	B	56.2/37.4
R23	7030005050	S.RES ERJ2GEJ 103 X (10K)	B	54.1/41.2
R29	7030009200	S.RES ERJ2GEJ 390 X (39) [EUR-01]	B	74.0/40.6
	7030005570	S.RES ERJ2GEJ 820 X (82) [EXP-01]		
	7030005570	S.RES ERJ2GEJ 820 X (82) [USA-01]		
	7030005570	S.RES ERJ2GEJ 820 X (82) [EXP-03]		
	7030005570	S.RES ERJ2GEJ 820 X (82) [CHN-01]		
R30	7030007300	S.RES ERJ2GEJ 332 X (3.3K)	B	71.3/41.2
R31	7030004980	S.RES ERJ2GEJ 101 X (100)	B	66.9/37.4
R33	7030005600	S.RES ERJ2GEJ 273 X (27K)	T	71.9/42.7
R34	7030005110	S.RES ERJ2GEJ 224 X (220K)	T	64.9/23.1
R35	7030005530	S.RES ERJ2GEJ 100 X (10)	T	64.9/22.2
R36	7030005030	S.RES ERJ2GEJ 152 X (1.5K)	B	56.2/21.7
R37	7030008400	S.RES ERJ2GEJ 182 X (1.8K)	B	56.6/25.5
R38	7030005090	S.RES ERJ2GEJ 104 X (100K)	T	61.7/17.8
R39	7030004970	S.RES ERJ2GEJ 470 X (47)	B	58.4/22.2
R40	7030005030	S.RES ERJ2GEJ 152 X (1.5K)	B	58.4/23.2
R41	7030010040	S.RES ERJ2GEJ-JPW	T	60.8/17.8
R42	7030005070	S.RES ERJ2GEJ 683 X (68K)	T	51.0/24.3
R43	7030005000	S.RES ERJ2GEJ 471 X (470)	T	55.6/19.1
R44	7030005310	S.RES ERJ2GEJ 124 X (120K)	T	54.0/24.7
R45	7030005310	S.RES ERJ2GEJ 124 X (120K)	T	52.2/24.7
R46	7030008410	S.RES ERJ2GEJ 392 X (3.9K)	T	54.0/22.9
R48	7030008300	S.RES ERJ2GEJ 184 X (180K) [USA-01]	T	56.8/53.2
	7030008300	S.RES ERJ2GEJ 184 X (180K) [EXP-03]		
	7030008300	S.RES ERJ2GEJ 184 X (180K) [CHN-01]		
R49	7520000241	S.POS PRF18BC471QB5RB [USA-01]	T	47.3/53.2
	7520000241	S.POS PRF18BC471QB5RB [EXP-03]		
	7520000241	S.POS PRF18BC471QB5RB [CHN-01]		
R50	7030005050	S.RES ERJ2GEJ 103 X (10K)	B	80.1/37.9
R51	7030008290	S.RES ERJ2GEJ 183 X (18K) [EUR-01]	T	61.8/49.8
	7030008290	S.RES ERJ2GEJ 183 X (18K) [EXP-01]		
	7030005080	S.RES ERJ2GEJ 823 X (82K) [USA-01]		
	7030005080	S.RES ERJ2GEJ 823 X (82K) [EXP-03]		
	7030005080	S.RES ERJ2GEJ 823 X (82K) [CHN-01]		
R52	7030005070	S.RES ERJ2GEJ 683 X (68K)	T	58.7/52.1
R53	7030004990	S.RES ERJ2GEJ 221 X (220)	T	57.8/53.2
R54	7030005050	S.RES ERJ2GEJ 103 X (10K) [EUR-01]	B	58.8/55.7
	7030005050	S.RES ERJ2GEJ 103 X (10K) [EXP-01]		
	7030005220	S.RES ERJ2GEJ 223 X (22K) [USA-01]		
	7030005220	S.RES ERJ2GEJ 223 X (22K) [EXP-03]		
	7030005220	S.RES ERJ2GEJ 223 X (22K) [CHN-01]		
R56	7030005110	S.RES ERJ2GEJ 224 X (220K) [EUR-01]	T	63.3/55.0
	7030005110	S.RES ERJ2GEJ 224 X (220K) [EXP-01]		
	7030005100	S.RES ERJ2GEJ 154 X (150K) [USA-01]		
	7030005100	S.RES ERJ2GEJ 154 X (150K) [EXP-03]		
	7030005100	S.RES ERJ2GEJ 154 X (150K) [CHN-01]		
R57	7030005050	S.RES ERJ2GEJ 103 X (10K)	B	58.8/54.8
R58	7030004980	S.RES ERJ2GEJ 101 X (100)	T	64.2/55.0
R59	7030008290	S.RES ERJ2GEJ 183 X (18K) [EUR-01]	T	59.7/52.1
	7030008290	S.RES ERJ2GEJ 183 X (18K) [EXP-01]		
	7030007350	S.RES ERJ2GEJ 393 X (39K) [USA-01]		
	7030007350	S.RES ERJ2GEJ 393 X (39K) [EXP-03]		
	7030007350	S.RES ERJ2GEJ 393 X (39K) [CHN-01]		
R61	7030004970	S.RES ERJ2GEJ 470 X (47)	B	90.5/49.5
R62	7030008290	S.RES ERJ2GEJ 183 X (18K)	B	89.6/49.5
R66	7030005090	S.RES ERJ2GEJ 104 X (100K)	B	84.9/49.1
R67	7030004980	S.RES ERJ2GEJ 101 X (100)	B	83.0/47.3
R68	7030005050	S.RES ERJ2GEJ 103 X (10K)	B	82.6/48.7
R69	7030005040	S.RES ERJ2GEJ 472 X (4.7K)	B	84.0/38.0

[MAIN-A UNIT] (For [Low band] versions)

REF NO.	PARTS NO.	DESCRIPTION	M.	H/V LOCATION
R70	7030004990	S.RES ERJ2GEJ 221 X (220)	B	92.8/35.8
R71	7030007260	S.RES ERJ2GEJ 330 X (33)	B	95.3/33.8
R72	7030004980	S.RES ERJ2GEJ 101 X (100)	B	86.5/49.1
R73	7030005000	S.RES ERJ2GEJ 471 X (470) [EUR-01]	B	99.5/35.3
	7030004980	S.RES ERJ2GEJ 101 X (100) [EXP-01]		
	7030004980	S.RES ERJ2GEJ 101 X (100) [USA-01]		
	7030004980	S.RES ERJ2GEJ 101 X (100) [EXP-03]		
	7030004980	S.RES ERJ2GEJ 101 X (100) [CHN-01]		
R74	7030005080	S.RES ERJ2GEJ 823 X (82K)	B	101.3/35.7
R75	7030005720	S.RES ERJ2GEJ 563 X (56K)	B	97.6/32.2
R76	7030009270	S.RES ERJ2GEJ 821 X (820)	B	96.7/32.2
R77	7030005120	S.RES ERJ2GEJ 102 X (1K)	T	105.6/36.0
R78	7030008370	S.RES ERJ2GEJ 561 X (560)	T	102.5/32.5
R79	7030006020	S.RES RR0510P-682-D (6.8K)	B	96.5/23.7
R80	7030009270	S.RES ERJ2GEJ 821 X (820)	T	100.0/32.5
R83	7030006020	S.RES RR0510P-682-D (6.8K)	B	106.4/29.1
R84	7030006020	S.RES RR0510P-682-D (6.8K)	B	106.4/29.2
R85	7030006020	S.RES RR0510P-682-D (6.8K)	B	95.6/25.3
R86	7030005110	S.RES ERJ2GEJ 224 X (220K)	B	102.6/24.4
R87	7030005530	S.RES ERJ2GEJ 100 X (10)	B	102.6/27.5
R89	7030005050	S.RES ERJ2GEJ 103 X (10K)	T	79.0/25.0
R90	7030005170	S.RES ERJ2GEJ 474 X (470K)	T	95.9/15.3
R92	7030005100	S.RES ERJ2GEJ 154 X (150K)	T	94.3/14.4
R93	7030005600	S.RES ERJ2GEJ 273 X (27K)	B	81.3/25.8
R95	7030005710	S.RES ERJ2GEJ 121 X (120)	B	83.8/24.5
R96	7030007290	S.RES ERJ2GEJ 222 X (2.2K)	B	83.8/23.5
R97	7030010040	S.RES ERJ2GEJ-JPW	B	82.2/24.5
R98	7030007290	S.RES ERJ2GEJ 222 X (2.2K)	T	109.5/33.8
R100	7030005240	S.RES ERJ2GEJ 473 X (47K)	T	76.1/20.3
R101	7030004980	S.RES ERJ2GEJ 101 X (100)	T	77.9/22.2
R123	7030005530	S.RES ERJ2GEJ 100 X (10)	T	68.2/40.4
R125	7030008370	S.RES ERJ2GEJ 561 X (560)	T	65.6/29.2
R171	7030004980	S.RES ERJ2GEJ 101 X (100)	T	45.5/28.6
R172	7030008300	S.RES ERJ2GEJ 184 X (180K)	T	44.2/27.1
R173	7030005120	S.RES ERJ2GEJ 102 X (1K)	T	42.9/26.4
R174	7030005290	S.RES ERJ2GEJ 682 X (6.8K)	T	42.0/28.8
R175	7030009290	S.RES ERJ2GEJ 562 X (5.6K)	T	41.6/27.6
R176	7030005030	S.RES ERJ2GEJ 152 X (1.5K)	T	42.0/26.4
R178	7030004970	S.RES ERJ2GEJ 470 X (47)	B	39.8/24.4
R211	7030004970	S.RES ERJ2GEJ 470 X (47)	T	82.7/28.3
R212	7030010040	S.RES ERJ2GEJ-JPW	T	82.6/60.4
R234	7030005720	S.RES ERJ2GEJ 563 X (56K) [EUR-01]	B	92.8/34.9
	7030005070	S.RES ERJ2GEJ 683 X (68K) [EXP-01]		
	7030005070	S.RES ERJ2GEJ 683 X (68K) [USA-01]		
	7030005070	S.RES ERJ2GEJ 683 X (68K) [EXP-03]		
	7030005070	S.RES ERJ2GEJ 683 X (68K) [CHN-01]		
R235	7030004980	S.RES ERJ2GEJ 101 X (100)	B	81.0/37.9
R236	7030007570	S.RES ERJ2GEJ 122 X (1.2K)	B	67.4/22.7
R237	7030007060	S.RES ERJ2GEJ 684X (680K)	B	67.4/23.6
R289	7030005240	S.RES ERJ2GEJ 473 X (47K)	T	95.9/12.6
R290	7030005010	S.RES ERJ2GEJ 681 X (680)	T	63.2/23.1
R291	7030005090	S.RES ERJ2GEJ 104 X (100K)	T	94.3/13.5
R293	7030006610	S.RES ERJ2GEJ 394 X (390K)	T	88.4/12.0
R295	7030006610	S.RES ERJ2GEJ 394 X (390K)	T	101.0/17.3
R299	7030008300	S.RES ERJ2GEJ 184 X (180K)	B	74.6/38.5
R300	7030005720	S.RES ERJ2GEJ 563 X (56K)	B	76.8/40.6
R301	7030005100	S.RES ERJ2GEJ 154 X (150K)	B	67.5/40.5
R302	7030005720	S.RES ERJ2GEJ 563 X (56K)	B	66.9/38.3
R308	7030009140	S.RES ERJ2GEJ 272 X (2.7K)	T	56.9/54.9
R311	7030010040	S.RES ERJ2GEJ-JPW	B	94.9/32.2
R317	7030005120	S.RES ERJ2GEJ 102 X (1K)	T	105.6/37.4
R319	7030007340	S.RES ERJ2GEJ 153 X (15K)	T	37.3/37.9
R320	7030005170	S.RES ERJ2GEJ 474 X (470K)	T	35.5/36.2
R328	7030010040	S.RES ERJ2GEJ-JPW	B	104.8/29.1
R334	7030005000	S.RES ERJ2GEJ 471 X (470)	T	87.6/61.3
R337	7030005530	S.RES ERJ2GEJ 100 X (10)	T	87.1/62.7
R338	7030005000	S.RES ERJ2GEJ 471 X (470)	T	87.6/64.1
R339	7030010040	S.RES ERJ2GEJ-JPW	B	96.5/25.3
R340	7030005050	S.RES ERJ2GEJ 103 X (10K)	B	72.4/25.3
R350	7030005600	S.RES ERJ2GEJ 273 X (27K)	B	52.9/26.2
R351	7030005600	S.RES ERJ2GEJ 273 X (27K)	B	43.2/26.3
R352	7030007300	S.RES ERJ2GEJ 332 X (3.3K)	B	50.9/26.8
R353	7030005210	S.RES ERJ2GEJ 822 X (8.2K)	B	45.4/27.3
R354	7030005210	S.RES ERJ2GEJ 822 X (8.2K)	B	46.1/29.0
R394	7030010040	S.RES ERJ2GEJ-JPW	B	100.1/27.3
R395	7030010040	S.RES ERJ2GEJ-JPW	B	26.7/46.8
R478	7030007340	S.RES ERJ2GEJ 153 X (15K)	B	35.5/26.3
R479	7030005600	S.RES ERJ2GEJ 273 X (27K)	T	66.8/27.4
R483	7030007300	S.RES ERJ2GEJ 332 X (3.3K)	T	71.5/28.8
R484	7030007300	S.RES ERJ2GEJ 332 X (3.3K)	T	76.5/42.5
R485	7030010040	S.RES ERJ2GEJ-JPW	T	77.0/40.4
R486	7030005000	S.RES ERJ2GEJ 471 X (470)	T	73.2/29.7
R488	7030007300	S.RES ERJ2GEJ 332 X (3.3K)	T	68.6/42.7
R489	7030007300	S.RES ERJ2GEJ 332 X (3.3K)	T	68.

[MAIN-A UNIT] (For [Low band] versions)

REF NO.	PARTS NO.	DESCRIPTION	M.	H/V LOCATION
R1005	7030005120	S.RES ERJ2GGEJ 102 X (1K)	T	112.3/16.5
R1006	7030005090	S.RES ERJ2GGEJ 104 X (100K)	B	112.4/8.1
R1008	7030010040	S.RES ERJ2GGEJ-JPW	T	124.9/24.8
R1009	7030005050	S.RES ERJ2GGEJ 103 X (10K)	T	133.3/49.2
R1010	7030005050	S.RES ERJ2GGEJ 103 X (10K)	T	128.6/23.5
R1012	7030005040	S.RES ERJ2GGEJ 472 X (4.7K)	T	110.6/46.0
R1013	7030005240	S.RES ERJ2GGEJ 473 X (47K)	T	114.7/24.0
R1014	7030005090	S.RES ERJ2GGEJ 104 X (100K)	T	98.3/12.1
R1015	7030005120	S.RES ERJ2GGEJ 102 X (1K)	B	115.3/22.8
R1016	7030005090	S.RES ERJ2GGEJ 104 X (100K)	B	115.6/6.1
R1018	7030005090	S.RES ERJ2GGEJ 104 X (100K)	T	111.7/7.0
R1020	7030005090	S.RES ERJ2GGEJ 104 X (100K)	B	114.7/24.9
R1021	7030005120	S.RES ERJ2GGEJ 102 X (1K)	B	116.5/6.1
R1022	7030005120	S.RES ERJ2GGEJ 102 X (1K)	T	114.9/7.1
R1023	7030005050	S.RES ERJ2GGEJ 103 X (10K)	B	125.2/15.7
R1024	7030007290	S.RES ERJ2GGEJ 222 X (2.2K)	B	131.6/17.6
R1025	7030000480	S.RES MCR10EZHJ 6.8K (682)	B	129.4/47.0
R1026	7030000480	S.RES MCR10EZHJ 6.8K (682)	B	129.4/48.8
R1027	7030010040	S.RES ERJ2GGEJ-JPW	T	113.7/16.5
R1028	7030004970	S.RES ERJ2GGEJ 470 X (47K)	B	114.9/13.4
R1029	7030005120	S.RES ERJ2GGEJ 102 X (1K)	T	115.3/10.5
R1030	7030005050	S.RES ERJ2GGEJ 103 X (10K)	T	114.4/10.5
R1031	7030005050	S.RES ERJ2GGEJ 103 X (10K)	B	117.8/7.7
R1032	7030005050	S.RES ERJ2GGEJ 103 X (10K)	B	127.1/19.9
R1033	7030000480	S.RES MCR10EZHJ 6.8K (682)	B	129.4/45.2
R1034	7030005040	S.RES ERJ2GGEJ 472 X (4.7K)	B	123.6/17.5
R1035	7030005050	S.RES ERJ2GGEJ 103 X (10K)	T	107.8/42.5
R1036	7030005040	S.RES ERJ2GGEJ 472 X (4.7K)	T	107.8/41.2
R1037	7030005090	S.RES ERJ2GGEJ 104 X (100K)	T	95.9/13.5
R1038	7030005120	S.RES ERJ2GGEJ 102 X (1K)	B	125.6/36.3
R1039	7030005090	S.RES ERJ2GGEJ 104 X (100K)	B	113.7/12.9
R1040	7030005160	S.RES ERJ2GGEJ 105 X (1M)	T	111.2/12.9
R1043	7030005160	S.RES ERJ2GGEJ 105 X (1M)	B	112.0/11.0
R1044	7030005090	S.RES ERJ2GGEJ 104 X (100K)	B	117.9/9.9
R1045	7030005050	S.RES ERJ2GGEJ 103 X (10K)	B	120.4/17.1
R1046	7030005800	S.RES RR0510P-102-D (1K)	B	119.7/9.0
R1047	7030005050	S.RES ERJ2GGEJ 103 X (10K)	B	119.4/18.6
R1048	7030009710	S.RES ERJ2GGEJ 203 X (20K)	B	119.0/22.4
R1049	7030005040	S.RES ERJ2GGEJ 472 X (4.7K)	B	116.7/19.7
R1050	7030007290	S.RES ERJ2GGEJ 222 X (2.2K)	B	123.0/38.1
R1054	7030008270	S.RES RR0510P-104-D (100K)	B	119.7/9.9
R1055	7030005090	S.RES ERJ2GGEJ 104 X (100K)	B	120.4/15.2
R1056	7030008270	S.RES RR0510P-104-D (100K)	B	118.8/10.8
R1057	7030005100	S.RES ERJ2GGEJ 154 X (150K)	B	118.8/15.2
R1059	7410001130	S.ARR EXB28V102JX	T	69.7/14.8
R1060	7410001130	S.ARR EXB28V102JX	T	63.4/14.8
R1062	7030008270	S.RES RR0510P-104-D (100K)	B	116.0/14.8
R1063	7030007340	S.RES ERJ2GGEJ 153 X (15K)	B	42.8/22.4
R1064	7030005090	S.RES ERJ2GGEJ 104 X (100K)	T	40.5/23.1
R1068	7030005120	S.RES ERJ2GGEJ 102 X (1K)	T	74.3/14.1
R1069	7030005120	S.RES ERJ2GGEJ 102 X (1K)	T	72.6/14.1
R1070	7030005120	S.RES ERJ2GGEJ 102 X (1K)	T	57.3/15.1
R1071	7030005090	S.RES ERJ2GGEJ 104 X (100K)	T	51.7/16.7
R1072	7030005040	S.RES ERJ2GGEJ 472 X (4.7K)	T	52.9/16.3
R1073	7030005700	S.RES ERJ2GGEJ 274 X (270K)	B	50.8/18.7
R1074	7030005100	S.RES ERJ2GGEJ 154 X (150K)	T	32.7/20.6
R1075	7030008010	S.RES ERJ2GGEJ 123 X (12K)	T	36.3/21.5
R1076	7030005090	S.RES ERJ2GGEJ 104 X (100K)	B	35.0/20.5
R1077	7030005170	S.RES ERJ2GGEJ 474 X (470K)	B	36.6/20.2
R1078	7030005090	S.RES ERJ2GGEJ 104 X (100K)	B	32.2/15.2
R1080	7030005310	S.RES ERJ2GGEJ 124 X (120K)	B	40.1/13.5
R1081	7030008290	S.RES ERJ2GGEJ 183 X (18K)	T	42.5/19.5
R1082	7410001130	S.ARR EXB28V102JX	T	56.9/6.7
R1083	7030005120	S.RES ERJ2GGEJ 102 X (1K)	B	69.1/8.8
R1084	7410001130	S.ARR EXB28V102JX	T	61.7/6.1
R1085	7030005120	S.RES ERJ2GGEJ 102 X (1K)	B	49.5/9.9
R1086	7030005100	S.RES ERJ2GGEJ 154 X (150K)	B	32.2/18.5
R1087	7030007340	S.RES ERJ2GGEJ 153 X (15K)	B	41.3/15.2
R1088	7030005160	S.RES ERJ2GGEJ 105 X (1M)	B	31.3/16.9
R1089	7030005050	S.RES ERJ2GGEJ 103 X (10K)	B	44.2/16.9
R1090	7030008300	S.RES ERJ2GGEJ 184 X (180K)	B	36.5/13.4
R1092	7030008400	S.RES ERJ2GGEJ 182 X (1.8K)	B	38.3/13.5
R1093	7030005090	S.RES ERJ2GGEJ 104 X (100K)	B	42.9/15.5
R1094	7030005090	S.RES ERJ2GGEJ 104 X (100K)	T	55.7/12.8
R1095	7030009290	S.RES ERJ2GGEJ 562 X (5.6K)	T	55.7/13.7
R1096	7030005100	S.RES ERJ2GGEJ 154 X (150K)	B	35.6/13.4
R1097	7030007290	S.RES ERJ2GGEJ 222 X (2.2K)	T	55.2/11.6
R1098	7510001730	S.THE ERTJJOEP 474J	T	74.9/15.5
R1099	7030008270	S.RES RR0510P-104-D (100K)	T	72.5/15.5
R1100	7410001130	S.ARR EXB28V102JX	T	75.3/6.0
R1101	7030005290	S.RES ERJ2GGEJ 682 X (6.8K)	B	44.0/20.4
R1102	7030005040	S.RES ERJ2GGEJ 472 X (4.7K)	B	42.4/16.4
R1103	7030005290	S.RES ERJ2GGEJ 682 X (6.8K)	B	52.9/18.3
R1105	7030003860	S.RES ERJ3GE JPW V	T	127.8/48.9
R1106	7030009290	S.RES ERJ2GGEJ 562 X (5.6K)	B	41.0/20.8
R1107	7030008410	S.RES ERJ2GGEJ 392 X (3.9K)	B	39.2/20.8
R1108	7030005240	S.RES ERJ2GGEJ 473 X (47K)	B	124.9/41.7
R1111	7030005060	S.RES ERJ2GGEJ 333 X (33K)	T	36.3/19.7
R1112	7030005230	S.RES ERJ2GGEJ 334 X (330K)	B	41.5/19.6
R1113	7030005720	S.RES ERJ2GGEJ 563 X (56K)	B	44.0/21.3
R1114	7030005120	S.RES ERJ2GGEJ 102 X (1K)	T	65.8/6.4
R1115	7030005120	S.RES ERJ2GGEJ 102 X (1K)	T	65.8/5.4
R1116	7030007300	S.RES ERJ2GGEJ 332 X (3.3K)	T	73.7/15.0
R1117	7030005090	S.RES ERJ2GGEJ 104 X (100K)	B	42.4/18.2
R1119	7030003860	S.RES ERJ3GE JPW V	T	99.5/68.6
	7030003860	S.RES ERJ3GE JPW V	[USA-01] [EXP-03] [CHN-01]	
R2003	7030007250	S.RES ERJ2GGEJ 220 X (22)	B	16.7/6.8
R2004	7030005210	S.RES ERJ2GGEJ 822 X (8.2K)	B	12.6/8.8
R2005	7030005210	S.RES ERJ2GGEJ 822 X (8.2K)	B	15.8/6.8
R2009	7030007290	S.RES ERJ2GGEJ 222 X (2.2K)	B	10.5/11.7
R2010	7030004980	S.RES ERJ2GGEJ 101 X (100)	T	11.5/11.7
R2011	7030004980	S.RES ERJ2GGEJ 101 X (100)	T	23.0/10.4
R2012	7030004980	S.RES ERJ2GGEJ 101 X (100)	T	22.5/11.3
R2013	7030005240	S.RES ERJ2GGEJ 473 X (47K)	B	19.8/12.0

[MAIN-A UNIT] (For [Low band] versions)

REF NO.	PARTS NO.	DESCRIPTION	M.	H/V LOCATION
R2015	7030005240	S.RES ERJ2GGEJ 473 X (47K)	T	18.4/11.6
R2016	7030010040	S.RES ERJ2GGEJ-JPW	B	24.0/5.8
R2019	7030010040	S.RES ERJ2GGEJ-JPW	B	9.9/17.9
R2020	7030010040	S.RES ERJ2GGEJ-JPW	B	14.4/11.1
R2021	7030004980	S.RES ERJ2GGEJ 101 X (100)	B	23.6/12.1
R2022	7030004980	S.RES ERJ2GGEJ 101 X (100)	B	27.9/24.7
R2024	7030005240	S.RES ERJ2GGEJ 473 X (47K)	B	26.6/21.6
R2026	7030004970	S.RES ERJ2GGEJ 470 X (47K)	B	27.9/22.9
R2028	7030005240	S.RES ERJ2GGEJ 473 X (47K)	B	12.1/19.3
R2030	7030005240	S.RES ERJ2GGEJ 473 X (47K)	B	11.0/21.2
R2031	7030005240	S.RES ERJ2GGEJ 473 X (47K)	B	10.7/29.4
R2032	7030005240	S.RES ERJ2GGEJ 473 X (47K)	B	24.9/17.4
R2034	7030005240	S.RES ERJ2GGEJ 473 X (47K)	B	28.8/10.5
R2035	7030005240	S.RES ERJ2GGEJ 473 X (47K)	B	26.7/14.9
R2036	7030004980	S.RES ERJ2GGEJ 101 X (100)	T	26.8/11.9
R2037	7030007290	S.RES ERJ2GGEJ 222 X (2.2K)	T	28.1/10.7
R2038	7030004970	S.RES ERJ2GGEJ 470 X (47K)	B	28.8/12.1
R2039	7030005240	S.RES ERJ2GGEJ 473 X (47K)	B	24.1/9.5
R2040	7030005240	S.RES ERJ2GGEJ 473 X (47K)	B	24.5/12.1
R2043	7410001140	S.ARR EXB28V104JX	T	15.6/26.7
R2044	7410001140	S.ARR EXB28V104JX	T	20.8/26.6
R2045	7410001140	S.ARR EXB28V104JX	B	27.0/22.3
R2046	7410001140	S.ARR EXB28V104JX	T	19.3/26.7
R2047	7410001140	S.ARR EXB28V104JX	B	10.9/14.5
R2048	7030005090	S.RES ERJ2GGEJ 104 X (100K)	T	25.7/14.6
R2049	7030005090	S.RES ERJ2GGEJ 104 X (100K)	B	21.8/15.6
R2050	7410001140	S.ARR EXB28V104JX	B	22.6/18.2
R2051	7410001140	S.ARR EXB28V104JX	T	9.9/11.6
R2052	7030005090	S.RES ERJ2GGEJ 104 X (100K)	T	16.8/11.7
R2053	7030005090	S.RES ERJ2GGEJ 104 X (100K)	B	16.0/14.5
R2056	7030010040	S.RES ERJ2GGEJ-JPW	T	10.6/20.0
R2057	7030005090	S.RES ERJ2GGEJ 104 X (100K)	T	10.4/22.9
R2058	7410001140	S.ARR EXB28V104JX	B	17.0/18.6
R2059	7030005090	S.RES ERJ2GGEJ 104 X (100K)	T	10.4/23.8
R2060	7030005090	S.RES ERJ2GGEJ 104 X (100K)	T	25.7/15.6
R2061	7030005090	S.RES ERJ2GGEJ 104 X (100K)	B	14.7/12.6
R2062	7030005090	S.RES ERJ2GGEJ 104 X (100K)	B	17.7/14.4
R2063	7030005090	S.RES ERJ2GGEJ 104 X (100K)	B	22.1/23.4
R2064	7030005090	S.RES ERJ2GGEJ 104 X (100K)	B	19.7/17.7
R2065	7030005030	S.RES ERJ2GGEJ 152 X (1.5K)	B	13.8/6.8
R2066	7410001170	S.ARR EXB28V470JX	T	21.3/6.7
R2067	7030010040	S.RES ERJ2GGEJ-JPW	T	11.4/5.3
R2068	7030010040	S.RES ERJ2GGEJ-JPW	T	20.9/10.4
R2071	7030010040	S.RES ERJ2GGEJ-JPW	T	24.9/5.7
R2072	7030005050	S.RES ERJ2GGEJ 103 X (10K)	B	12.2/10.1
R2074	7030010040	S.RES ERJ2GGEJ-JPW	T	8.7/10.0
R2084	7030010040	S.RES ERJ2GGEJ-JPW	T	30.7/10.5
R2085	7030010040	S.RES ERJ2GGEJ-JPW	B	19.5/9.6
C1	4030011070	S.CER GRM31M2C2H5R0CY21L (GRM42-6 CH)	B	8.4/66.6
C2	4030011070	S.CER GRM31M2C2H5R0CY21L (GRM42-6 CH)	B	7.4/58.6
C3	4030009500	S.CER C1608 CH 1H 0R5B-T	B	25.6/51.9
C4	4030009500	S.CER C1608 CH 1H 0R5B-T	B	16.4/51.9
C5	4030009500	S.CER C1608 CH 1H 0R5B-T	B	8.2/54.5
C6	4030011090	S.CER GRM31M2C2H7R0DV01L (GRM42-6 CH)	B	7.4/56.3
C7	4030011070	S.CER GRM31M2C2H5R0CY21L (GRM42-6 CH)	B	13.1/60.7
C8	4030011070	S.CER GRM31M2C2H5R0CY21L (GRM42-6 CH)	B	19.5/60.7
C9	4030011080	S.CER GRM31M2C2H6R0DV01L (GRM42-6 CH)	T	30.6/53.1
C10	4030017730	S.CER C1005 JB 1H 471K-T	B	18.1/48.1
C11	4030017730	S.CER C1005 JB 1H 471K-T	B	10.0/49.2
C12	4030017730	S.CER C1005 JB 1H 471K-T	T	39.4/54.4
C13	4030017420	S.CER C1005 CH 1H 470J-T	B	49.5/51.4
C14	4030019420	S.CER GRM31A7U2J102JW31D	B	34.9/55.5
C15	4030017570	S.CER C1005 CH 1H 050B-T	T	23.7/50.4
	4030017380	S.CER C1005 CH 1H 050B-T	[EXP-01]	
	4030017380	S.CER C1005 CH 1H 050B-T	[USA-01]	
	4030017380	S.CER C1005 CH 1H 050B-T	[EXP-03]	
	4030017380	S.CER C1005 CH 1H 050B-T	[CHN-01]	
C20	4030017400	S.CER C1005 CH 1H 220J-T	B	30.6/40.5
C21	4030017590	S.CER C1005 CH 1H 070C-T	B	26.7/38.1
C22	4030017360	S.CER C1005 CH 1H 030B-T	B	32.0/37.5
	4030017370	S.CER C1005 CH 1H 3R5B-T	[EXP-01]	
	4030017370	S.CER C1005 CH 1H 3R5B-T	[USA-01]	
	4030017370	S.CER C1005 CH 1H 3R5B-T	[EXP-03]	

[MAIN-A UNIT] (For [Low band] versions)

REF NO.	PARTS NO.	DESCRIPTION	M.	H/V LOCATION
C51	4030017460	S.CER C1005 JB 1H 102K-T	T	72.4/41.1
C52	4030017620	S.CER C1005 CH 1H 100C-T	B	70.4/41.2
C53	4030016790	S.CER C1005 JB 1E 103K-T	B	71.3/42.8
C54	4030017730	S.CER C1005 JB 1H 471K-T	B	70.4/42.8
C57	4030017460	S.CER C1005 JB 1H 102K-T	B	74.6/36.7
C58	4030017460	S.CER C1005 JB 1H 102K-T	T	67.2/26.1
C59	4030017460	S.CER C1005 JB 1H 102K-T	T	66.9/22.7
C60	4030016790	S.CER C1005 JB 1E 103K-T	T	65.3/26.6
C61	4030017430	S.CER C1005 CH 1H 101J-T	T	61.6/23.1
C62	4030017420	S.CER C1005 CH 1H 470J-T	B	57.1/24.3
C63	4030017420	S.CER C1005 CH 1H 470J-T	T	60.3/14.3
C64	4030016790	S.CER C1005 JB 1E 103K-T	B	56.2/26.8
C65	4030018860	S.CER C1005 JB 0J 105K-T	T	58.2/19.6
C66	4030017460	S.CER C1005 JB 1H 102K-T	T	54.7/19.9
C67	4030017460	S.CER C1005 JB 1H 102K-T	B	58.4/21.3
C68	4030017680	S.CER C1005 CH 1H 820J-T	T	52.2/23.8
C69	4030017710	S.CER C1005 CH 1H 181J-T	T	54.0/23.8
C70	4030017710	S.CER C1005 CH 1H 181J-T	T	54.0/25.6
C71	4030016930	S.CER C1005 JB 1A 104K-T	T	57.4/29.0
C72	4030017730	S.CER C1005 JB 1H 471K-T	T	59.8/48.0
	4030017730	S.CER C1005 JB 1H 471K-T	[USA-01]	
	4030017730	S.CER C1005 JB 1H 471K-T	[EXP-03]	
	4030017730	S.CER C1005 JB 1H 471K-T	[CHN-01]	
C74	4030017730	S.CER C1005 JB 1H 471K-T	B	11.2/50.5
C75	4030019560	S.CER GRM21BB31C106KE15L	T	61.6/25.3
C76	4030016790	S.CER C1005 JB 1E 103K-T	T	57.8/54.9
C77	4030017460	S.CER C1005 JB 1H 102K-T	T	56.8/50.7
C78	4030017730	S.CER C1005 JB 1H 471K-T	B	58.8/56.6
C79	4030017900	S.CER C1005 JB 1E 123K-T	T	62.4/55.0
	4030017900	S.CER C1005 JB 1E 123K-T	[EUR-01]	
	4030016960	S.CER C1005 JB 1E 183K-T	[EXP-01]	
	4030016960	S.CER C1005 JB 1E 183K-T	[USA-01]	
	4030016960	S.CER C1005 JB 1E 183K-T	[EXP-03]	
	4030016960	S.CER C1005 JB 1E 183K-T	[CHN-01]	
C80	4030017780	S.CER C1005 JB 1H 472K-T	T	60.6/52.1
C81	4030017460	S.CER C1005 JB 1H 102K-T	T	65.1/55.0
C82	4030011030	S.CER GRM31M4C2H1R5CY21L (GRM42-6 CK)	T	34.9/65.2
C84	4030017420	S.CER C1005 CH 1H 470J-T	T	55.0/61.6
C85	4030017460	S.CER C1005 JB 1H 102K-T	T	56.0/61.6
C86	4030017710	S.CER C1005 CH 1H 181J-T	T	81.3/63.8
C87	4030017460	S.CER C1005 JB 1H 102K-T	T	79.8/68.8
C88	4030017730	S.CER C1005 JB 1H 471K-T	T	64.6/52.1
C89	4030017580	S.CER C1005 CH 1H 060C-T	B	87.3/57.5
C90	4030017580	S.CER C1005 CH 1H 060C-T	B	88.2/57.5
C92	4030017570	S.CER C1005 CH 1H 040B-T	B	89.9/58.0
C93	4030017620	S.CER C1005 CH 1H 100C-T	B	86.9/51.5
C96	4030017460	S.CER C1005 JB 1H 102K-T	B	87.8/56.3
C97	4030017730	S.CER C1005 JB 1H 471K-T	B	87.8/55.4
C98	4030017620	S.CER C1005 CH 1H 100C-T	B	83.5/48.7
C99	4030017730	S.CER C1005 JB 1H 471K-T	B	81.4/48.3
C100	4030017620	S.CER C1005 CH 1H 100C-T	B	91.2/34.9
C102	4030017580	S.CER C1005 CH 1H 060C-T	B	97.1/33.8
	4030017380	S.CER C1005 CH 1H 050B-T	[EUR-01]	
	4030017380	S.CER C1005 CH 1H 050B-T	[EXP-01]	
	4030017380	S.CER C1005 CH 1H 050B-T	[USA-01]	
	4030017380	S.CER C1005 CH 1H 050B-T	[EXP-03]	
	4030017380	S.CER C1005 CH 1H 050B-T	[CHN-01]	
C103	4030017350	S.CER C1005 CH 1H 020B-T	B	98.5/32.2
	4030017350	S.CER C1005 CH 1H 020B-T	[EUR-01]	
	4030017360	S.CER C1005 CH 1H 030B-T	[EXP-01]	
	4030017360	S.CER C1005 CH 1H 030B-T	[USA-01]	
	4030017360	S.CER C1005 CH 1H 030B-T	[EXP-03]	
	4030017360	S.CER C1005 CH 1H 030B-T	[CHN-01]	
C104	4030017460	S.CER C1005 JB 1H 102K-T	B	100.8/29.9
C105	4030017730	S.CER C1005 JB 1H 471K-T	B	97.6/28.9
C106	4030017420	S.CER C1005 CH 1H 470J-T	B	91.7/48.9
C107	4030017460	S.CER C1005 JB 1H 102K-T	T	80.2/51.7
C108	4030016790	S.CER C1005 JB 1E 103K-T	B	81.3/49.2
C109	4030017460	S.CER C1005 JB 1H 102K-T	B	95.8/35.3
C110	4030017730	S.CER C1005 JB 1H 471K-T	B	98.6/35.3
C111	4030017730	S.CER C1005 JB 1H 471K-T	T	101.7/37.1
C112	4030016930	S.CER C1005 JB 1A 104K-T	T	100.8/37.1
C113	4030017540	S.CER C1005 CH 1H R75B-T	B	102.0/29.6
C114	4030017610	S.CER C1005 CH 1H 090C-T	B	98.3/26.1
C115	4030017400	S.CER C1005 CH 1H 220J-T	B	98.8/21.9
C116	4030017460	S.CER C1005 JB 1H 102K-T	B	107.5/30.0
C117	4030017730	S.CER C1005 JB 1H 471K-T	B	107.5/30.9
C118	4030017520	S.CER C1005 CH 1H 0R3B-T	B	102.8/32.0
C119	4030016790	S.CER C1005 JB 1E 103K-T	B	97.0/21.9
C120	4030017730	S.CER C1005 JB 1H 471K-T	B	97.9/21.9
C121	4030017590	S.CER C1005 CH 1H 070C-T	B	103.3/30.8
C122	4030017390	S.CER C1005 CH 1H 180J-T	B	107.5/31.8
C123	4030020040	S.CER C1005 CH 1H 200J-T	B	104.8/28.2
C124	4030017400	S.CER C1005 CH 1H 220J-T	B	105.0/20.8
C125	4030017420	S.CER C1005 CH 1H 470J-T	B	101.7/27.5
C126	4030017610	S.CER C1005 CH 1H 090C-T	B	95.6/23.7
C127	4030017410	S.CER C1005 CH 1H 240J-T	B	96.1/21.9
C128	4030017360	S.CER C1005 CH 1H 030B-T	B	99.2/27.3
C129	4030017530	S.CER C1005 CH 1H 0R5B-T	B	103.5/27.5
C131	4030017350	S.CER C1005 CH 1H 020B-T	B	106.4/27.2
C132	4030017460	S.CER C1005 JB 1H 102K-T	T	94.3/12.6
C133	4030017620	S.CER C1005 CH 1H 100C-T	B	105.4/22.7
C134	4030017620	S.CER C1005 CH 1H 100C-T	B	93.7/22.8
C135	4030016790	S.CER C1005 JB 1E 103K-T	T	78.3/21.0
C139	4030016930	S.CER C1005 JB 1A 104K-T	B	107.5/33.6
C140	4030017430	S.CER C1005 CH 1H 101J-T	B	81.2/18.9
C141	4030017460	S.CER C1005 JB 1H 102K-T	T	75.7/21.5
C143	4030017460	S.CER C1005 JB 1H 102K-T	T	78.9/22.2
C144	4030017420	S.CER C1005 CH 1H 470J-T	T	92.5/16.1
C146	4550007550	S.TAN F931V334MAABMA	T	84.7/22.9
	4550000560	S.TAN TEESVA 1V 334M8R	[EUR-01]	
	4550007550	S.TAN F931V334MAABMA	[USA-01]	
	4550007550	S.TAN F931V334MAABMA	[EXP-03]	
	4550007550	S.TAN F931V334MAABMA	[CHN-01]	
C147	4550003250	S.TAN TEESVA 1V 474M8R	T	80.5/22.9
C148	4030019560	S.CER GRM21BB31C106KE15L	T	109.7/30.5
C151	4030016930	S.CER C1005 JB 1A 104K-T	B	75.3/18.1
C152	4030017420	S.CER C1005 CH 1H 470J-T	B	77.8/18.1

[MAIN-A UNIT] (For [Low band] versions)

REF NO.	PARTS NO.	DESCRIPTION	M.	H/V LOCATION
C153	4030017420	S.CER C1005 CH 1H 470J-T	B	78.1/16.2
C154	4030017420	S.CER C1005 CH 1H 470J-T	B	76.4/16.2
C155	4030017460	S.CER C1005 JB 1H 102K-T	B	81.7/16.7
C156	4030016790	S.CER C1005 JB 1E 103K-T	B	81.2/17.9
C157	4030017620	S.CER C1005 CH 1H 100C-T	B	72.4/24.4
C160	4030016930	S.CER C1005 JB 1A 104K-T	B	74.2/21.3
C162	4030016790	S.CER C1005 JB 1E 103K-T	B	72.4/17.7
C165	4030017460	S.CER C1005 JB 1H 102K-T	B	74.1/23.5
C192	4030017360	S.CER C1005 CH 1H 030B-T	B	34.3/40.5
	4030017350	S.CER C1005 CH 1H 020B-T	[EUR-01]	
	4030017350	S.CER C1005 CH 1H 020B-T	[EXP-01]	
	4030017350	S.CER C1005 CH 1H 020B-T	[USA-01]	
	4030017350	S.CER C1005 CH 1H 020B-T	[EXP-03]	
	4030017350	S.CER C1005 CH 1H 020B-T	[CHN-01]	
C193	4030017340	S.CER C1005 CH 1H 010B-T	B	51.5/38.3
C277	4030016930	S.CER C1005 JB 1A 104K-T	B	36.0/28.4
C281	4030017770	S.CER C1005 JB 1H 332K-T	T	92.0/13.5
C282	4030016930	S.CER C1005 JB 1A 104K-T	T	44.2/28.0
C283	4030016930	S.CER C1005 JB 1A 104K-T	T	42.5/25.2
C284	4030016930	S.CER C1005 JB 1A 104K-T	T	44.2/28.9
C285	4030017580	S.CER C1005 CH 1H 060C-T	B	94.0/29.9
C286	4030017600	S.CER C1005 CH 1H 080C-T	B	36.4/26.3
C287	4030017460	S.CER C1005 JB 1H 102K-T	T	95.9/11.7
C298	4030017630	S.CER C1005 CH 1H 120J-T	T	86.3/29.4
C299	4030017570	S.CER C1005 CH 1H 040B-T	T	83.9/29.4
C300	4030017350	S.CER C1005 CH 1H 020B-T	T	85.1/30.8
C301	4030017730	S.CER C1005 JB 1H 471K-T	B	92.8/31.3
C302	4030017420	S.CER C1005 CH 1H 470J-T	B	80.1/39.2
C303	4030017730	S.CER C1005 JB 1H 471K-T	B	80.1/36.3
C305	4030017500	S.CER C1005 CH 1H 560J-T	B	64.8/24.2
C306	4030017580	S.CER C1005 CH 1H 060C-T	B	64.3/25.4
C307	4030017500	S.CER C1005 CH 1H 560J-T	B	61.3/22.7
C308	4030017360	S.CER C1005 CH 1H 030B-T	B	60.1/23.2
C309	4030016790	S.CER C1005 JB 1E 103K-T	B	67.4/21.8
C312	4030016930	S.CER C1005 JB 1A 104K-T	B	67.4/20.9
C314	4030016790	S.CER C1005 JB 1E 103K-T	T	110.5/33.8
C323	4030017620	S.CER C1005 CH 1H 100C-T	B	72.3/26.2
C328	4030017560	S.CER C1005 CH 1H 2R5B-T	B	85.4/55.8
C332	4030017530	S.CER C1005 CH 1H 0R5B-T	B	84.9/50.0
C333	4030017420	S.CER C1005 CH 1H 470J-T	B	40.4/40.7
C334	4030017590	S.CER C1005 CH 1H 070C-T	B	94.9/68.3
C335	4030017630	S.CER C1005 CH 1H 120J-T	B	93.8/68.3
C336	4030017710	S.CER C1005 CH 1H 181J-T	B	62.0/68.7
C337	4030017460	S.CER C1005 JB 1H 102K-T	T	82.7/29.2
C340	4030017710	S.CER C1005 CH 1H 181J-T	B	107.7/28.7
C342	4550007390	S.TAN F931C225MAABMA	[EUR-01]	
	4550002980	S.TAN TEESVA 1C 225M8R	[EXP-01]	
	4550007390	S.TAN F931C225MAABMA	[USA-01]	
	4550002980	S.TAN TEESVA 1C 225M8R	[EXP-03]	
	4550002980	S.TAN TEESVA 1C 225M8R	[CHN-01]	
C343	4030017460	S.CER C1005 JB 1H 102K-T	B	51.5/39.2
C344	4030017460	S.CER C1005 JB 1H 102K-T	B	54.2/68.0
C345	4030017730	S.CER C1005 JB 1H 471K-T	B	54.2/67.1
C346	4030017420	S.CER C1005 CH 1H 470J-T	B	66.0/68.7
C347	4030017460	S.CER C1005 JB 1H 102K-T	T	52.2/22.9
C348	4030017460	S.CER C1005 JB 1H 102K-T	T	59.3/20.5
C350	4030017920	S.CER C1005 JB 1A 683K-T	T	95.9/14.4
C357	4030016930	S.CER C1005 JB 1A 104K-T	T	103.5/34.7
C358	4030017340	S.CER C1005 CH 1H 010B-T	B	91.2/35.8
C366	4030017460	S.CER C1005 JB 1H 102K-T	B	97.0/64.4
C367	4030017730	S.CER C1005 JB 1H 471K-T	B	97.0/65.8
C368	4030017420	S.CER C1005 CH 1H 470J-T	B	97.0/67.3
C372	4030017730	S.CER C1005 JB 1H 471K-T	T	60.3/67.7
C376	4030017730	S.CER C1005 JB 1H 471K-T	B	88.7/49.5
C377	4030017460	S.CER C1005 JB 1H 102K-T	T	57.8/61.6
C383	4030018860	S.CER C1005 JB 0J 105K-T	T	36.4/36.2
C384	4030016930	S.CER C1005 JB 1A 104K-T	T	59.3/29.0
C385	4030016930	S.CER C1005 JB 1A 104K-T	B	54.9/28.9
C388	4030017730	S.CER C1005 JB 1H 471K-T	B	68.2/36.7
C390	4030017460	S.CER C1005 JB 1H 102K-T	B	75.0/40.6
C391	4030017420	S.CER C1005 CH 1H 470J-T	B	75.9/40.6
C392	4030017530	S.CER C1005 CH 1H 0R5B-T	B	60.3/39.2

[MAIN-A UNIT] (For [Low band] versions)

REF NO.	PARTS NO.	DESCRIPTION	M.	H/V LOCATION
C448	4030017670	S.CER C1005 CH 1H 390J-T	B	87.8/49.5
C453	4030017420	S.CER C1005 CH 1H 470J-T	B	101.3/35.3
C454	4030017460	S.CER C1005 JB 1H 102K-T	B	100.4/35.3
C457	4030017420	S.CER C1005 CH 1H 470J-T	B	54.0/37.4
C458	4030017420	S.CER C1005 CH 1H 470J-T	T	63.8/50.8
C459	4030017420	S.CER C1005 CH 1H 470J-T	T	86.1/48.4
C460	4030017420	S.CER C1005 CH 1H 470J-T	T	64.9/49.8
C463	4030017720	S.CER C1005 JB 1H 331K-T	T	54.0/26.5
C466	4030017420	S.CER C1005 CH 1H 470J-T	T	62.7/49.8
C467	4030017420	S.CER C1005 CH 1H 470J-T	T	88.4/10.4
C471	4030017420	S.CER C1005 CH 1H 470J-T	B	103.7/19.2
C494	4030018860	S.CER C1005 JB 0J 105K-T	T	37.3/36.2
C624	4030017460	S.CER C1005 JB 1H 102K-T	B	81.2/26.7
C625	4030019990	S.CER C1005 JB 1C 104K-T	B	63.3/16.4
C626	4030017430	S.CER C1005 CH 1H 101J-T	B	59.9/20.5
C627	4030018910	S.CER C1608 JB 0J 475K-T	B	57.7/19.6
C628	4030017590	S.CER C1005 CH 1H 070C-T	T	63.3/36.2
C629	4030017530	S.CER C1005 CH 1H 0R5B-T	T	66.8/29.7
C630	4030016790	S.CER C1005 JB 1E 103K-T	T	66.8/28.8
C631	4030016790	S.CER C1005 JB 1E 103K-T	T	68.6/41.6
C632	4030016790	S.CER C1005 JB 1E 103K-T	T	76.5/41.6
C633	4030016930	S.CER C1005 JB 1A 104K-T	T	81.3/43.1
C634	4030016930	S.CER C1005 JB 1A 104K-T	T	80.0/41.2
C635	4030016790	S.CER C1005 JB 1E 103K-T	T	71.5/29.7
C637	4030017600	S.CER C1005 CH 1H 080C-T	T	72.3/36.2
C638	4030017460	S.CER C1005 JB 1H 102K-T	T	83.5/42.2
C639	4030016930	S.CER C1005 JB 1A 104K-T	T	46.8/25.7
C640	4030017040	S.CER C1005 JB 1A 333K-T	B	38.8/24.4
C641	4030018890	S.CER C1005 JB 0J 224K-T	B	76.3/27.1
C642	4030018890	S.CER C1005 JB 0J 224K-T	B	77.5/27.0
C643	4030017430	S.CER C1005 CH 1H 101J-T	B	77.5/27.9
C644	4030019560	S.CER GRM21BB31C106KE15L	B	81.7/20.4
C645	4030016930	S.CER C1005 JB 1A 104K-T	B	30.0/15.7
C646	4030017460	S.CER C1005 JB 1H 102K-T	T	84.7/10.0
C647	4030016790	S.CER C1005 JB 1E 103K-T	B	59.1/27.7
C1003	4030017460	S.CER C1005 JB 1H 102K-T	T	133.3/63.5
C1005	4030018980	S.CER C1608 JB 1H 104K-T	B	100.1/11.8
C1007	4030017460	S.CER C1005 JB 1H 102K-T	T	100.1/12.1
C1008	4510009680	S.ELE EEEFK1E471P	B	110.2/52.6
C1010	4030017460	S.CER C1005 JB 1H 102K-T	B	106.5/59.0
C1011	4030016930	S.CER C1005 JB 1A 104K-T	B	93.9/12.1
C1012	4030017420	S.CER C1005 CH 1H 470J-T	T	117.5/16.6
C1014	4030017460	S.CER C1005 JB 1H 102K-T	T	116.6/27.5
C1015	4030017460	S.CER C1005 JB 1H 102K-T	T	114.9/8.0
C1017	4030017460	S.CER C1005 JB 1H 102K-T	B	122.5/64.9
C1018	4030017460	S.CER C1005 JB 1H 102K-T	T	133.3/45.0
C1019	4510009250	S.ELE EEEFK1C471P	B	130.5/34.8
C1022	4030017420	S.CER C1005 CH 1H 470J-T	B	105.5/19.0
C1023	4030017460	S.CER C1005 JB 1H 102K-T	B	113.4/58.8
C1024	4030017440	S.CER C1005 CH 1H 221J-T	B	113.4/59.7
C1025	4030017510	S.CER C1005 CH 1H 680J-T	B	113.4/60.6
C1026	4030019120	S.CER GRM188B31E105KA75D	T	115.8/49.5
C1028	4030017460	S.CER C1005 JB 1H 102K-T	B	117.4/6.1
C1029	4030017460	S.CER C1005 JB 1H 102K-T	T	114.9/12.6
C1031	4030017460	S.CER C1005 JB 1H 102K-T	T	115.0/16.9
C1032	4030016930	S.CER C1005 JB 1A 104K-T	B	123.6/16.6
C1033	4510009680	S.ELE EEEFK1E471P	B	120.0/29.1
C1034	4030018860	S.CER C1005 JB 0J 105K-T	B	131.6/16.6
C1035	4030016790	S.CER C1005 JB 1E 103K-T	B	131.6/18.7
C1036	4030018980	S.CER C1608 JB 1H 104K-T	T	128.4/46.9
C1037	4030019560	S.CER GRM21BB31C106KE15L	B	129.4/43.4
C1038	4030011600	S.CER C1608 JB 1E 104K-T	T	115.0/48.7
C1039	4510009680	S.ELE EEEFK1E471P	B	117.0/41.7
C1040	4030019560	S.CER GRM21BB31C106KE15L	B	116.7/22.2
C1042	4030016930	S.CER C1005 JB 1A 104K-T	B	118.1/22.4
C1043	4030016930	S.CER C1005 JB 1A 104K-T	T	114.9/16.0
C1045	4030017460	S.CER C1005 JB 1H 102K-T	T	114.9/14.2
C1046	4030018860	S.CER C1005 JB 0J 105K-T	T	114.9/15.1
C1048	4030018900	S.CER C1005 JB 0J 474K-T	B	126.7/18.6
C1050	4030018860	S.CER C1005 JB 0J 105K-T	B	125.2/16.6
C1051	4030017460	S.CER C1005 JB 1H 102K-T	B	122.1/48.2
C1052	4030016930	S.CER C1005 JB 1A 104K-T	T	127.8/40.1
C1053	4030019560	S.CER GRM21BB31C106KE15L	T	126.7/44.5
C1056	4030018860	S.CER C1005 JB 0J 105K-T	T	111.2/11.7
C1057	4030016930	S.CER C1005 JB 1A 104K-T	B	118.7/17.1
C1058	4030019560	S.CER GRM21BB31C106KE15L	T	105.5/44.4
C1059	4030017460	S.CER C1005 JB 1H 102K-T	T	107.7/46.3
C1060	4030017460	S.CER C1005 JB 1H 102K-T	B	126.2/39.8
C1061	4030017460	S.CER C1005 JB 1H 102K-T	T	107.7/37.4
C1062	4030017460	S.CER C1005 JB 1H 102K-T	B	120.7/22.9
C1063	4030019560	S.CER GRM21BB31C106KE15L	B	126.9/22.2
C1064	4030019560	S.CER GRM21BB31C106KE15L	B	121.6/36.0
C1065	4030017460	S.CER C1005 JB 1H 102K-T	B	120.2/35.6
C1066	4030018860	S.CER C1005 JB 0J 105K-T	B	125.6/38.1
C1070	4030017440	S.CER C1005 CH 1H 221J-T	B	120.4/16.2
C1071	4030016930	S.CER C1005 JB 1A 104K-T	B	120.4/10.8
C1074	4030017460	S.CER C1005 JB 1H 102K-T	B	73.9/10.4
C1075	4030017460	S.CER C1005 JB 1H 102K-T	B	70.7/14.4
C1076	4030017460	S.CER C1005 JB 1H 102K-T	B	69.7/14.4
C1077	4030017460	S.CER C1005 JB 1H 102K-T	B	68.8/14.4
C1080	4030016790	S.CER C1005 JB 1E 103K-T	B	51.1/15.3
C1081	4030016930	S.CER C1005 JB 1A 104K-T	B	117.2/15.2
C1082	4030016930	S.CER C1005 JB 1A 104K-T	B	114.8/14.6
C1083	4030017460	S.CER C1005 JB 1H 102K-T	T	37.6/19.3
C1084	4030017710	S.CER C1005 CH 1H 181J-T	B	41.9/20.8
C1085	4030017460	S.CER C1005 JB 1H 102K-T	T	76.3/14.6
C1092	4030016930	S.CER C1005 JB 1A 104K-T	T	75.8/14.4
C1095	4030016930	S.CER C1005 JB 1A 104K-T	T	38.5/19.3
C1096	4030018860	S.CER C1005 JB 0J 105K-T	T	51.7/18.5
C1097	4030018240	S.CER C1005 JB 1H 562K-T	B	50.8/17.8
C1098	4030018860	S.CER C1005 JB 0J 105K-T	T	54.5/16.3
C1099	4030018860	S.CER C1005 JB 0J 105K-T	B	45.2/20.8
C1100	4030017460	S.CER C1005 JB 1H 102K-T	B	75.8/9.1

[EUR-01] only

[MAIN-A UNIT] (For [Low band] versions)

REF NO.	PARTS NO.	DESCRIPTION	M.	H/V LOCATION
C1101	4030017420	S.CER C1005 CH 1H 470J-T	T	78.2/8.0
	4030016930	S.CER C1005 JB 1A 104K-T	[EXP-01]	
	4030016930	S.CER C1005 JB 1A 104K-T	[USA-01]	
	4030016930	S.CER C1005 JB 1A 104K-T	[EXP-03]	
	4030016930	S.CER C1005 JB 1A 104K-T	[CHN-01]	
C1102	4030017420	S.CER C1005 CH 1H 470J-T	B	71.6/6.6
C1106	4030016930	S.CER C1005 JB 1A 104K-T	T	36.3/20.6
C1107	4030017440	S.CER C1005 CH 1H 221J-T	B	33.1/15.2
C1108	4030017450	S.CER C1005 JB 1H 271K-T	B	39.2/13.5
C1109	4030018860	S.CER C1005 JB 0J 105K-T	T	42.5/18.0
C1110	4030018860	S.CER C1005 JB 0J 105K-T	T	42.5/20.4
C1111	4030018860	S.CER C1005 JB 0J 105K-T	T	46.6/19.1
C1112	4030016930	S.CER C1005 JB 1A 104K-T	B	45.7/19.1
C1119	4030017420	S.CER C1005 CH 1H 470J-T	B	65.2/6.9
C1127	4030017660	S.CER C1005 CH 1H 330J-T	B	36.6/21.2
C1128	4030016930	S.CER C1005 JB 1A 104K-T	B	31.3/13.6
C1129	4030016930	S.CER C1005 JB 1A 104K-T	B	32.2/16.9
C1130	4030017900	S.CER C1005 JB 1E 123K-T	T	37.4/13.5
C1131	4550008240	S.TAN F930G476MAA	[EUR-01]	
	4550006970	S.TAN TEESVA OG 476M8R	[EXP-01]	
	4550008240	S.TAN F930G476MAA	[USA-01]	
	4550008240	S.TAN F930G476MAA	[EXP-03]	
	4550008240	S.TAN F930G476MAA	[CHN-01]	
C1132	4030017460	S.CER C1005 JB 1H 102K-T	T	51.8/13.0
C1133	4030016790	S.CER C1005 JB 1E 103K-T	T	78.2/5.7
C1135	4030017460	S.CER C1005 JB 1H 102K-T	T	73.9/16.8
C1136	4030016930	S.CER C1005 JB 1A 104K-T	T	71.6/15.5
C1137	4030016780	S.CER C1005 JB 1E 153K-T	B	40.1/20.8
	4030016970	S.CER C1005 JB 1E 223K-T	[EXP-01]	
	4030016970	S.CER C1005 JB 1E 223K-T	[USA-01]	
	4030016970	S.CER C1005 JB 1E 223K-T	[EXP-03]	
	4030016970	S.CER C1005 JB 1E 223K-T	[CHN-01]	
C1138	4030017460	S.CER C1005 JB 1H 102K-T	T	37.7/15.7
C1139	4030017920	S.CER C1005 JB 1A 683K-T	T	54.5/17.2
C1140	4030017040	S.CER C1005 JB 1A 333K-T	B	52.0/18.3
C1141	4030016790	S.CER C1005 JB 1E 103K-T	B	42.4/17.3
C1142	4030016930	S.CER C1005 JB 1A 104K-T	B	117.6/11.8
C1143	4030018980	S.CER C1608 JB 1H 104K-T	B	93.8/9.4
C1144	4030016930	S.CER C1005 JB 1A 104K-T	B	41.7/15.1
C1145	4030018980	S.CER C1005 JB 1E 822K-T	B	42.8/20.8
C2001	4050000240	S.FEE NFM18PC104R1C3D	T	39.3/10.9
C2002	4030016930	S.CER C1005 JB 1A 104K-T	B	34.9/5.4
C2004	4550007730	S.TAN TEESVJ 0J 106M8R	B	35.3/7.2
C2007	4030018910	S.CER C1608 JB 0J 475K-T	B	18.4/10.4
C2008	4030016930	S.CER C1005 JB 1A 104K-T	B	16.1/8.9
C2009	4050000240	S.FEE NFM18PC104R1C3D	B	28.0/5.9
C2010	4050000240	S.FEE NFM18PC104R1C3D	B	12.3/5.5
C2011	4030019640	S.CER C1608 JB 0J 106M-T	T	33.0/6.9
C2012	4030016930	S.CER C1005 JB 1A 104K-T	B	26.4/5.8
C2013	4550007730	S.TAN TEESVJ 0J 106M8R	B	25.0/6.2
C2014	4030016930	S.CER C1005 JB 1A 104K-T	T	31.7/6.6
C2015	4030016930	S.CER C1005 JB 1A 104K-T	B	10.1/6.4
C2016	4550007720	S.TAN TEESVP OG 476M8R	T	26.7/7.1
C2017	4550007730	S.TAN TEESVJ 0J 106M8R	B	17.2/9.2
C2018	4030016930	S.CER C1005 JB 1A 104K-T	B	9.2/6.4
C2019	4030016790	S.CER C1005 JB 1E 103K-T	B	14.8/19.3
C2021	4030018910	S.CER C1608 JB 0J 475K-T	B	16.0/21.6
C2022	4030018910	S.CER C1608 JB 0J 475K-T	B	13.5/14.5
C2023	4030016790	S.CER C1005 JB 1E 103K-T	B	23.1/14.3
C2024	4030018860	S.CER C1005 JB 0J 105K-T	B	21.2/14.1
C2025	4030017420	S.CER C1005 CH 1H 470J-T	B	20.8/11.1
C2026	4030017460	S.CER C1005 JB 1H 102K-T	B	20.8/10.2
C2027	4030018910	S.CER C1608 JB 0J 475K-T	B	10.9/10.0
C2028	4030018860	S.CER C1005 JB 0J 105K-T	T	11.5/10.2
C2031	4030018860	S.CER C1005 JB 0J 105K-T	T	20.9/11.3
C2032	4030016930	S.CER C1005 JB 1A 104K-T	T	13.1/11.7
C2033	4030018860	S.CER C1005 JB 0J 105K-T	B	15.1/17.7
C2034	4030016930	S.CER C1005 JB 1A 104K-T	T	11.9/7.9
C2035	4030018910	S.CER C1608 JB 0J 475K-T	T	10.2/8.2
C2036	4030018860	S.CER C1005 JB 0J 105K-T	B	21.1/20.9
C2038	4030016790	S.CER C1005 JB 1E 103K-T	B	16.4/25.3
C2039	4030017430	S.CER C1		

[MAIN-A UNIT] (For [Low band] versions)

REF NO.	PARTS NO.	DESCRIPTION	M.	H/V LOCATION
C2075	4030017430	S.CER C1005 CH 1H 101J-T	T	18.3/15.9
C2076	4030016930	S.CER C1005 JB 1A 104K-T	B	7.7/27.1
C2077	4030019610	S.CER GRM155B31A105KE15D	B	41.2/6.1
C2078	4030017460	S.CER C1005 JB 1H 102K-T	B	39.8/8.9
C2079	4030017460	S.CER C1005 JB 1H 102K-T	B	38.2/8.9
C2080	4030016790	S.CER C1005 JB 1E 103K-T	B	36.7/5.4
C2081	4550007730	S.TAN TEESVJ OJ 106M8R	B	36.5/7.2
C2082	4550007720	S.TAN TEESVJ OJ 476M8R	T	28.5/7.0
[EUR-01] only				
J1001	6510014961	S.CON B2B-ZR-SM4-TF(LF)(SN)	T	130.5/27.3
J1002	6450000140	S.CON HSJ0807-01-010	T	
J1003	6510022891	S.CON B13B-ZR-SM4-TF(LF)(SN)	T	120.0/17.2
J1004	6510027960	S.CON 04-6294-040-000-800	T	67.5/10.6
S1001	2260003180	S.SWI MINISMDC050F-2 CN	T	114.1/33.8
W1	7030012290	JUM RDS2T0R0		
W2	8900011863	CAB OPC-1195C <TJM>		
EP1	6910018460	S.BEA MMZ1005Y102C-T	B	107.5/32.7
EP4	6910010280	BEA HF70BB9.5X10.4X4.9		
EP5	6910010280	BEA HF70BB9.5X10.4X4.9		
EP7	6910018460	S.BEA MMZ1005Y102C-T	B	74.2/19.4
EP8	6910018460	S.BEA MMZ1005Y102C-T	B	80.8/16.7
EP13	6910018460	S.BEA MMZ1005Y102C-T	B	100.1/25.3
EP14	6910011560	BEA HF70BB4.5X5X1.6		
EP15	6910011560	BEA HF70BB4.5X5X1.6		
EP2001	6910016330	S.BEA MMZ1005S 601CT-S	B	22.8/5.3
EP2003	6910016330	S.BEA MMZ1005S 601CT-S	T	9.1/7.0
EP2004	6910016330	S.BEA MMZ1005S 601CT-S	T	32.7/9.0
EP2005	6910016330	S.BEA MMZ1005S 601CT-S	B	24.6/23.8
EP2007	6910016330	S.BEA MMZ1005S 601CT-S	T	10.8/6.2

[MAIN-B UNIT] (For [High band] versions)

REF NO.	PARTS NO.	DESCRIPTION	M.	H/V LOCATION
IC2	1110002751	S.IC TA75S01F(TE85RF)	T	60.0/54.9
IC3	1150002410	IC RA60H4452M1-121 [USA-02]		
	1150002410	IC RA60H4452M1-121 [EXP-04]		
IC4	1110007320	S.IC NJM2591V-TE1-#ZZZB	T	57.8/24.7
IC5	1110006230	S.IC NJM2711F-TE1-#ZZZB	B	38.8/27.0
IC6	1110002751	S.IC TA75S01F(TE85RF)	B	59.9/17.4
IC7	1130011741	S.IC TC7W66FK(TE85LF)	B	85.8/12.3
IC8	1130015271	S.IC AK1541P4-L	B	78.2/23.7
IC1001	1180003660	S.REG XC6408EN22PR-G	B	96.9/10.8
IC1002	1180003500	S.REG NJM7808DL1A-TE1-#FZZB	T	123.3/45.7
IC1004	1110002751	S.IC TA75S01F(TE85RF)	B	119.7/13.0
IC1005	1110007630	S.IC NJM2783V-TE1-#ZZZH	T	47.4/18.9
IC1006	1110007290	S.IC AK2330P-L	B	53.7/11.5
IC1007	1110005320	S.IC NJM13403V-TE1-#ZZZB	B	37.4/17.0
IC1008	1130009981	S.IC TC7W53FK(TE85LF)	T	40.3/19.7
IC1009	1110003091	IC LA4425A-E		
IC2001	1180003680	S.REG TPS62204DBVR	B	32.4/6.5
IC2002	1190002900	S.IC ADS7886SDCKR	B	14.4/9.3
IC2006	1110007770	S.IC PCM3008T/2K	T	16.3/8.3
IC2007	1140013290	S.IC TMS320VC5509AZHH	T	18.0/18.4
IC2008	1130015620	S.IC EN25Q40-100GIP <MSK>	B	12.5/25.3
IC2009	1110006230	S.IC NJM2711F-TE1-#ZZZB	B	26.7/12.7
IC2010	1180003600	S.REG NJM2871BF05-TE1-#ZZZB	B	39.0/6.8
Q1	1590004090	S.TRA LDT114YET1G <SLVJ>	B	47.2/27.1
Q2	1580000731	S.FET 3SK293(TE85LF)	B	41.5/38.7
Q3	1560000541	S.FET 2SK880-Y(T5R1COMF)	T	77.2/24.5
Q4	1530002851	S.TRA 2SC4116-BL(TE85RF)	B	67.9/25.4
Q5	1530002851	S.TRA 2SC4116-BL(TE85RF)	T	44.9/25.3
Q6	1590004090	S.TRA LDT114YET1G <SLVJ>	T	62.2/52.2
Q7	1560000841	S.FET 2SK1829(TE85RF)	T	33.7/39.7
Q8	1530002680	S.TRA 2SC3357-T1	B	90.4/52.8
Q9	1560001360	S.FET 2SK3019 TR	T	52.2/26.3
Q10	1530003311	S.TRA 2SC5107-O(TE85RF)	B	92.8/33.1
Q11	1530003311	S.TRA 2SC5107-O(TE85RF)	B	100.5/31.7
Q12	1530004110	S.TRA MT3S37T(TE85LF)	B	97.6/30.4
Q13	1590004090	S.TRA LDT114YET1G <SLVJ>	B	57.6/27.2
Q14	1530003311	S.TRA 2SC5107-O(TE85RF)	T	64.8/24.9
Q15	1590004500	S.TRA DMC561040R	T	101.0/34.4
Q17	1530002851	S.TRA 2SC4116-BL(TE85RF)	T	107.7/33.4
Q18	1590004090	S.TRA LDT114YET1G <SLVJ>	T	81.5/40.8
Q19	1580000731	S.FET 3SK293(TE85LF)	B	71.4/38.4
Q20	1530002851	S.TRA 2SC4116-BL(TE85RF) [USA-02]	T	60.0/49.8
	1530002851	S.TRA 2SC4116-BL(TE85RF) [EXP-04]		
Q21	1590004090	S.TRA LDT114YET1G <SLVJ>	T	49.5/24.8
Q23	1530002921	S.TRA 2SC4226-T1 Y25 (R25)	B	105.2/30.9
Q24	1530002921	S.TRA 2SC4226-T1 Y25 (R25)	B	98.3/24.2
Q25	1530003260	S.TRA 2SC5006-T1	B	84.9/51.5
Q1001	1590004090	S.TRA LDT114YET1G <SLVJ>	T	110.6/44.1
Q1003	1550000190	S.FET 2SJ506STR-E	T	115.3/45.4
Q1004	1590004090	S.TRA LDT114YET1G <SLVJ>	T	114.0/26.7
Q1005	1590004090	S.TRA LDT114YET1G <SLVJ>	T	114.0/24.7
Q1007	1590004090	S.TRA LDT114YET1G <SLVJ>	B	116.3/8.1
Q1008	1590000990	S.TRA DTC363EK T146	B	128.9/17.8
Q1009	1590001451	S.FET 2SJ144-GR (TE85RF)	B	113.8/11.1
Q1010	1590004090	S.TRA LDT114YET1G <SLVJ>	B	116.1/10.9
Q1011	1540000550	S.TRA 2SD1664 T100Q	B	125.1/47.6
Q1012	1590004090	S.TRA LDT114YET1G <SLVJ>	B	130.9/20.7
Q1013	1510000920	S.TRA 2SA1577 T106 Q	T	107.7/44.3
Q1014	1520000460	S.TRA 2SB1132 T100 R	B	123.5/21.1
Q1015	1590004590	S.TRA DMC506010R	B	118.9/20.4
Q1016	1590004090	S.TRA LDT114YET1G <SLVJ>	T	107.8/39.2
Q1017	1520000460	S.TRA 2SB1132 T100 R	T	120.1/35.2
Q1018	1590004090	S.TRA LDT114YET1G <SLVJ>	B	126.4/43.3
Q1019	1590004590	S.TRA DMC506010R	B	123.8/35.8
Q1020	1590004090	S.TRA LDT114YET1G <SLVJ>	T	46.2/22.5
Q1021	1590004090	S.TRA LDT114YET1G <SLVJ>	B	126.4/41.3
Q2001	1590004040	S.TRA LDTA123YET1G <SLVJ>	B	26.9/26.6
D2	1750001910	S.DIO HVD144AKRF-E	B	52.6/28.5
D3	1750001910	S.DIO HVD144AKRF-E	B	52.6/27.3
D4	1750000711	S.VAR HVC350BTRF-E	B	36.0/40.2
D5	1750002060	S.DIO RN752TE-21	T	26.5/53.3
D7	1750001910	S.DIO HVD144AKRF-E	B	25.3/45.3
D8	1750001910	S.DIO HVD144AKRF-E	B	43.4/27.3
D9	1750001910	S.DIO HVD144AKRF-E	B	43.4/28.6
D10	1750000711	S.VAR HVC350BTRF-E	B	55.5/39.9
D11	1750001820	S.DIO LRB706F-40T1G <SLVJ>	B	8.2/49.9
D12	1750001820	S.DIO LRB706F-40T1G <SLVJ>	B	22.8/49.9
D13	1750001910	S.DIO HVD144AKRF-E	T	68.3/28.1
D14	1750001910	S.DIO HVD144AKRF-E	T	69.5/28.1
D15	1790001261	S.DIO MA2S077GOL	B	82.2/39.2
D16	1750000711	S.VAR HVC350BTRF-E	B	106.7/20.3
D17	1750001910	S.DIO HVD144AKRF-E	T	70.6/41.6
D18	1750001910	S.DIO HVD144AKRF-E	T	74.5/41.6
D19	1750000711	S.VAR HVC350BTRF-E	B	61.9/39.9
D20	1750000711	S.VAR HVC350BTRF-E	B	28.0/40.2
D21	1750000711	S.VAR HVC350BTRF-E	B	36.0/41.6
D22	1750000711	S.VAR HVC350BTRF-E	B	28.0/41.6
D23	1750000711	S.VAR HVC350BTRF-E	B	52.8/42.6
D24	1750002060	S.DIO RN752TE-21	T	35.1/56.7
D25	1750000581	S.DIO 1SV307(TPH3F)	B	83.5/42.1
D26	1750001650	S.VAR 1SV309(TPH3F)	B	101.8/25.9
D29	1750001820	S.DIO LRB706F-40T1G <SLVJ>	B	19.2/49.9
D33	1750000711	S.VAR HVC350BTRF-E	B	97.8/20.5
D62	1750000711	S.VAR HVC350BTRF-E	B	91.7/22.8
D64	1750000711	S.VAR HVC350BTRF-E	B	106.7/21.5
D66	1750000370	S.DIO DA221 TL	T	33.7/37.1
D67	1750002170	S.DIO DB2S31400L	T	31.8/39.7
D1002	1790000700	DIO DSA3A1		
D1003	1750000370	S.DIO DA221 TL	B	114.0/8.2
D1004	1750000370	S.DIO DA221 TL	B	114.1/6.1
D1005	1750000370	S.DIO DA221 TL	T	113.2/7.4

M.=Mounted side (T: Mounted on the Top side, B: Mounted on the Bottom side)
S.=Surface mount

[MAIN-B UNIT] (For [High band] versions)

REF NO.	PARTS NO.	DESCRIPTION	M.	H/V LOCATION
D1006	1750000370	S.DIO DA221 TL	T	113.0/10.3
D1007	1750001810	S.DIO L1SS400T1G <SLVJ>	B	129.0/20.7
D1008	1750000370	S.DIO DA221 TL	B	124.0/43.3
D2002	1750002170	S.DIO DB2S31400L	T	24.9/18.0
D2003	1750002170	S.DIO DB2S31400L	B	10.7/30.5
D2004	1750002170	S.DIO DB2S31400L	B	22.1/21.4
D2005	1750002170	S.DIO DB2S31400L	B	17.5/26.3
D2006	1750002170	S.DIO DB2S31400L	T	12.0/25.3
D2008	1750002020	S.DIO DA2S10100L	T	100.3/6.5
F11	2020002570	CER LTM450HW <JJE>		
F12	2020002410	CER LTM450FW <JJE>		
F13	2020002610	S.CER LTUCG450G <JJE>	T	36.3/28.0
F14	2030000870	S.MON MFT46.3P3 46.350 MHz (FL-442)	T	66.9/34.9
F15	2010002760	S.XTA MFT46.3J 46.350 MHz (FL-448)	T	75.8/34.9
F16	2040001440	S.LC NFE31PT152Z1E9L (NFM60R20T152)	B	97.7/62.2
F17	2040001440	S.LC NFE31PT152Z1E9L (NFM60R20T152)	B	97.7/58.9
F18	2040001440	S.LC NFE31PT152Z1E9L (NFM60R20T152) [USA-02]	B	97.7/55.4
	2040001440	S.LC NFE31PT152Z1E9L (NFM60R20T152) [EXP-04]		
X1	6070000300	S.DIS JTBM450CX24 <JJE>	B	51.4/22.5
X2	6050013000	S.XTA CR-892 TTS14VSB-A8 15.3 MHz	B	71.5/21.0
X2001	6050013170	S.XTA CR-914 TTS18VSE-A11 12.288 MHz	B	27.0/18.2
L1	6200010150	S.COI AS080340-15N	B	8.4/62.7
L2	6200010150	S.COI AS080340-15N	B	12.9/55.5
L3	6200010150	S.COI AS080340-15N	B	20.7/55.5
L4	6200013100	S.COI 0.45-1.5-STL 18.3N <COMO>	T	31.1/50.5
L5	6200010420	S.COI FHW1210HC 1R0JGT <JJE>	T	38.5/58.4
L6	6200010150	S.COI AS080340-15N	B	27.3/55.5
L7	6200012870	S.COI 0.30-1.4-5TR 23.5N <COMO>	B	28.8/37.8
L8	6200012870	S.COI 0.30-1.4-5TR 23.5N <COMO>	B	35.2/37.8
L9	6200012170	S.COI MLG1608S R18J-T	B	65.8/24.7
L10	6200011460	S.COI C2520C-10NG-A	B	49.0/39.8
L11	6200011460	S.COI C2520C-10NG-A	B	57.8/40.5
L12	6200012170	S.COI MLG1608S R18J-T	B	62.3/22.4
L13	6200007901	S.COI ELJRF 22NJFB	T	85.1/29.9
L16	6200010150	S.COI AS080340-15N	B	38.2/65.2
L18	6200005681	S.COI ELJRE 15NGFA	B	88.1/58.9
L19	6200005701	S.COI ELJRE 22NGFA	B	89.9/56.0
L20	6200010090	S.COI ELJND R82JF	B	68.9/40.9
L21	6200005701	S.COI ELJRE 22NGFA	B	90.8/33.1
L22	6200005701	S.COI ELJRE 22NGFA	B	99.5/33.8
L23	6200005661	S.COI ELJRE 10NGFA	B	84.9/53.2
L27	6200007370	S.COI ELJFC R82K-F	B	103.2/21.4
L28	6200011860	S.COI LQW18ANR47G00D	T	94.7/17.3
L36	6200006991	S.COI ELJRE 56NGFA	B	73.5/38.5
L37	6200006981	S.COI ELJRE R10GFA	T	82.6/62.9
L38	6200014300	S.COI C36-4.7J <COMO>	B	106.2/24.9
L39	6200013710	S.COI C36-8NH <COMO>	B	92.9/20.2
L41	6200005711	S.COI ELJRE 27NGFA	B	95.8/29.8
L53	6200005721	S.COI ELJRE 33NGFA	B	78.0/39.2
L54	6200007370	S.COI ELJFC R82K-F	T	100.0/30.4
L55	6200002851	S.COI NLV25T-R82J	B	103.7/38.8
L56	6200011460	S.COI C2520C-10NG-A	B	64.2/40.5
L57	6200011860	S.COI LQW18ANR47G00D	B	92.6/24.0
L58	6200011860	S.COI LQW18ANR47G00D	B	105.9/19.7
L1001	6200004660	S.COI MLF1608A 1R8K-T	T	79.8/13.3
L2001	6200014160	S.COI VLCF4028T-100M1R0-2	T	35.9/7.6
L2002	6200007830	S.COI ELJFC 4R7K-F	B	31.2/11.2
R1	7030000620	S.RES MCR10EZHZ 100 K (104)	B	12.3/65.5
R4	7030003560	S.RES ERJ3GEYJ 103 V (10K)	B	16.4/50.6
R5	7030005220	S.RES ERJ2GEJ 223 X (22K)	B	11.2/49.6
R6	7030005220	S.RES ERJ2GEJ 223 X (22K)	B	19.8/48.1
R7	7030003560	S.RES ERJ3GEYJ 103 V (10K)	B	8.2/53.2
R8	7030006070	S.RES ERJ12YJ101U (100)	B	45.7/51.9
R9	7030003560	S.RES ERJ3GEYJ 103 V (10K)	B	25.6/50.6
R10	7030005220	S.RES ERJ2GEJ 223 X (22K)	B	22.2/48.1
R11	7030005050	S.RES ERJ2GEJ 103 X (10K)	B	31.5/40.5
R12	7030004980	S.RES ERJ2GEJ 101 X (100)	B	39.2/39.5
R13	7030005050	S.RES ERJ2GEJ 103 X (10K)	B	32.5/40.5
R14	7030005050	S.RES ERJ2GEJ 103 X (10K)	B	32.5/38.8
R15	7030005700	S.RES ERJ2GEJ 274 X (270K)	B	39.2/38.6
R16	7030004990	S.RES ERJ2GEJ 221 X (220)	B	39.5/40.7
R17	7030005530	S.RES ERJ2GEJ 100 X (10)	B	51.5/40.2
R18	7030005050	S.RES ERJ2GEJ 103 X (10K)	B	60.8/40.5
R19	7030005090	S.RES ERJ2GEJ 104 X (100K)	B	39.2/36.8
R20	7030005120	S.RES ERJ2GEJ 102 X (1K)	B	52.8/38.6
R21	7030005050	S.RES ERJ2GEJ 103 X (10K)	B	54.1/40.2
R22	7030005050	S.RES ERJ2GEJ 103 X (10K)	B	56.2/37.4
R23	7030005050	S.RES ERJ2GEJ 103 X (10K)	B	54.1/41.2
R29	7030005570	S.RES ERJ2GEJ 820 X (82)	B	74.0/40.6
R30	7030007300	S.RES ERJ2GEJ 332 X (3.3K)	B	71.3/41.2
R31	7030004980	S.RES ERJ2GEJ 101 X (100)	B	66.9/37.4
R33	7030005600	S.RES ERJ2GEJ 273 X (27K)	T	71.9/42.7
R34	7030005110	S.RES ERJ2GEJ 224 X (220K)	T	64.9/23.1
R35	7030005530	S.RES ERJ2GEJ 100 X (10)	T	64.9/22.2
R36	7030005030	S.RES ERJ2GEJ 152 X (1.5K)	T	56.2/21.7
R37	7030008400	S.RES ERJ2GEJ 182 X (1.8K)	T	56.6/25.5
R38	7030005090	S.RES ERJ2GEJ 104 X (100K)	T	61.7/17.8
R39	7030004970	S.RES ERJ2GEJ 470 X (47)	B	58.4/22.2
R40	7030005030	S.RES ERJ2GEJ 152 X (1.5K)	B	58.4/23.2
R41	7030010040	S.RES ERJ2GEJ-JPW	T	60.8/17.8
R42	7030005070	S.RES ERJ2GEJ 683 X (68K)	T	51.0/24.3
R43	7030005000	S.RES ERJ2GEJ 471 X (470)	T	55.6/19.9
R44	7030005310	S.RES ERJ2GEJ 124 X (120K)	T	54.0/24.7
R45	7030005310	S.RES ERJ2GEJ 124 X (120K)	T	52.2/24.7
R46	7030008410	S.RES ERJ2GEJ 392 X (3.9K)	T	54.0/22.9
R48	7030008300	S.RES ERJ2GEJ 184 X (180K) [USA-02]	T	56.8/53.2
	7030008300	S.RES ERJ2GEJ 184 X (180K) [EXP-04]		
R49	7520000241	S.POS PRF18BC471QB5RB [USA-02]	T	47.3/53.2
	7520000241	S.POS PRF18BC471QB5RB [EXP-04]		
R50	7030005050	S.RES ERJ2GEJ 103 X (10K)	B	80.1/37.9
R51	7030005080	S.RES ERJ2GEJ 823 X (82K) [USA-02]	T	61.8/49.8
	7030005080	S.RES ERJ2GEJ 823 X (82K) [EXP-04]		
R52	7030005070	S.RES ERJ2GEJ 683 X (68K)	T	58.7/52.1
R53	7030004990	S.RES ERJ2GEJ 221 X (220)	T	57.8/53.2
R54	7030005220	S.RES ERJ2GEJ 223 X (22K)	B	58.8/55.7
R56	7030005110	S.RES ERJ2GEJ 224 X (220K)	T	63.3/55.0
R57	7030005050	S.RES ERJ2GEJ 103 X (10K)	B	58.8/54.8
R58	7030005570	S.RES ERJ2GEJ 820 X (82)	B	64.2/55.0
R59	7030007350	S.RES ERJ2GEJ 393 X (39K)	T	59.7/52.1
R61	7030004970	S.RES ERJ2GEJ 470 X (47)	B	90.5/49.5
R62	7030008290	S.RES ERJ2GEJ 183 X (18K)	B	89.6/49.5
R66	7030005090	S.RES ERJ2GEJ 104 X (100K)	B	84.9/49.1
R67	7030004980	S.RES ERJ2GEJ 101 X (100)	B	83.0/47.3
R68	7030005050	S.RES ERJ2GEJ 103 X (10K)	B	82.6/48.7
R69	7030005040	S.RES ERJ2GEJ 472 X (4.7K)	B	84.0/38.0
R70	7030004990	S.RES ERJ2GEJ 221 X (220)	B	92.8/35.8
R71	7030007260	S.RES ERJ2GEJ 330 X (33)	B	95.3/33.8
R72	7030004980	S.RES ERJ2GEJ 101 X (100)	B	86.5/49.1
R73	7030004980	S.RES ERJ2GEJ 101 X (100)	B	99.5/35.3
R74	7030005080	S.RES ERJ2GEJ 823 X (82K)	B	101.3/33.7
R75	7030005720	S.RES ERJ2GEJ 563 X (56K)	B	97.6/32.2
R76	7030005030	S.RES ERJ2GEJ 152 X (1.5K)	B	96.7/32.2
R77	7030005120	S.RES ERJ2GEJ 102 X (1K)	T	105.6/36.0
R78	7030009270	S.RES ERJ2GEJ 821 X (820)	T	102.5/32.5
R79	7030006020	S.RES RR0510P-682-D (6.8K)	B	96.5/23.7
R80	7030009270	S.RES ERJ2GEJ 821 X (820)	T	100.0/32.5
R83	7030006020	S.RES RR0510P-682-D (6.8K)	B	106.4/29.1
R84	7030006020	S.RES RR0510P-682-D (6.8K)	B	106.4/28.2
R85	7030006020	S.RES RR0510P-682-D (6.8K)	B	95.6/25.3
R86	7030005110	S.RES ERJ2GEJ 224 X (220K)	B	102.6/24.4
R87	7030005530	S.RES ERJ2GEJ 100 X (10)	B	102.6/27.5
R89	7030005050	S.RES ERJ2GEJ 103 X (10K)	T	79.0/25.0
R90	7030005170	S.RES ERJ2GEJ 474 X (470K)	T	95.9/15.3
R92	7030005100	S.RES ERJ2GEJ 154 X (150K)	T	94.3/14.4
R93	7030005600	S.RES ERJ2GEJ 273 X (27K)	B	81.3/25.8
R95	7030005710	S.RES ERJ2GEJ 121 X (120)	B	83.8/24.5
R96	7030008400	S.RES ERJ2GEJ 182 X (1.8K)	B	83.8/23.5
R97	7030010040	S.RES ERJ2GEJ-JPW	B	82.2/24.5
R98	7030007290	S.RES ERJ2GEJ 222 X (22K)	T	109.5/33.8
R100	7030005240	S.RES ERJ2GEJ 473 X (47K)	T	76.1/20.3
R101	7030004980	S.RES ERJ2GEJ 101 X (100)	T	77.9/22.2
R123	7030005530	S.RES ERJ2GEJ 100 X (10)	T	68.2/40.4
R125	7030008370	S.RES ERJ2GEJ 561 X (560)	T	65.6/29.2
R171	7030004980	S.RES ERJ2GEJ 101 X (100)	T	45.5/28.6
R172	7030008300	S.RES ERJ2GEJ 184 X (180K)	T	44.2/27.1
R173	7030005120	S.RES ERJ2GEJ 102 X (1K)	T	42.9/26.4
R174	7030005290	S.RES ERJ2GEJ 682 X (6.8K)	T	42.0/28.8
R175	7030009290	S.RES ERJ2GEJ 562 X (5.6K)	T	41.6/27.6
R176	7030005030	S.RES ERJ2GEJ 152 X (1.5K)	T	42.0/26.4
R178	7030004970	S.RES ERJ2GEJ 470 X (47)	B	39.8/24.4
R211	7030004970	S.RES ERJ2GEJ 470 X (47)	T	82.7/23.8
R212	7030010040	S.RES ERJ2GEJ-JPW	T	82.6/60.4
R234	7030005070	S.RES ERJ2GEJ 683 X (68K)	B	92.8/34.9
R235	7030004980	S.RES ERJ2GEJ 101 X (100)	B	81.0/37.9
R236	7030007570	S.RES ERJ2GEJ 122 X (1.2K)	B	67.4/22.7
R237	7030007060	S.RES ERJ2GEJ 684X (680K)	B	67.4/23.6
R289	7030005240	S.RES ERJ2GEJ 473 X (47K)	T	95.9/12.6
R290	7030005010	S.RES ERJ2GEJ 681 X (680)	T	63.2/23.3
R291	7030005090	S.RES ERJ2GEJ 104 X (100K)	T	94.3/13.5
R293	7030006610	S.RES ERJ2GEJ 394 X (390K)	T	88.4/12.0
R295	7030006610	S.RES ERJ2GEJ 394 X (390K)	T	101.0/17.3
R299	7030008300	S.RES ERJ2GEJ 184 X (180K)	B	74.6/38.5
R300	7030005720	S.RES ERJ2GEJ 563 X (56K)	B	76.8/40.6
R301	7030005100	S.RES ERJ2GEJ 154 X (150K)	B	67.5/40.5
R302	7030005720	S.RES ERJ2GEJ 563 X (56K)	B	66.9/38.3
R308	7030009140	S.RES ERJ2GEJ 272 X (2.7K)	T	56.9/54.9
R311	7030010040	S.RES ERJ2GEJ-JPW	B	94.9/32.2
R3				

[MAIN-B UNIT] (For [High band] versions)

REF NO.	PARTS NO.	DESCRIPTION	M.	H/V LOCATION
R613	7030005120	S.RES ERJ2GEJ 102 X (1K)	T	81.2/39.3
R614	7030005030	S.RES ERJ2GEJ 152 X (1.5K)	B	56.2/24.3
R615	7030005040	S.RES ERJ2GEJ 472 X (4.7K)	T	50.7/27.7
R616	7030008300	S.RES ERJ2GEJ 184 X (180K)	B	59.9/19.6
R617	7030005090	S.RES ERJ2GEJ 104 X (100K)	B	57.4/15.4
R618	7030004980	S.RES ERJ2GEJ 101 X (100)	B	62.1/16.9
R619	7030005030	S.RES ERJ2GEJ 152 X (1.5K)	B	36.0/27.5
R620	7030005240	S.RES ERJ2GEJ 473 X (47K)	B	57.4/18.4
R621	7410001130	S.ARR EXB28V102JX	B	76.6/19.6
R622	7030007570	S.RES ERJ2GEJ 122 X (1.2K)	B	83.8/21.6
R623	7030005090	S.RES ERJ2GEJ 104 X (100K)	T	50.7/26.1
R624	7030005090	S.RES ERJ2GEJ 104 X (100K)	T	83.2/11.6
R625	7030010040	S.RES ERJ2GEJ-JPW	B	96.1/20.1
R1003	7030007601	S.RES ERA3YKD 913V (91K)	B	72.6/9.4
R1004	7030006101	S.RES ERA3YED 183V (18K)	B	70.2/10.2
R1005	7030005120	S.RES ERJ2GEJ 102 X (1K)	T	112.3/16.5
R1006	7030005090	S.RES ERJ2GEJ 104 X (100K)	B	112.4/8.1
R1008	7030010040	S.RES ERJ2GEJ-JPW	T	124.9/24.8
R1009	7030005050	S.RES ERJ2GEJ 103 X (10K)	T	133.3/49.2
R1010	7030005050	S.RES ERJ2GEJ 103 X (10K)	T	128.6/23.8
R1012	7030005040	S.RES ERJ2GEJ 472 X (4.7K)	T	110.6/46.0
R1013	7030005240	S.RES ERJ2GEJ 473 X (47K)	T	114.7/49.0
R1014	7030005090	S.RES ERJ2GEJ 104 X (100K)	T	98.3/12.1
R1015	7030005120	S.RES ERJ2GEJ 102 X (1K)	B	115.3/22.8
R1016	7030005090	S.RES ERJ2GEJ 104 X (100K)	B	115.6/6.1
R1018	7030005090	S.RES ERJ2GEJ 104 X (100K)	T	111.7/7.0
R1020	7030005090	S.RES ERJ2GEJ 104 X (100K)	B	114.7/24.9
R1021	7030005120	S.RES ERJ2GEJ 102 X (1K)	B	116.5/6.1
R1022	7030005120	S.RES ERJ2GEJ 102 X (1K)	T	114.9/7.1
R1023	7030005050	S.RES ERJ2GEJ 103 X (10K)	B	125.2/15.7
R1024	7030007290	S.RES ERJ2GEJ 222 X (2.2K)	B	131.6/17.6
R1025	7030000480	S.RES MCR10EZHH 6.8K (682)	B	129.4/47.0
R1026	7030000480	S.RES MCR10EZHH 6.8K (682)	B	129.4/48.8
R1027	7030010040	S.RES ERJ2GEJ-JPW	T	113.7/16.5
R1028	7030004970	S.RES ERJ2GEJ 470 X (47)	B	114.9/13.4
R1029	7030005120	S.RES ERJ2GEJ 102 X (1K)	T	115.3/10.5
R1030	7030005050	S.RES ERJ2GEJ 103 X (10K)	T	114.4/10.5
R1031	7030005050	S.RES ERJ2GEJ 103 X (10K)	B	117.8/7.7
R1032	7030005050	S.RES ERJ2GEJ 103 X (10K)	B	127.1/19.9
R1033	7030000480	S.RES MCR10EZHH 6.8K (682)	B	129.4/45.2
R1034	7030005040	S.RES ERJ2GEJ 472 X (4.7K)	B	123.6/17.5
R1035	7030005050	S.RES ERJ2GEJ 103 X (10K)	T	107.8/42.5
R1036	7030005040	S.RES ERJ2GEJ 472 X (4.7K)	T	107.8/41.2
R1037	7030005090	S.RES ERJ2GEJ 104 X (100K)	T	95.9/13.5
R1038	7030005120	S.RES ERJ2GEJ 102 X (1K)	B	125.6/36.3
R1039	7030005090	S.RES ERJ2GEJ 104 X (100K)	B	113.7/12.9
R1040	7030005160	S.RES ERJ2GEJ 105 X (1M)	T	111.2/12.9
R1043	7030005160	S.RES ERJ2GEJ 105 X (1M)	B	112.0/11.0
R1044	7030005090	S.RES ERJ2GEJ 104 X (100K)	B	117.9/9.9
R1045	7030005050	S.RES ERJ2GEJ 103 X (10K)	B	120.4/17.1
R1046	7030005800	S.RES RR0510P-102-D (1K)	B	119.7/9.0
R1047	7030005050	S.RES ERJ2GEJ 103 X (10K)	B	119.4/18.6
R1048	7030009710	S.RES ERJ2GEJ 203 X (20K)	B	119.0/22.4
R1049	7030005040	S.RES ERJ2GEJ 472 X (4.7K)	B	116.7/19.7
R1050	7030007290	S.RES ERJ2GEJ 222 X (2.2K)	B	123.0/38.1
R1054	7030008270	S.RES RR0510P-104-D (100K)	B	119.7/9.9
R1055	7030005090	S.RES ERJ2GEJ 104 X (100K)	B	120.4/15.2
R1056	7030008270	S.RES RR0510P-104-D (100K)	B	118.8/10.8
R1057	7030005100	S.RES ERJ2GEJ 154 X (150K)	B	118.8/15.2
R1059	7410001130	S.ARR EXB28V102JX	T	69.7/14.8
R1060	7410001130	S.ARR EXB28V102JX	T	63.4/14.8
R1062	7030008270	S.RES RR0510P-104-D (100K)	B	116.0/14.8
R1063	7030007340	S.RES ERJ2GEJ 153 X (15K)	B	42.8/22.4
R1064	7030005090	S.RES ERJ2GEJ 104 X (100K)	T	40.5/23.1
R1068	7030005120	S.RES ERJ2GEJ 102 X (1K)	T	74.3/14.1
R1069	7030005120	S.RES ERJ2GEJ 102 X (1K)	T	72.6/14.1
R1070	7030005120	S.RES ERJ2GEJ 102 X (1K)	T	57.3/15.1
R1071	7030005090	S.RES ERJ2GEJ 104 X (100K)	T	51.7/16.7
R1072	7030005040	S.RES ERJ2GEJ 472 X (4.7K)	T	52.9/16.3
R1073	7030005700	S.RES ERJ2GEJ 274 X (270K)	B	50.8/18.7
R1074	7030005100	S.RES ERJ2GEJ 154 X (150K)	T	37.2/20.6
R1075	7030008010	S.RES ERJ2GEJ 123 X (12K)	B	36.3/21.5
R1076	7030005090	S.RES ERJ2GEJ 104 X (100K)	B	35.0/20.5
R1077	7030005170	S.RES ERJ2GEJ 474 X (470K)	B	36.6/20.2
R1078	7030005090	S.RES ERJ2GEJ 104 X (100K)	B	32.2/15.2
R1080	7030005310	S.RES ERJ2GEJ 124 X (120K)	B	40.1/13.5
R1081	7030008290	S.RES ERJ2GEJ 183 X (18K)	T	42.5/19.3
R1082	7410001130	S.ARR EXB28V102JX	T	56.9/6.7
R1083	7030005120	S.RES ERJ2GEJ 102 X (1K)	B	69.1/8.8
R1084	7410001130	S.ARR EXB28V102JX	T	61.7/6.1
R1085	7030005120	S.RES ERJ2GEJ 102 X (1K)	B	49.5/9.9
R1086	7030005100	S.RES ERJ2GEJ 154 X (150K)	B	32.2/18.5
R1087	7030007340	S.RES ERJ2GEJ 153 X (15K)	B	31.3/15.2
R1088	7030005160	S.RES ERJ2GEJ 105 X (1M)	B	30.3/15.6
R1089	7030005050	S.RES ERJ2GEJ 103 X (10K)	B	44.2/16.9
R1090	7030008300	S.RES ERJ2GEJ 184 X (180K)	B	36.5/13.4
R1092	7030008400	S.RES ERJ2GEJ 182 X (1.8K)	B	38.3/13.5
R1093	7030005090	S.RES ERJ2GEJ 104 X (100K)	B	42.9/15.5
R1094	7030005090	S.RES ERJ2GEJ 104 X (100K)	T	55.7/12.8
R1095	7030009290	S.RES ERJ2GEJ 562 X (5.6K)	T	55.7/13.7
R1096	7030005100	S.RES ERJ2GEJ 154 X (150K)	B	35.6/13.4
R1097	7030007290	S.RES ERJ2GEJ 222 X (2.2K)	T	55.2/11.6
R1098	7510001730	S.THE ERTJJOEP 473J	T	74.9/15.5
R1099	7030008270	S.RES RR0510P-104-D (100K)	T	72.5/15.5
R1100	7410001130	S.ARR EXB28V102JX	T	75.3/6.0
R1101	7030005290	S.RES ERJ2GEJ 682 X (6.8K)	B	44.0/20.4
R1102	7030005040	S.RES ERJ2GEJ 472 X (4.7K)	B	42.4/16.4
R1103	7030005290	S.RES ERJ2GEJ 682 X (6.8K)	B	50.9/18.3
R1105	7030003860	S.RES ERJ3GE JPW V	T	127.8/48.9
R1106	7030009290	S.RES ERJ2GEJ 562 X (5.6K)	B	41.0/20.8
R1107	7030008410	S.RES ERJ2GEJ 392 X (3.9K)	B	39.2/20.8
R1108	7030005240	S.RES ERJ2GEJ 473 X (47K)	B	124.9/41.7
R1111	7030005060	S.RES ERJ2GEJ 333 X (33K)	T	36.3/19.7
R1112	7030005230	S.RES ERJ2GEJ 334 X (330K)	B	41.5/19.6
R1113	7030005720	S.RES ERJ2GEJ 563 X (56K)	B	44.0/21.3

[MAIN-B UNIT] (For [High band] versions)

REF NO.	PARTS NO.	DESCRIPTION	M.	H/V LOCATION
R1114	7030005120	S.RES ERJ2GEJ 102 X (1K)	T	65.8/6.4
R1115	7030005120	S.RES ERJ2GEJ 102 X (1K)	T	65.8/5.4
R1116	7030007300	S.RES ERJ2GEJ 332 X (3.3K)	T	73.7/15.0
R1117	7030005090	S.RES ERJ2GEJ 104 X (100K)	T	42.4/18.2
R1119	7030003860	S.RES ERJ3GE JPW V	T	99.5/68.6
		[USA-02] [EXP-04]		
R2003	7030003860	S.RES ERJ3GE JPW V	B	16.7/6.8
R2004	7030005210	S.RES ERJ2GEJ 822 X (8.2K)	B	12.6/8.8
R2005	7030005210	S.RES ERJ2GEJ 822 X (8.2K)	B	15.8/6.8
R2009	7030007290	S.RES ERJ2GEJ 222 X (2.2K)	B	10.5/11.7
R2010	7030004980	S.RES ERJ2GEJ 101 X (100)	T	11.5/11.7
R2011	7030004980	S.RES ERJ2GEJ 101 X (100)	T	23.0/10.4
R2012	7030004980	S.RES ERJ2GEJ 101 X (100)	T	22.5/11.3
R2013	7030005240	S.RES ERJ2GEJ 473 X (47K)	B	19.8/12.0
R2015	7030005240	S.RES ERJ2GEJ 473 X (47K)	T	18.4/11.6
R2016	7030010040	S.RES ERJ2GEJ-JPW	B	24.0/5.8
R2019	7030010040	S.RES ERJ2GEJ-JPW	B	9.9/17.9
R2020	7030010040	S.RES ERJ2GEJ-JPW	B	14.4/11.1
R2021	7030004980	S.RES ERJ2GEJ 101 X (100)	B	23.6/12.1
R2022	7030004980	S.RES ERJ2GEJ 101 X (100)	B	27.9/24.7
R2024	7030005240	S.RES ERJ2GEJ 473 X (47K)	B	26.6/21.6
R2026	7030004970	S.RES ERJ2GEJ 470 X (47)	B	27.9/22.9
R2028	7030005240	S.RES ERJ2GEJ 473 X (47K)	B	12.1/19.3
R2030	7030005240	S.RES ERJ2GEJ 473 X (47K)	B	11.0/21.2
R2031	7030005240	S.RES ERJ2GEJ 473 X (47K)	B	10.7/29.4
R2032	7030005240	S.RES ERJ2GEJ 473 X (47K)	B	24.9/17.4
R2034	7030005240	S.RES ERJ2GEJ 473 X (47K)	B	28.8/10.5
R2035	7030005240	S.RES ERJ2GEJ 473 X (47K)	B	26.7/14.9
R2036	7030004980	S.RES ERJ2GEJ 101 X (100)	T	26.8/11.9
R2037	7030007290	S.RES ERJ2GEJ 222 X (2.2K)	T	28.1/10.7
R2038	7030004970	S.RES ERJ2GEJ 470 X (47)	B	28.8/12.1
R2039	7030005240	S.RES ERJ2GEJ 473 X (47K)	B	24.1/9.5
R2040	7030005240	S.RES ERJ2GEJ 473 X (47K)	B	24.5/12.1
R2043	7410001140	S.ARR EXB28V104JX	T	15.6/26.7
R2044	7410001140	S.ARR EXB28V104JX	B	20.8/26.3
R2045	7410001140	S.ARR EXB28V104JX	T	27.0/22.6
R2046	7410001140	S.ARR EXB28V104JX	T	19.3/26.7
R2047	7410001140	S.ARR EXB28V104JX	B	10.9/14.5
R2048	7030005090	S.RES ERJ2GEJ 104 X (100K)	T	25.7/14.6
R2049	7030005090	S.RES ERJ2GEJ 104 X (100K)	B	21.8/15.6
R2050	7410001140	S.ARR EXB28V104JX	B	22.6/18.2
R2051	7410001140	S.ARR EXB28V104JX	T	9.9/17.6
R2052	7030005090	S.RES ERJ2GEJ 104 X (100K)	T	16.8/11.6
R2053	7030005090	S.RES ERJ2GEJ 104 X (100K)	B	16.0/14.5
R2056	7030010040	S.RES ERJ2GEJ-JPW	T	10.6/20.0
R2057	7030005090	S.RES ERJ2GEJ 104 X (100K)	T	10.4/22.9
R2058	7410001140	S.ARR EXB28V104JX	B	17.0/18.6
R2059	7030005090	S.RES ERJ2GEJ 104 X (100K)	T	10.4/23.8
R2060	7030005090	S.RES ERJ2GEJ 104 X (100K)	T	25.7/15.6
R2061	7030005090	S.RES ERJ2GEJ 104 X (100K)	B	14.7/12.6
R2062	7030005090	S.RES ERJ2GEJ 104 X (100K)	B	17.7/14.4
R2063	7030005090	S.RES ERJ2GEJ 104 X (100K)	B	22.1/23.4
R2064	7030005090	S.RES ERJ2GEJ 104 X (100K)	B	19.7/17.7
R2065	7030005030	S.RES ERJ2GEJ 152 X (1.5K)	B	13.8/8.8
R2066	7410001170	S.ARR EXB28V470JX	T	21.3/6.7
R2067	7030010040	S.RES ERJ2GEJ-JPW	T	11.4/5.3
R2068	7030010040	S.RES ERJ2GEJ-JPW	T	20.9/10.4
R2071	7030010040	S.RES ERJ2GEJ-JPW	T	24.9/5.7
R2072	7030005050	S.RES ERJ2GEJ 103 X (10K)	B	12.2/10.1
R2074	7030010040	S.RES ERJ2GEJ-JPW	T	8.7/10.0
R2084	7030010040	S.RES ERJ2GEJ-JPW	T	30.7/10.5
R2085	7030010040	S.RES ERJ2GEJ-JPW	B	19.5/9.6
C1	4030011050	S.CER GRM31M3C2H3R0CY21L (GRM42-6 CJ)	B	8.4/66.6
C2	4030011070	S.CER GRM31M2C2H5R0CY21L (GRM42-6 CH)	B	7.4/58.6
C3	4030009500	S.CER C1608 CH 1H 0R5B-T	B	25.6/51.9
C4	4030009500	S.CER C1608 CH 1H 0R5B-T	B	16.4/51.9
C5	4030009500	S.CER C1608 CH 1H 0R5B-T	B	8.2/54.5
C6	4030011060	S.CER GRM31M2C2H4R0CY21L (GRM42-6 CH)	B	7.4/56.3
C7	4030011070	S.CER GRM31M2C2H5R0CY21L (GRM42-6 CH)	B	13.1/60.7
C8	4030011050	S.CER GRM31M3C2H3R0CY21L (GRM42-6 CJ)	B	19.5/60.7
C9	4030011050	S.CER GRM31M3C2H3R0CY21L (GRM42-6 CJ)	T	30.6/53.1
C10	4030017730	S.CER C1005 JB 1H 471K-T	B	18.1/48.1
C11	4030017730	S.CER C1005 JB 1H 471K-T	B	10.0/49.2
C12	4030017730	S.CER C1005 JB 1H 471K-T	T	39.4/54.

[MAIN-B UNIT] (For [High band] versions)

REF NO.	PARTS NO.	DESCRIPTION	M.	H/V LOCATION
C43	4030016930	S.CER C1005 JB 1A 104K-T	B	54.1/38.3
C44	4030017560	S.CER C1005 CH 1H 2R5B-T	B	59.9/40.5
C45	4030017620	S.CER C1005 CH 1H 100C-T	B	55.5/42.0
C48	4030017420	S.CER C1005 CH 1H 470J-T	B	72.2/40.6
C49	4030017380	S.CER C1005 CH 1H 050B-T	B	75.9/39.2
C50	4030017460	S.CER C1005 JB 1H 102K-T	B	73.1/40.6
C51	4030017460	S.CER C1005 JB 1H 102K-T	T	72.4/41.1
C52	4030017620	S.CER C1005 CH 1H 100C-T	B	70.4/41.2
C53	4030016790	S.CER C1005 JB 1E 103K-T	B	71.3/42.8
C54	4030017730	S.CER C1005 JB 1H 471K-T	B	70.4/42.8
C57	4030017460	S.CER C1005 JB 1H 102K-T	B	74.6/36.7
C58	4030017460	S.CER C1005 JB 1H 102K-T	T	67.2/26.1
C59	4030017460	S.CER C1005 JB 1H 102K-T	T	66.9/22.7
C60	4030016790	S.CER C1005 JB 1E 103K-T	T	65.3/26.6
C61	4030017430	S.CER C1005 CH 1H 101J-T	T	61.6/23.1
C62	4030017420	S.CER C1005 CH 1H 470J-T	B	57.1/24.3
C63	4030017420	S.CER C1005 CH 1H 470J-T	T	60.3/14.3
C64	4030016790	S.CER C1005 JB 1E 103K-T	B	56.2/26.8
C65	4030018860	S.CER C1005 JB 0J 105K-T	T	58.2/19.6
C66	4030017460	S.CER C1005 JB 1H 102K-T	T	54.7/19.9
C67	4030017460	S.CER C1005 JB 1H 102K-T	B	58.4/21.3
C68	4030017680	S.CER C1005 CH 1H 082J-T	T	52.2/23.8
C69	4030017710	S.CER C1005 CH 1H 181J-T	T	54.0/23.8
C70	4030017710	S.CER C1005 CH 1H 181J-T	T	54.0/25.6
C71	4030016930	S.CER C1005 JB 1A 104K-T	T	57.4/29.0
C72	4030017730	S.CER C1005 JB 1H 471K-T	[USA-02] [EXP-04]	T 59.8/48.0
C74	4030017730	S.CER C1005 JB 1H 471K-T	B	11.2/50.5
C75	4030019560	S.CER GRM21BB31C106KE15L	T	61.6/25.3
C76	4030016790	S.CER C1005 JB 1E 103K-T	T	57.8/54.9
C77	4030017460	S.CER C1005 JB 1H 102K-T	T	56.8/50.7
C78	4030017730	S.CER C1005 JB 1H 471K-T	B	58.8/56.6
C79	4030016960	S.CER C1005 JB 1E 183K-T	T	62.4/55.0
C81	4030017460	S.CER C1005 JB 1H 102K-T	T	65.1/55.0
C82	4030011050	S.CER GRM31M3C2H3R0CY21L (GRM42-6 CJ)	T	34.9/65.2
C84	4030017420	S.CER C1005 CH 1H 470J-T	T	55.0/61.6
C85	4030017460	S.CER C1005 JB 1H 102K-T	T	56.0/61.6
C86	4030017710	S.CER C1005 CH 1H 181J-T	T	81.3/63.8
C87	4030017460	S.CER C1005 JB 1H 102K-T	T	79.8/68.8
C88	4030017730	S.CER C1005 JB 1H 471K-T	T	64.6/52.1
C89	4030017590	S.CER C1005 CH 1H 070C-T	B	87.3/57.5
C90	4030017590	S.CER C1005 CH 1H 070C-T	B	88.2/57.5
C92	4030017570	S.CER C1005 CH 1H 040B-T	B	89.9/58.0
C93	4030017590	S.CER C1005 CH 1H 070C-T	B	86.9/51.5
C96	4030017460	S.CER C1005 JB 1H 102K-T	B	87.8/56.3
C97	4030017730	S.CER C1005 JB 1H 471K-T	B	87.8/55.4
C98	4030017390	S.CER C1005 CH 1H 180J-T	B	83.5/48.7
C99	4030017730	S.CER C1005 JB 1H 471K-T	B	81.4/48.3
C100	4030017590	S.CER C1005 CH 1H 070C-T	B	91.2/34.9
C102	4030017590	S.CER C1005 CH 1H 070C-T	B	97.1/33.8
C103	4030017360	S.CER C1005 CH 1H 030B-T	B	98.5/32.2
C104	4030017460	S.CER C1005 JB 1H 102K-T	B	100.8/29.9
C105	4030017730	S.CER C1005 JB 1H 471K-T	B	97.6/28.9
C106	4030017420	S.CER C1005 CH 1H 470J-T	B	91.7/48.9
C107	4030017460	S.CER C1005 JB 1H 102K-T	T	80.2/51.7
C108	4030016790	S.CER C1005 JB 1E 103K-T	B	81.3/49.2
C109	4030017460	S.CER C1005 JB 1H 102K-T	B	95.8/35.3
C110	4030017730	S.CER C1005 JB 1H 471K-T	B	98.6/35.3
C111	4030017730	S.CER C1005 JB 1H 471K-T	T	101.7/37.1
C112	4030016930	S.CER C1005 JB 1A 104K-T	T	100.8/37.1
	4030017520	S.CER C1005 CH 1H 0R3B-T	[USA-02] [EXP-04]	B 102.0/29.6
	4030017520	S.CER C1005 CH 1H 0R3B-T		
C114	4030017600	S.CER C1005 CH 1H 080C-T	B	98.3/26.1
C115	4030017620	S.CER C1005 CH 1H 100C-T	B	98.8/21.9
C116	4030017460	S.CER C1005 JB 1H 102K-T	B	107.5/30.0
C117	4030017730	S.CER C1005 JB 1H 471K-T	B	107.5/30.9
C118	4030017520	S.CER C1005 CH 1H 0R3B-T	B	102.8/32.0
C119	4030016790	S.CER C1005 JB 1E 103K-T	B	97.0/21.9
C120	4030017730	S.CER C1005 JB 1H 471K-T	B	97.9/21.9
C121	4030017590	S.CER C1005 CH 1H 070C-T	B	103.3/30.8
C122	4030017620	S.CER C1005 CH 1H 100C-T	B	107.5/31.8
C123	4030017600	S.CER C1005 CH 1H 080C-T	B	104.8/28.2
C124	4030017640	S.CER C1005 CH 1H 150J-T	B	105.0/20.8
C125	4030017420	S.CER C1005 CH 1H 470J-T	B	101.7/27.5
C126	4030017380	S.CER C1005 CH 1H 050B-T	B	95.6/23.7
C127	4030017640	S.CER C1005 CH 1H 150J-T	B	96.1/21.9
C128	4030017360	S.CER C1005 CH 1H 030B-T	B	99.2/27.3
C129	4030017520	S.CER C1005 CH 1H 0R3B-T	B	103.5/27.5
C131	4030017540	S.CER C1005 CH 1H R75B-T	B	106.4/27.2
C132	4030017460	S.CER C1005 JB 1H 102K-T	T	94.3/12.6
C133	4030017610	S.CER C1005 CH 1H 090C-T	B	105.4/22.7
C134	4030017600	S.CER C1005 CH 1H 080C-T	B	93.7/22.8
C135	4030016790	S.CER C1005 JB 1E 103K-T	B	78.3/21.0
C139	4030016930	S.CER C1005 JB 1A 104K-T	B	107.5/33.6
C140	4030017430	S.CER C1005 CH 1H 101J-T	B	81.2/18.9
C141	4030017460	S.CER C1005 JB 1H 102K-T	T	75.7/21.5
C143	4030017460	S.CER C1005 JB 1H 102K-T	T	78.9/22.2
C144	4030017420	S.CER C1005 CH 1H 470J-T	T	92.5/16.1
C146	4550000520	S.TAN TEESVA 1V 683M8R	T	84.7/22.9
C147	4550003250	S.TAN TEESVA 1V 474M8R	T	80.5/22.9
C148	4030019560	S.CER GRM21BB31C106KE15L	T	109.7/30.5
C151	4030016930	S.CER C1005 JB 1A 104K-T	B	75.3/18.1
C152	4030017420	S.CER C1005 CH 1H 470J-T	B	77.8/18.1
C153	4030017420	S.CER C1005 CH 1H 470J-T	B	78.1/16.2
C154	4030017420	S.CER C1005 CH 1H 470J-T	B	76.4/16.2
C155	4030017460	S.CER C1005 JB 1H 102K-T	B	81.7/16.7
C156	4030016790	S.CER C1005 JB 1E 103K-T	B	81.2/17.9
C157	4030017620	S.CER C1005 CH 1H 100C-T	B	72.4/24.4
C160	4030016930	S.CER C1005 JB 1A 104K-T	B	74.2/21.3
C162	4030016790	S.CER C1005 JB 1E 103K-T	B	72.4/17.7
C165	4030017460	S.CER C1005 JB 1H 102K-T	B	74.1/23.5
C192	4030017350	S.CER C1005 CH 1H 020B-T	B	34.3/40.5
C193	4030017530	S.CER C1005 CH 1H 0R5B-T	B	51.5/38.3
C277	4030016930	S.CER C1005 JB 1A 104K-T	B	36.0/28.4

[MAIN-B UNIT] (For [High band] versions)

REF NO.	PARTS NO.	DESCRIPTION	M.	H/V LOCATION
C281	4030017770	S.CER C1005 JB 1H 332K-T	T	92.0/13.5
C282	4030016930	S.CER C1005 JB 1A 104K-T	T	44.2/28.0
C283	4030016930	S.CER C1005 JB 1A 104K-T	T	42.5/25.2
C284	4030016930	S.CER C1005 JB 1A 104K-T	T	44.2/28.9
C285	4030017570	S.CER C1005 CH 1H 040B-T	T	94.0/29.9
C286	4030017600	S.CER C1005 CH 1H 080C-T	B	36.4/26.3
C287	4030017460	S.CER C1005 JB 1H 102K-T	T	95.9/11.7
C298	4030017370	S.CER C1005 CH 1H 3R5B-T	T	86.3/29.4
C299	4030017370	S.CER C1005 CH 1H 3R5B-T	T	83.9/29.4
C300	4030017350	S.CER C1005 CH 1H 020B-T	T	85.1/30.8
C301	4030017730	S.CER C1005 JB 1H 471K-T	B	92.8/31.3
C302	4030017420	S.CER C1005 CH 1H 470J-T	B	80.1/39.2
C303	4030017730	S.CER C1005 JB 1H 471K-T	B	80.1/36.3
C305	4030017500	S.CER C1005 CH 1H 560J-T	B	64.8/24.2
C306	4030017580	S.CER C1005 CH 1H 060C-T	B	64.3/25.4
C307	4030017500	S.CER C1005 CH 1H 560J-T	B	61.3/22.7
C308	4030017360	S.CER C1005 CH 1H 030B-T	B	60.1/23.2
C309	4030016790	S.CER C1005 JB 1E 103K-T	B	67.4/21.8
C312	4030016930	S.CER C1005 JB 1A 104K-T	B	67.4/20.9
C314	4030016790	S.CER C1005 JB 1E 103K-T	T	110.5/33.8
C323	4030017620	S.CER C1005 CH 1H 100C-T	B	72.3/26.0
C332	4030017530	S.CER C1005 CH 1H 0R5B-T	B	84.9/50.2
C333	4030017420	S.CER C1005 CH 1H 470J-T	B	40.4/40.7
C334	4030017590	S.CER C1005 CH 1H 070C-T	B	94.9/68.3
C335	4030017630	S.CER C1005 CH 1H 120J-T	B	93.8/68.3
C336	4030017710	S.CER C1005 CH 1H 181J-T	B	62.0/68.7
C337	4030017460	S.CER C1005 JB 1H 102K-T	T	82.7/29.2
C340	4030017710	S.CER C1005 CH 1H 181J-T	T	107.7/28.7
C342	4550002980	S.TAN TEESVA 1C 225M8R	B	78.4/66.1
C343	4030017460	S.CER C1005 JB 1H 102K-T	B	51.5/39.2
C344	4030017460	S.CER C1005 JB 1H 102K-T	B	54.2/68.0
C345	4030017730	S.CER C1005 JB 1H 471K-T	B	54.2/67.1
C346	4030017420	S.CER C1005 CH 1H 470J-T	B	66.0/68.7
C347	4030017460	S.CER C1005 JB 1H 102K-T	T	52.2/22.9
C348	4030017460	S.CER C1005 JB 1H 102K-T	T	59.3/20.5
C350	4030017920	S.CER C1005 JB 1A 683K-T	T	95.9/14.4
C357	4030016930	S.CER C1005 JB 1A 104K-T	T	103.5/34.7
C358	4030017340	S.CER C1005 CH 1H 010B-T	B	91.2/35.8
C366	4030017460	S.CER C1005 JB 1H 102K-T	B	97.0/64.4
C367	4030017730	S.CER C1005 JB 1H 471K-T	B	97.0/65.8
C368	4030017420	S.CER C1005 CH 1H 470J-T	B	97.0/67.3
C372	4030017730	S.CER C1005 JB 1H 471K-T	T	60.3/67.7
C376	4030017390	S.CER C1005 JB 1H 471K-T	B	88.7/49.5
C377	4030017460	S.CER C1005 JB 1H 102K-T	T	57.8/61.6
C383	4030018860	S.CER C1005 JB 0J 105K-T	T	36.4/36.2
C384	4030016930	S.CER C1005 JB 1A 104K-T	T	59.3/29.0
C385	4030016930	S.CER C1005 JB 1A 104K-T	B	54.9/28.9
C388	4030017730	S.CER C1005 JB 1H 471K-T	B	68.2/36.7
C390	4030017460	S.CER C1005 JB 1H 102K-T	B	75.0/40.6
C391	4030017420	S.CER C1005 CH 1H 470J-T	B	75.9/40.6
C392	4030017520	S.CER C1005 CH 1H 0R3B-T	B	60.3/39.2
C393	4030017550	S.CER C1005 CH 1H 1R5B-T	B	66.3/40.5
C394	4030016930	S.CER C1005 JB 1A 104K-T	B	50.9/28.8
C395	4030016930	S.CER C1005 JB 1A 104K-T	B	45.1/29.0
C396	4030016930	S.CER C1005 JB 1A 104K-T	T	55.8/29.0
C397	4030016790	S.CER C1005 JB 1E 103K-T	B	50.4/12.7
C398	4030016790	S.CER C1005 JB 1E 103K-T	B	48.6/27.3
C399	4030016790	S.CER C1005 JB 1E 103K-T	B	48.3/28.5
C400	4030017710	S.CER C1005 CH 1H 181J-T	T	81.2/37.6
C401	4030017580	S.CER C1005 CH 1H 060C-T	B	78.6/40.6
C402	4030011040	S.CER GRM31M4C2H2R0CY21L (GRM42-6 CK)	B	38.0/68.7
C404	4030011060	S.CER GRM31M2C2H4R0CY21L (GRM42-6 CH)	B	15.5/60.7
C408	4030017730	S.CER C1005 JB 1H 471K-T	B	23.9/48.1
C409	4030017460	S.CER C1005 JB 1H 102K-T	B	39.3/51.4
C411	4030017460	S.CER C1005 JB 1H 102K-T	[USA-02] [EXP-04]	T 42.2/55.4
	4030017460	S.CER C1005 JB 1H 102K-T		
C413	4030018860	S.CER C1005 JB 0J 105K-T	B	91.5/25.3
C416	4030017420	S.CER C1005 CH 1H 470J-T	B	93.4/25.3
C418	4030018050	S.CER C1005 JB 0J 224K-T	T	102.8/17.3
C420	4030011050	S.CER GRM31M3C2H3R0CY21L (GRM42-6 CJ)	B	21.7/60.7
C423	4030017570	S.CER C1005 CH 1H 040B-T	B	77.7/40.6
C429	4030017620	S.CER C1005 CH		

[MAIN-B UNIT] (For [High band] versions)

REF NO.	PARTS NO.	DESCRIPTION	M.	H/V LOCATION
C642	4030018890	S.CER C1005 JB 0J 224K-T	B	77.5/27.0
C643	4030017430	S.CER C1005 CH 1H 101J-T	B	77.5/27.9
C644	4030019560	S.CER GRM21BB31C106KE15L	B	81.7/20.4
C645	4030016930	S.CER C1005 JB 1A 104K-T	B	30.0/15.7
C646	4030017460	S.CER C1005 JB 1H 102K-T	T	84.7/10.0
C647	4030016790	S.CER C1005 JB 1E 103K-T	B	59.1/27.7
C1003	4030017460	S.CER C1005 JB 1H 102K-T	T	133.3/63.5
C1005	4030018980	S.CER C1608 JB 1H 104K-T	B	100.1/11.8
C1007	4030017460	S.CER C1005 JB 1H 102K-T	T	100.1/12.1
C1008	4510009680	S.ELE EEEFK1E471P	B	110.2/52.6
C1010	4030017460	S.CER C1005 JB 1H 102K-T	B	106.5/59.0
C1011	4030016930	S.CER C1005 JB 1A 104K-T	B	93.9/12.1
C1012	4030017420	S.CER C1005 CH 1H 470J-T	B	117.5/16.6
C1014	4030017460	S.CER C1005 JB 1H 102K-T	T	116.6/27.5
C1015	4030017460	S.CER C1005 JB 1H 102K-T	T	114.9/8.0
C1017	4030017460	S.CER C1005 JB 1H 102K-T	B	122.5/64.9
C1018	4030017460	S.CER C1005 JB 1H 102K-T	T	133.3/45.0
C1019	4510009250	S.ELE EEEFK1C471P	B	130.5/34.8
C1022	4030017420	S.CER C1005 CH 1H 470J-T	B	105.5/59.0
C1023	4030017460	S.CER C1005 JB 1H 102K-T	B	113.4/58.8
C1024	4030017440	S.CER C1005 CH 1H 221J-T	B	113.4/59.7
C1025	4030017510	S.CER C1005 CH 1H 680J-T	B	113.4/60.6
C1026	4030019120	S.CER GRM188B31E105KA75D	T	115.8/49.5
C1028	4030017460	S.CER C1005 JB 1H 102K-T	B	117.4/6.1
C1029	4030017460	S.CER C1005 JB 1H 102K-T	T	114.9/12.6
C1031	4030017460	S.CER C1005 JB 1H 102K-T	T	115.0/16.9
C1032	4030016930	S.CER C1005 JB 1A 104K-T	B	123.6/16.6
C1033	4510009680	S.ELE EEEFK1E471P	B	120.0/29.1
C1034	4030018860	S.CER C1005 JB 0J 105K-T	B	131.6/16.6
C1035	4030016790	S.CER C1005 JB 1E 103K-T	B	131.6/18.7
C1036	4030018980	S.CER C1608 JB 1H 104K-T	T	128.4/46.9
C1037	4030019560	S.CER GRM21BB31C106KE15L	B	129.4/43.4
C1038	4030011600	S.CER C1608 JB 1E 104K-T	T	110.5/48.7
C1039	4510009680	S.ELE EEEFK1E471P	B	117.0/41.7
C1040	4030019560	S.CER GRM21BB31C106KE15L	B	116.7/22.2
C1042	4030016930	S.CER C1005 JB 1A 104K-T	B	118.1/22.4
C1043	4030016930	S.CER C1005 JB 1A 104K-T	T	114.9/16.0
C1045	4030017460	S.CER C1005 JB 1H 102K-T	T	114.9/14.2
C1046	4030018860	S.CER C1005 JB 0J 105K-T	T	114.9/15.1
C1048	4030018900	S.CER C1005 JB 0J 474K-T	B	126.7/18.6
C1050	4030018860	S.CER C1005 JB 0J 105K-T	B	125.2/16.6
C1051	4030017460	S.CER C1005 JB 1H 102K-T	B	122.1/48.2
C1052	4030016930	S.CER C1005 JB 1A 104K-T	T	127.8/40.1
C1053	4030019560	S.CER GRM21BB31C106KE15L	T	127.8/44.5
C1056	4030018860	S.CER C1005 JB 0J 105K-T	T	111.2/11.7
C1057	4030016930	S.CER C1005 JB 1A 104K-T	B	118.7/17.1
C1058	4030019560	S.CER GRM21BB31C106KE15L	T	105.5/44.4
C1059	4030017460	S.CER C1005 JB 1H 102K-T	T	107.7/46.3
C1060	4030017460	S.CER C1005 JB 1H 102K-T	B	126.2/39.8
C1061	4030017460	S.CER C1005 JB 1H 102K-T	T	107.7/37.4
C1062	4030017460	S.CER C1005 JB 1H 102K-T	B	120.7/22.9
C1063	4030019560	S.CER GRM21BB31C106KE15L	B	126.9/22.2
C1064	4030019560	S.CER GRM21BB31C106KE15L	B	121.6/36.0
C1065	4030017460	S.CER C1005 JB 1H 102K-T	B	120.2/35.6
C1066	4030018860	S.CER C1005 JB 0J 105K-T	B	125.6/38.1
C1070	4030017440	S.CER C1005 CH 1H 221J-T	B	120.4/16.2
C1071	4030016930	S.CER C1005 JB 1A 104K-T	B	120.4/10.8
C1074	4030017460	S.CER C1005 JB 1H 102K-T	B	73.9/10.4
C1075	4030017460	S.CER C1005 JB 1H 102K-T	B	70.7/14.4
C1076	4030017460	S.CER C1005 JB 1H 102K-T	B	69.7/14.4
C1077	4030017460	S.CER C1005 JB 1H 102K-T	B	68.8/14.4
C1080	4030016790	S.CER C1005 JB 1E 103K-T	B	51.1/15.3
C1081	4030016930	S.CER C1005 JB 1A 104K-T	B	117.2/15.2
C1082	4030016930	S.CER C1005 JB 1A 104K-T	B	114.8/14.6
C1083	4030017460	S.CER C1005 JB 1H 102K-T	B	37.6/19.3
C1084	4030017710	S.CER C1005 CH 1H 181J-T	B	41.9/20.8
C1092	4030016930	S.CER C1005 JB 1A 104K-T	B	75.8/14.4
C1095	4030016930	S.CER C1005 JB 1A 104K-T	T	38.5/19.3
C1096	4030018860	S.CER C1005 JB 0J 105K-T	T	51.7/18.5
C1097	4030018240	S.CER C1005 JB 1H 562K-T	B	50.8/17.8
C1098	4030018860	S.CER C1005 JB 0J 105K-T	T	54.5/16.3
C1099	4030018860	S.CER C1005 JB 0J 105K-T	B	45.2/20.8
C1100	4030017460	S.CER C1005 JB 1H 102K-T	B	75.8/9.1
C1101	4030016930	S.CER C1005 JB 1A 104K-T	T	78.2/8.0
C1102	4030017420	S.CER C1005 CH 1H 470J-T	B	71.6/6.6
C1106	4030016930	S.CER C1005 JB 1A 104K-T	T	36.3/20.6
C1107	4030017440	S.CER C1005 CH 1H 221J-T	B	33.1/15.2
C1108	4030017450	S.CER C1005 JB 1H 271K-T	B	39.2/13.5
C1109	4030018860	S.CER C1005 JB 0J 105K-T	T	42.5/18.0
C1110	4030018860	S.CER C1005 JB 0J 105K-T	T	42.5/20.4
C1111	4030018860	S.CER C1005 JB 0J 105K-T	B	46.6/19.1
C1112	4030016930	S.CER C1005 JB 1A 104K-T	B	45.7/19.1
C1119	4030017420	S.CER C1005 CH 1H 470J-T	B	65.2/6.9
C1127	4030017660	S.CER C1005 CH 1H 330J-T	B	36.6/21.2
C1128	4030016930	S.CER C1005 JB 1A 104K-T	B	31.3/13.6
C1129	4030016930	S.CER C1005 JB 1A 104K-T	B	32.2/16.9
C1130	4030017900	S.CER C1005 JB 1E 123K-T	B	37.4/13.5
C1131	4550006970	S.TAN TEESVJ 0G 476M8R	T	53.5/12.1
C1132	4030017460	S.CER C1005 JB 1H 102K-T	T	51.8/13.0
C1133	4030016790	S.CER C1005 JB 1E 103K-T	T	78.2/5.7
C1135	4030017460	S.CER C1005 JB 1H 102K-T	T	73.9/16.8
C1136	4030016930	S.CER C1005 JB 1A 104K-T	T	71.6/15.5
C1137	4030016970	S.CER C1005 JB 1E 223K-T	B	40.1/20.8
C1138	4030017460	S.CER C1005 JB 1H 102K-T	T	37.7/15.7
C1139	4030017920	S.CER C1005 JB 1A 683K-T	T	54.5/17.2
C1140	4030017040	S.CER C1005 JB 1A 333K-T	B	52.0/18.3
C1141	4030016790	S.CER C1005 JB 1E 103K-T	B	42.4/17.3
C1142	4030016930	S.CER C1005 JB 1A 104K-T	B	117.6/11.8
C1143	4030018980	S.CER C1608 JB 1H 104K-T	B	93.8/9.4
C1144	4030016930	S.CER C1005 JB 1A 104K-T	B	41.7/15.1
C1145	4030018090	S.CER C1005 JB 1E 822K-T	B	42.8/20.8
C2001	4050000240	S.FEE NFM18PC104R1C3D	T	39.3/10.9
C2002	4030016930	S.CER C1005 JB 1A 104K-T	B	34.9/5.4
C2004	4550007730	S.TAN TEESVJ 0J 106M8R	B	35.3/7.2
C2007	4030018910	S.CER C1608 JB 0J 475K-T	B	18.4/10.4

[MAIN-B UNIT] (For [High band] versions)

REF NO.	PARTS NO.	DESCRIPTION	M.	H/V LOCATION
C2008	4030016930	S.CER C1005 JB 1A 104K-T	B	16.1/8.9
C2009	4050000240	S.FEE NFM18PC104R1C3D	B	28.0/5.9
C2010	4050000240	S.FEE NFM18PC104R1C3D	B	12.3/5.5
C2011	4030019460	S.CER C1608 JB 0J 106M-T	T	33.0/6.9
C2012	4030016930	S.CER C1005 JB 1A 104K-T	B	26.4/5.8
C2013	4550007730	S.TAN TEESVJ 0J 106M8R	B	25.0/6.2
C2014	4030016930	S.CER C1005 JB 1A 104K-T	T	31.7/6.6
C2015	4030016930	S.CER C1005 JB 1A 104K-T	B	10.1/6.4
C2016	4550007720	S.TAN TEESVJ 0G 476M8R	T	26.7/7.1
C2017	4550007730	S.TAN TEESVJ 0J 106M8R	B	17.2/9.2
C2018	4030016930	S.CER C1005 JB 1A 104K-T	B	9.2/6.4
C2019	4030016930	S.CER C1005 JB 1E 103K-T	B	14.8/19.3
C2021	4030018910	S.CER C1608 JB 0J 475K-T	B	16.0/21.6
C2022	4030018910	S.CER C1608 JB 0J 475K-T	B	13.5/14.5
C2023	4030016790	S.CER C1005 JB 1E 103K-T	B	23.1/14.3
C2024	4030018860	S.CER C1005 JB 0J 105K-T	B	21.2/14.1
C2025	4030017420	S.CER C1005 CH 1H 470J-T	B	20.8/11.1
C2026	4030017460	S.CER C1005 JB 1H 102K-T	B	20.8/10.2
C2027	4030018910	S.CER C1608 JB 0J 475K-T	B	10.9/10.0
C2028	4030018860	S.CER C1005 JB 0J 105K-T	T	11.5/10.2
C2031	4030018860	S.CER C1005 JB 0J 105K-T	T	20.9/11.3
C2032	4030016930	S.CER C1005 JB 1A 104K-T	T	13.1/11.7
C2033	4030018860	S.CER C1005 JB 0J 105K-T	B	15.1/17.7
C2034	4030016930	S.CER C1005 JB 1A 104K-T	T	11.9/7.9
C2035	4030018910	S.CER C1608 JB 0J 475K-T	T	10.2/8.2
C2036	4030018860	S.CER C1005 JB 0J 105K-T	B	21.1/20.9
C2038	4030016790	S.CER C1005 JB 1E 103K-T	B	16.4/25.3
C2039	4030017430	S.CER C1005 CH 1H 101J-T	B	19.7/7.5
C2040	4030016790	S.CER C1005 JB 1E 103K-T	T	26.4/18.1
C2041	4030018910	S.CER C1608 JB 0J 475K-T	T	11.1/14.5
C2042	4030016930	S.CER C1005 JB 1A 104K-T	T	10.1/14.8
C2044	4030016790	S.CER C1005 JB 1E 103K-T	T	26.4/19.9
C2045	4030016930	S.CER C1005 JB 1A 104K-T	B	26.6/23.4
C2046	4030016930	S.CER C1005 JB 1A 104K-T	B	26.6/24.3
C2047	4030016930	S.CER C1005 JB 1A 104K-T	B	26.6/20.7
C2048	4030016930	S.CER C1005 JB 1A 104K-T	B	26.6/22.5
C2049	4030017420	S.CER C1005 CH 1H 470J-T	B	25.7/5.5
C2050	4030017620	S.CER C1005 CH 1H 100C-T	B	26.7/15.8
C2051	4030016930	S.CER C1005 JB 1A 104K-T	B	13.6/29.4
C2052	4030016930	S.CER C1005 JB 1A 104K-T	B	25.5/15.3
C2053	4030017460	S.CER C1005 JB 1H 102K-T	B	27.4/10.8
C2054	4030016930	S.CER C1005 JB 1A 104K-T	T	25.5/12.4
C2055	4030017400	S.CER C1005 CH 1H 220J-T	B	11.0/20.3
C2056	4030017380	S.CER C1005 CH 1H 050B-T	T	27.2/10.7
C2057	4030016930	S.CER C1005 JB 1A 104K-T	B	24.1/10.4
C2058	4030016790	S.CER C1005 JB 1E 103K-T	B	28.8/13.7
C2059	4030017620	S.CER C1005 CH 1H 100C-T	B	18.9/6.2
C2060	4030016780	S.CER C1005 JB 1E 153K-T	B	12.2/11.7
C2062	4030018860	S.CER C1005 JB 0J 105K-T	T	9.4/20.1
C2063	4030017420	S.CER C1005 CH 1H 470J-T	T	2.1/14.7
C2064	4030017420	S.CER C1005 CH 1H 470J-T	T	2.5/13.5
C2065	4030017420	S.CER C1005 CH 1H 470J-T	T	3.8/10.3
C2066	4030017420	S.CER C1005 CH 1H 470J-T	T	6.5/16.5
C2067	4030017420	S.CER C1005 CH 1H 470J-T	T	7.5/24.0
C2068	4030017620	S.CER C1005 CH 1H 100C-T	T	19.5/5.3
C2069	4030017420	S.CER C1005 CH 1H 470J-T	T	27.5/17.2
C2070	4030016930	S.CER C1005 JB 1A 104K-T	B	21.0/12.5
C2071	4030016930	S.CER C1005 JB 1A 104K-T	B	21.7/19.7
C2072	4030016930	S.CER C1005 JB 1A 104K-T	B	17.2/23.8
C2073	4030016930	S.CER C1005 JB 1A 104K-T	B	20.2/16.0
C2074	4030017420	S.CER C1005 CH 1H 470J-T	T	13.1/5.3
C2075	4030017430	S.CER C1005 CH 1H 101J-T	B	18.3/15.9
C2076	4030016930	S.CER C1005 JB 1A 104K-T	T	7.7/27.1
C2077	4030019610	S.CER GRM155B31A105KE15D	B	41.2/6.1
C2078	4030017460	S.CER C1005 JB 1H 102K-T	B	39.8/8.9
C2079	4030017460	S.CER C1005 JB 1H 102K-T	B	38.2/8.9
C2080	4030016790	S.CER C1005 JB 1E 103K-T	B	36.7/5.4
C2081	4550007730	S.TAN TEESVJ 0J 106M8		

[FRONT UNIT]

REF NO.	PARTS NO.	DESCRIPTION	M.	H/V LOCATION
IC6	1130015530	S.IC BU9795AKV-E2	T	59.9/17.4
IC7	1110002751	S.IC TA75S01F(TE85RF)	B	85.8/12.3
IC51	1140015010	S.IC HD64F2506RBR26DV(EMPTY)	B	67.5/21.9
IC52	1130015080	S.IC R1EX24512ASAS0A	B	92.3/15.4
IC53	1130011741	S.IC TC7W66FK(TE85LF)	B	24.3/22.0
IC54	1130007021	S.IC TC7S66FU(TE85LF)	B	28.8/19.5
Q1	1530002851	S.TRA 2SC4116-BL(TE85RF)	B	33.6/16.2
Q2	1590004090	S.TRA LDTCT114YET1G <SLVJ>	B	33.7/19.8
Q5	1590004090	S.TRA LDTCT114YET1G <SLVJ>	B	33.7/22.3
Q10	1590004090	S.TRA LDTCT114YET1G <SLVJ>	B	54.1/21.1
Q95	1590004090	S.TRA LDTCT114YET1G <SLVJ>	B	77.6/11.2
Q96	1590004150	S.TRA DRC9114T0L	B	17.1/12.8
Q97	1590004150	S.TRA DRC9114T0L	B	30.7/21.5
D1	1790001990	S.VAR EZJP0V080DA	T	12.4/17.1
D2	1790001990	S.VAR EZJP0V080DA	T	7.0/17.1
D3	1790001990	S.VAR EZJP0V080DA	B	17.7/10.6
D5	1750002170	S.DIO DB2S31400L [EUR-01]	B	48.6/6.3
	1750002170	S.DIO DB2S31400L [EXP-01]		
	1790001241	S.DIO MA2S7280GL [USA-01]		
	1750002170	S.DIO DB2S31400L [USA-02]		
	1790001241	S.DIO MA2S7280GL [EXP-03]		
	1750002170	S.DIO DB2S31400L [EXP-04]		
	1790001241	S.DIO MA2S7280GL [EXP-06]		
	1750002170	S.DIO DB2S31400L [CHN-01]		
D60	1750001790	S.DIO 1SS390 TE61	B	80.2/13.0
X51	6050013160	S.XTA CR-912 TSS3225A 19.6608 MHz	B	84.0/16.9
L1	6200003640	S.COI MLF1608E 100K-T	B	11.6/17.1
L2	6200001981	S.COI NLV25T-1R0J	B	58.5/9.5
R7	7030005000	S.RES ERJ2GEJ 471 X (470)	B	35.7/16.2
R8	7030005000	S.RES ERJ2GEJ 471 X (470)	B	36.7/16.2
R9	7030007570	S.RES ERJ2GEJ 122 X (1.2K)	B	37.6/16.2
R11	7030009280	S.RES ERJ2GEJ 391 X	B	33.1/18.0
R12	7030009140	S.RES ERJ2GEJ 272 X (2.7K)	B	34.7/18.0
R14	7210003330	VAR RK09D1130A1N		
R15	7030005120	S.RES ERJ2GEJ 102 X (1K)	B	7.2/17.1
R16	7030005120	S.RES ERJ2GEJ 102 X (1K)	B	15.5/12.0
R18	7030005240	S.RES ERJ2GEJ 473 X (47K)	T	5.9/17.1
R19	7030005090	S.RES ERJ2GEJ 104 X (100K)	B	18.7/12.6
R20	7030010040	S.RES ERJ2GEJ-JPW	B	29.7/7.3
R40	7030005040	S.RES ERJ2GEJ 472 X (4.7K)	B	23.0/25.4
R41	7030007340	S.RES ERJ2GEJ 153 X (15K)	B	23.0/27.4
R42	7030005240	S.RES ERJ2GEJ 473 X (47K)	B	26.9/27.8
R43	7030007350	S.RES ERJ2GEJ 393 X (39K)	B	28.8/27.8
R44	7030005170	S.RES ERJ2GEJ 474 X (470K)	B	25.0/26.2
R46	7030004980	S.RES ERJ2GEJ 101 X (100)	B	33.4/3.3
R47	7030007300	S.RES ERJ2GEJ 332 X (3.3K)	B	33.4/5.1
R51	7030005090	S.RES ERJ2GEJ 104 X (100K)	B	51.0/6.3
R60	7030005090	S.RES ERJ2GEJ 104 X (100K)	B	84.0/8.6
R76	7030005120	S.RES ERJ2GEJ 102 X (1K)	T	10.4/17.1
R83	7030005090	S.RES ERJ2GEJ 104 X (100K)	B	40.0/14.7
R85	7030005090	S.RES ERJ2GEJ 104 X (100K)	B	57.7/27.5
R86	7030005090	S.RES ERJ2GEJ 104 X (100K)	B	56.7/25.0
R87	7030005090	S.RES ERJ2GEJ 104 X (100K)	B	59.1/28.1
R88	7030005090	S.RES ERJ2GEJ 104 X (100K)	B	56.3/6.9
R89	7030005090	S.RES ERJ2GEJ 104 X (100K)	B	86.9/19.8
R90	7030005090	S.RES ERJ2GEJ 104 X (100K)	B	86.2/26.0
R243	7030005530	S.RES ERJ2GEJ 100 X (10)	B	80.5/18.4
R244	7030005160	S.RES ERJ2GEJ 105 X (1M)	B	81.9/17.9
R627	7030005090	S.RES ERJ2GEJ 104 X (100K)	B	74.8/17.5
R628	7030005090	S.RES ERJ2GEJ 104 X (100K)	B	58.1/5.6
R631	7030005050	S.RES ERJ2GEJ 103 X (10K)	B	80.8/15.5
R632	7030005050	S.RES ERJ2GEJ 103 X (10K)	B	81.7/13.7
R633	7030005040	S.RES ERJ2GEJ 472 X (4.7K)	B	77.6/12.7
R635	7030005050	S.RES ERJ2GEJ 103 X (10K)	B	86.0/11.0
R636	7030005050	S.RES ERJ2GEJ 103 X (10K)	B	86.6/9.8
R637	7030005120	S.RES ERJ2GEJ 102 X (1K)	B	55.0/24.4
R638	7030005090	S.RES ERJ2GEJ 104 X (100K)	B	77.8/23.8
R639	7030005090	S.RES ERJ2GEJ 104 X (100K)	B	76.6/16.3
R651	7030005120	S.RES ERJ2GEJ 102 X (1K)	B	88.4/9.8
R652	7030005120	S.RES ERJ2GEJ 102 X (1K)	B	70.9/29.6
R657	7030005120	S.RES ERJ2GEJ 102 X (1K)	B	86.0/12.2
R688	7030005120	S.RES ERJ2GEJ 102 X (1K)	B	81.8/22.3
R763	7410001150	S.ARR EXB28V471JX	B	76.0/14.5
R765	7410001130	S.ARR EXB28V102JX	B	63.1/29.6
R767	7410001130	S.ARR EXB28V102JX	B	59.2/24.8
R768	7410001130	S.ARR EXB28V102JX	B	59.2/21.7
R769	7410001130	S.ARR EXB28V102JX	B	59.3/18.0
R770	7410001130	S.ARR EXB28V102JX	B	75.8/26.3
R771	7410001130	S.ARR EXB28V102JX	B	69.4/12.7
R772	7410001130	S.ARR EXB28V102JX	B	77.3/19.1
R773	7030005120	S.RES ERJ2GEJ 102 X (1K)	B	83.4/28.7
R774	7030005120	S.RES ERJ2GEJ 102 X (1K)	B	86.5/23.2
R775	7030005090	S.RES ERJ2GEJ 104 X (100K)	B	59.2/5.6
R776	7030005090	S.RES ERJ2GEJ 104 X (100K)	B	56.0/19.8
R777	7030005090	S.RES ERJ2GEJ 104 X (100K)	B	82.3/23.8
R778	7030005090	S.RES ERJ2GEJ 104 X (100K)	B	76.5/17.2
R779	7030005090	S.RES ERJ2GEJ 104 X (100K)	B	67.3/29.3
R780	7030005210	S.RES ERJ2GEJ 822 X (8.2K)	B	23.0/29.4
R781	7030007340	S.RES ERJ2GEJ 153 X (15K)	B	23.0/28.4
R782	7030005090	S.RES ERJ2GEJ 104 X (100K)	B	75.6/22.7
R783	7030005090	S.RES ERJ2GEJ 104 X (100K)	B	58.5/29.4
R784	7030005240	S.RES ERJ2GEJ 473 X (47K)	B	26.5/18.8
R785	7030005240	S.RES ERJ2GEJ 473 X (47K)	B	30.8/19.3

[FRONT UNIT]

REF NO.	PARTS NO.	DESCRIPTION	M.	H/V LOCATION
C2	4030017420	S.CER C1005 CH 1H 470J-T	B	84.0/7.7
C3	4030017420	S.CER C1005 CH 1H 470J-T	B	28.5/6.1
C4	4030017420	S.CER C1005 CH 1H 470J-T	B	47.2/5.0
C5	4030017420	S.CER C1005 CH 1H 470J-T	B	56.3/4.6
C8	4030017460	S.CER C1005 JB 1H 102K-T	B	13.7/17.1
C9	4030017460	S.CER C1005 JB 1H 102K-T	T	11.3/17.1
C10	4030017460	S.CER C1005 JB 1H 102K-T	T	20.3/13.1
C12	4030017460	S.CER C1005 JB 1H 102K-T	T	18.3/13.1
C25	4030016970	S.CER C1005 JB 1E 103K-T	B	26.9/28.9
C26	4030016930	S.CER C1005 JB 1A 104K-T	B	23.0/26.4
C27	4030017680	S.CER C1005 CH 1H 820J-T	B	25.0/27.1
C28	4030016930	S.CER C1005 JB 1A 104K-T	B	30.6/27.1
C31	4030016930	S.CER C1005 JB 1A 104K-T	B	33.4/4.2
C34	4030017420	S.CER C1005 CH 1H 470J-T	B	56.3/5.5
C41	4030017460	S.CER C1005 JB 1H 102K-T	B	25.0/29.0
C50	4030017420	S.CER C1005 CH 1H 470J-T	B	61.6/8.6
C75	4030016930	S.CER C1005 JB 1A 104K-T	B	43.8/14.7
C76	4030016930	S.CER C1005 JB 1A 104K-T	B	28.8/28.9
C78	4030017460	S.CER C1005 JB 1H 102K-T	B	8.9/17.1
C84	4030017420	S.CER C1005 CH 1H 470J-T	B	29.9/2.9
C87	4030016930	S.CER C1005 JB 1A 104K-T	B	30.9/18.0
C93	4030017460	S.CER C1005 JB 1H 102K-T	B	56.3/7.9
C114	4030017420	S.CER C1005 CH 1H 470J-T	B	19.7/10.6
C126	4030017460	S.CER C1005 JB 1H 102K-T	B	25.2/4.2
C128	4030016930	S.CER C1005 JB 1A 104K-T	T	14.6/19.3
C129	4030017460	S.CER C1005 JB 1H 102K-T	T	13.7/19.3
C130	4030017460	S.CER C1005 JB 1H 102K-T	B	85.7/8.6
C131	4030017460	S.CER C1005 JB 1H 102K-T	B	86.9/21.0
C132	4030017460	S.CER C1005 JB 1H 102K-T	B	86.2/26.9
C626	4030017640	S.CER C1005 CH 1H 150J-T	B	81.1/19.6
C627	4030017580	S.CER C1005 CH 1H 060C-T	B	80.0/17.0
C628	4030017640	S.CER C1005 CH 1H 150J-T	B	81.0/17.0
C629	4030016930	S.CER C1005 JB 1A 104K-T	B	79.4/15.1
C630	4030016930	S.CER C1005 JB 1A 104K-T	B	76.2/12.3
C631	4030016930	S.CER C1005 JB 1A 104K-T	B	56.1/29.6
C797	4030016930	S.CER C1005 JB 1A 104K-T	B	75.6/21.5
C799	4030016930	S.CER C1005 JB 1A 104K-T	B	77.2/22.4
C800	4030016930	S.CER C1005 JB 1A 104K-T	B	77.2/21.2
C802	4030016930	S.CER C1005 JB 1A 104K-T	B	64.7/9.9
C803	4030019990	S.CER C1005 JB 1C 104K-T	B	49.7/24.9
C804	4030017460	S.CER C1005 JB 1H 102K-T	B	26.6/22.1
C805	4030018900	S.CER C1005 JB 0J 474K-T	B	65.3/29.3
C806	4550008240	S.TAN F930G476MAA [EUR-01]	B	43.4/6.5
	4550006970	S.TAN TEESVA 0G 476M8R [EXP-01]		
	4550008240	S.TAN F930G476MAA [USA-01]		
	4550006970	S.TAN TEESVA 0G 476M8R [USA-02]		
	4550008240	S.TAN F930G476MAA [EXP-03]		
	4550006970	S.TAN TEESVA 0G 476M8R [EXP-04]		
	4550006970	S.TAN TEESVA 0G 476M8R [EXP-06]		
	4550008240	S.TAN F930G476MAA [CHN-01]		
C807	4030016930	S.CER C1005 JB 1A 104K-T	B	75.4/20.4
C808	4030016930	S.CER C1005 JB 1A 104K-T	B	78.8/17.1
C809	4030016930	S.CER C1005 JB 1A 104K-T	B	88.6/15.1
C810	4030016930	S.CER C1005 JB 1A 104K-T	B	25.0/28.1
C811	4030017460	S.CER C1005 JB 1H 102K-T	B	31.5/8.0
J2	6450002210	CON 3017-8821 <KIN>		
J2	6510027960	S.CON 04-6294-040-000-800	B	71.0/5.7
J3	6510025142	S.CON 10FLT-SM2-TB(LF)(SN)(M)	B	51.6/28.5
DS1	5040003510	S.LED LNJ426W83RA	T	64.8/23.5
DS2	5040003510	S.LED LNJ426W83RA	T	58.2/23.5
DS3	5040003510	S.LED LNJ426W83RA	T	51.6/23.5
DS4	5040003510	S.LED LNJ426W83RA	T	31.8/23.5
DS5	5040003510	S.LED LNJ426W83RA	T	38.4/23.5
DS6	5040003510	S.LED LNJ426W83RA	T	45.0/23.5
DS7	5040003510	S.LED LNJ426W83RA	T	82.6/22.1
DS8	5040003510	S.LED LNJ426W83RA	T	65.3/5.0
DS9	5040003510	S.LED LNJ426W83RA	T	36.3/5.0
DS11	5030003390	LCD TAK-35877 FX-3331<ITAK>		
SP1	2510001221	SPE C052SB500-14 <OSC>		
W1	8900010503	CAB OPC-1046B-1(P0.5N40L55) <TJM>		
EP2	8930059170	LCD SRCN-2622-SP-N-W (SHJ)		

M.=Mounted side (T: Mounted on the Top side, B: Mounted on the Bottom side)
S.=Surface mount

[MAIN-C UNIT] (For [350 MHz band] versions)

REF NO.	PARTS NO.	DESCRIPTION	M.	H/V LOCATION
R48	7030008300	S.RES ERJ2GGEJ 184 X (180K)	T	56.8/53.2
R49	7520000241	S.POS PRF18BC471QBSRB	T	47.3/53.2
R50	7030005050	S.RES ERJ2GGEJ 103 X (10K)	B	80.1/37.9
R51	7030005080	S.RES ERJ2GGEJ 823 X (82K)	T	61.8/49.8
R52	7030005070	S.RES ERJ2GGEJ 683 X (68K)	T	58.7/52.1
R53	7030004990	S.RES ERJ2GGEJ 221 X (220)	T	57.8/53.2
R54	7030005220	S.RES ERJ2GGEJ 223 X (22K)	B	58.8/55.7
R56	7030005110	S.RES ERJ2GGEJ 224 X (220K)	T	63.3/55.0
R57	7030005050	S.RES ERJ2GGEJ 103 X (10K)	B	58.8/54.8
R58	7030005570	S.RES ERJ2GGEJ 820 X (82)	T	64.2/55.0
R59	7030007350	S.RES ERJ2GGEJ 393 X (39K)	T	59.7/52.1
R61	7030004970	S.RES ERJ2GGEJ 470 X (47)	B	90.5/49.5
R62	7030008290	S.RES ERJ2GGEJ 183 X (18K)	B	89.6/49.5
R66	7030005090	S.RES ERJ2GGEJ 104 X (100K)	B	84.9/49.1
R67	7030004980	S.RES ERJ2GGEJ 101 X (100)	B	83.0/47.3
R68	7030005050	S.RES ERJ2GGEJ 103 X (10K)	B	82.6/48.7
R69	7030005040	S.RES ERJ2GGEJ 472 X (4.7K)	B	84.0/38.0
R70	7030004990	S.RES ERJ2GGEJ 221 X (220)	B	92.8/35.8
R71	7030007260	S.RES ERJ2GGEJ 330 X (33)	B	95.3/33.8
R72	7030004980	S.RES ERJ2GGEJ 101 X (100)	B	86.5/49.1
R73	7030004980	S.RES ERJ2GGEJ 101 X (100)	B	99.5/35.3
R74	7030005080	S.RES ERJ2GGEJ 823 X (82K)	B	101.3/33.7
R75	7030005720	S.RES ERJ2GGEJ 563 X (56K)	B	97.6/32.2
R76	7030005030	S.RES ERJ2GGEJ 152 X (1.5K)	B	96.7/32.2
R77	7030005120	S.RES ERJ2GGEJ 102 X (1K)	T	105.6/36.0
R78	7030009270	S.RES ERJ2GGEJ 821 X (820)	T	102.5/32.5
R79	7030006020	S.RES RR0510P-682-D (6.8K)	B	96.5/23.7
R80	7030005120	S.RES ERJ2GGEJ 102 X (1K)	T	100.0/32.5
R83	7030006020	S.RES RR0510P-682-D (6.8K)	B	106.4/29.1
R84	7030006020	S.RES RR0510P-682-D (6.8K)	B	106.4/28.2
R85	7030006020	S.RES RR0510P-682-D (6.8K)	B	95.6/25.3
R86	7030005110	S.RES ERJ2GGEJ 224 X (220K)	B	102.6/24.4
R87	7030005530	S.RES ERJ2GGEJ 100 X (10)	B	102.6/27.5
R89	7030005050	S.RES ERJ2GGEJ 103 X (10K)	T	79.0/25.0
R90	7030005170	S.RES ERJ2GGEJ 474 X (470K)	T	95.9/13.3
R92	7030005100	S.RES ERJ2GGEJ 154 X (150K)	T	94.3/14.4
R93	7030005600	S.RES ERJ2GGEJ 273 X (27K)	B	81.3/25.8
R95	7030005710	S.RES ERJ2GGEJ 121 X (120)	B	83.8/24.5
R96	7030008400	S.RES ERJ2GGEJ 182 X (1.8K)	B	83.8/23.5
R97	7030010040	S.RES ERJ2GGEJ-JPW	B	82.2/24.5
R98	7030007290	S.RES ERJ2GGEJ 222 X (2.2K)	T	109.5/33.8
R100	7030005240	S.RES ERJ2GGEJ 473 X (47K)	T	76.1/20.3
R101	7030004980	S.RES ERJ2GGEJ 101 X (100)	T	77.9/22.2
R123	7030005530	S.RES ERJ2GGEJ 100 X (10)	T	68.2/40.4
R125	7030008370	S.RES ERJ2GGEJ 561 X (560)	T	65.6/29.2
R171	7030004980	S.RES ERJ2GGEJ 101 X (100)	T	45.5/28.6
R172	7030008300	S.RES ERJ2GGEJ 184 X (180K)	T	44.2/27.1
R173	7030005120	S.RES ERJ2GGEJ 102 X (1K)	T	42.9/26.4
R174	7030005290	S.RES ERJ2GGEJ 682 X (6.8K)	T	42.0/28.8
R175	7030009290	S.RES ERJ2GGEJ 562 X (5.6K)	T	41.6/27.6
R176	7030005030	S.RES ERJ2GGEJ 152 X (1.5K)	T	42.0/26.4
R178	7030004970	S.RES ERJ2GGEJ 470 X (47)	B	39.8/24.4
R211	7030004970	S.RES ERJ2GGEJ 470 X (47)	B	82.7/28.3
R212	7030010040	S.RES ERJ2GGEJ-JPW	B	82.6/60.4
R234	7030005070	S.RES ERJ2GGEJ 683 X (68K)	B	92.8/34.9
R235	7030004980	S.RES ERJ2GGEJ 101 X (100)	B	81.0/37.9
R236	7030007570	S.RES ERJ2GGEJ 122 X (1.2K)	B	67.4/22.7
R237	7030007060	S.RES ERJ2GGEJ 684X (680K)	B	67.4/23.6
R289	7030005090	S.RES ERJ2GGEJ 104 X (100K)	T	95.9/12.6
R290	7030005010	S.RES ERJ2GGEJ 681 X (680)	T	63.2/23.1
R291	7030005090	S.RES ERJ2GGEJ 104 X (100K)	T	94.3/13.5
R293	7030006610	S.RES ERJ2GGEJ 394 X (390K)	T	88.4/12.0
R295	7030006610	S.RES ERJ2GGEJ 394 X (390K)	T	101.0/17.3
R299	7030008300	S.RES ERJ2GGEJ 184 X (180K)	B	74.6/38.5
R300	7030005720	S.RES ERJ2GGEJ 563 X (56K)	B	76.8/40.6
R301	7030005100	S.RES ERJ2GGEJ 154 X (150K)	B	67.5/40.5
R302	7030005720	S.RES ERJ2GGEJ 563 X (56K)	B	66.9/38.3
R308	7030009140	S.RES ERJ2GGEJ 272 X (2.7K)	T	56.9/54.9
R311	7030010040	S.RES ERJ2GGEJ-JPW	B	94.9/32.2
R317	7030005120	S.RES ERJ2GGEJ 102 X (1K)	T	105.6/37.4
R319	7030007340	S.RES ERJ2GGEJ 153 X (15K)	T	37.3/37.9
R320	7030005170	S.RES ERJ2GGEJ 474 X (470K)	T	35.5/36.2
R328	7030010040	S.RES ERJ2GGEJ-JPW	B	104.8/29.1
R334	7030007280	S.RES ERJ2GGEJ 331 X (330)	T	87.6/61.3
R337	7030005300	S.RES ERJ2GGEJ 150 X (15)	T	87.1/62.7
R338	7030007280	S.RES ERJ2GGEJ 331 X (330)	T	87.6/64.1
R339	7030010040	S.RES ERJ2GGEJ-JPW	B	96.5/25.3
R340	7030005050	S.RES ERJ2GGEJ 103 X (10K)	B	72.4/25.3
R350	7030005600	S.RES ERJ2GGEJ 273 X (27K)	B	52.9/26.2
R351	7030005600	S.RES ERJ2GGEJ 273 X (27K)	B	43.2/26.3
R352	7030007300	S.RES ERJ2GGEJ 332 X (3.3K)	B	50.9/26.8
R353	7030005210	S.RES ERJ2GGEJ 822 X (8.2K)	B	45.4/27.3
R354	7030005210	S.RES ERJ2GGEJ 822 X (8.2K)	B	46.1/29.0
R394	7030010040	S.RES ERJ2GGEJ-JPW	B	100.1/27.3
R395	7030010040	S.RES ERJ2GGEJ-JPW	B	26.7/46.8
R478	7030007340	S.RES ERJ2GGEJ 153 X (15K)	B	35.5/26.8
R479	7030005600	S.RES ERJ2GGEJ 273 X (27K)	T	66.8/27.4
R483	7030007300	S.RES ERJ2GGEJ 332 X (3.3K)	T	71.5/28.8
R484	7030007300	S.RES ERJ2GGEJ 332 X (3.3K)	T	76.5/42.5
R485	7030010040	S.RES ERJ2GGEJ-JPW	T	77.0/40.4
R486	7030005000	S.RES ERJ2GGEJ 471 X (470)	T	73.2/29.7
R488	7030007300	S.RES ERJ2GGEJ 332 X (3.3K)	T	68.6/42.5
R489	7030007300	S.RES ERJ2GGEJ 332 X (3.3K)	T	68.5/29.7
R490	7030005120	S.RES ERJ2GGEJ 102 X (1K)	T	81.3/42.2
R492	7030005090	S.RES ERJ2GGEJ 104 X (100K)	B	80.0/27.2
R500	7030010040	S.RES ERJ2GGEJ-JPW	B	49.8/16.5
R504	7030005090	S.RES ERJ2GGEJ 104 X (100K)	T	75.3/17.9
R505	7030005290	S.RES ERJ2GGEJ 682 X (6.8K)	T	76.1/22.7
R506	7030005050	S.RES ERJ2GGEJ 103 X (10K)	T	74.8/21.5
R613	7030005120	S.RES ERJ2GGEJ 102 X (1K)	T	81.2/39.3
R614	7030005030	S.RES ERJ2GGEJ 152 X (1.5K)	B	56.2/24.3
R615	7030005040	S.RES ERJ2GGEJ 472 X (4.7K)	T	50.7/27.7
R616	7030008300	S.RES ERJ2GGEJ 184 X (180K)	B	59.9/19.6
R617	7030005090	S.RES ERJ2GGEJ 104 X (100K)	B	57.4/15.8
R618	7030004980	S.RES ERJ2GGEJ 101 X (100)	B	62.1/16.9

[MAIN-C UNIT] (For [350 MHz band] versions)

REF NO.	PARTS NO.	DESCRIPTION	M.	H/V LOCATION
R619	7030005030	S.RES ERJ2GGEJ 152 X (1.5K)	B	36.0/27.5
R620	7030005240	S.RES ERJ2GGEJ 473 X (4.7K)	B	57.4/18.4
R621	7410001130	S.ARR EXB28V102JX	B	76.6/19.6
R622	7030007570	S.RES ERJ2GGEJ 122 X (1.2K)	B	83.8/21.6
R623	7030005090	S.RES ERJ2GGEJ 104 X (100K)	T	50.7/26.1
R624	7030005040	S.RES ERJ2GGEJ 104 X (100K)	T	83.2/11.6
R625	7030010090	S.RES ERJ2GGEJ-JPW	B	96.1/20.1
R1003	7030007601	S.RES ERA3YKD 913V (91K)	B	72.6/9.4
R1004	7030006101	S.RES ERA3YED 183V (18K)	B	70.2/10.2
R1005	7030005120	S.RES ERJ2GGEJ 102 X (1K)	T	112.3/16.5
R1006	7030005090	S.RES ERJ2GGEJ 104 X (100K)	B	112.4/8.1
R1008	7030001040	S.RES ERJ2GGEJ-JPW	T	124.9/24.8
R1009	7030005050	S.RES ERJ2GGEJ 103 X (10K)	T	133.3/49.2
R1010	7030005050	S.RES ERJ2GGEJ 103 X (10K)	T	128.6/23.8
R1012	7030005040	S.RES ERJ2GGEJ 472 X (4.7K)	T	110.6/46.0
R1013	7030005240	S.RES ERJ2GGEJ 473 X (4.7K)	T	114.7/49.0
R1014	7030005090	S.RES ERJ2GGEJ 104 X (100K)	T	98.3/12.1
R1015	7030005120	S.RES ERJ2GGEJ 102 X (1K)	B	115.3/22.8
R1016	7030005090	S.RES ERJ2GGEJ 104 X (100K)	B	115.6/6.1
R1018	7030005090	S.RES ERJ2GGEJ 104 X (100K)	T	111.7/7.0
R1020	7030005090	S.RES ERJ2GGEJ 104 X (100K)	B	114.7/24.9
R1021	7030005120	S.RES ERJ2GGEJ 102 X (1K)	B	116.5/6.1
R1022	7030005120	S.RES ERJ2GGEJ 102 X (1K)	T	114.9/7.1
R1023	7030005050	S.RES ERJ2GGEJ 103 X (10K)	B	125.2/15.7
R1024	7030007290	S.RES ERJ2GGEJ 222 X (2.2K)	B	131.6/17.6
R1025	7030000480	S.RES MCR10EZHJ 6.8K (682)	B	129.4/47.0
R1026	7030000480	S.RES MCR10EZHJ 6.8K (682)	B	129.4/48.8
R1027	7030010040	S.RES ERJ2GGEJ-JPW	T	113.7/16.5
R1028	7030004970	S.RES ERJ2GGEJ 470 X (47)	B	114.9/13.4
R1029	7030005120	S.RES ERJ2GGEJ 102 X (1K)	T	115.3/10.5
R1030	7030005050	S.RES ERJ2GGEJ 103 X (10K)	T	114.4/10.5
R1031	7030005050	S.RES ERJ2GGEJ 103 X (10K)	B	117.8/7.7
R1032	7030005050	S.RES ERJ2GGEJ 103 X (10K)	B	127.1/19.9
R1033	7030000480	S.RES MCR10EZHJ 6.8K (682)	B	129.4/45.2
R1034	7030005040	S.RES ERJ2GGEJ 472 X (4.7K)	B	123.6/17.5
R1035	7030005050	S.RES ERJ2GGEJ 103 X (10K)	T	107.8/42.5
R1036	7030005040	S.RES ERJ2GGEJ 472 X (4.7K)	T	107.8/41.2
R1037	7030005090	S.RES ERJ2GGEJ 104 X (100K)	T	95.9/13.5
R1038	7030005120	S.RES ERJ2GGEJ 102 X (1K)	B	125.6/36.3
R1039	7030005090	S.RES ERJ2GGEJ 104 X (100K)	B	113.7/12.9
R1040	7030005160	S.RES ERJ2GGEJ 105 X (1M)	T	111.2/19.9
R1043	7030005160	S.RES ERJ2GGEJ 105 X (1M)	B	112.0/11.0
R1044	7030005090	S.RES ERJ2GGEJ 104 X (100K)	B	117.9/9.9
R1045	7030005050	S.RES ERJ2GGEJ 103 X (10K)	B	120.4/17.1
R1046	7030005800	S.RES RR0510P-102-D (1K)	B	119.7/0.0
R1047	7030005050	S.RES ERJ2GGEJ 103 X (10K)	B	119.4/18.6
R1048	7030009710	S.RES ERJ2GGEJ 203 X (20K)	B	119.0/22.4
R1049	7030005040	S.RES ERJ2GGEJ 472 X (4.7K)	B	116.7/19.7
R1050	7030007290	S.RES ERJ2GGEJ 222 X (2.2K)	B	123.0/38.1
R1054	7030008270	S.RES RR0510P-104-D (100K)	B	119.7/9.9
R1055	7030005090	S.RES ERJ2GGEJ 104 X (100K)	B	120.4/15.2
R1056	7030008270	S.RES RR0510P-104-D (100K)	B	118.8/10.8
R1057	7030005100	S.RES ERJ2GGEJ 154 X (15K)	B	118.8/15.2
R1059	7410001130	S.ARR EXB28V102JX	T	69.7/14.8
R1060	7410001130	S.ARR EXB28V102JX	T	63.4/14.8
R1062	7030008270	S.RES RR0510P-104-D (100K)	B	116.0/14.8
R1063	7030007340	S.RES ERJ2GGEJ 153 X (15K)	B	42.8/22.4
R1064	7030005090	S.RES ERJ2GGEJ 104 X (100K)	T	40.5/23.1
R1068	7030005120	S.RES ERJ2GGEJ 102 X (1K)	T	74.3/14.1
R1069	7030005120	S.RES ERJ2GGEJ 102 X (1K)	T	72.6/14.1
R1070	7030005120	S.RES ERJ2GGEJ 102 X (1K)	T	57.3/15.1
R1071	7030005090	S.RES ERJ2GGEJ 104 X (100K)	T	51.7/16.7
R1072	7030005040	S.RES ERJ2GGEJ 472 X (4.7K)	T	52.9/16.3
R1073	7030005700	S.RES ERJ2GGEJ 274 X (270K)	B	50.8/18.7
R1074	7030005100	S.RES ERJ2GGEJ 154 X (15K)	T	32.7/20.6
R1075	7030008010	S.RES ERJ2GGEJ 123 X (12K)	T	36.3/21.5
R1076	7030005090	S.RES ERJ2GGEJ 104 X (100K)	B	35.0/20.5
R1077	7030005170	S.RES ERJ2GGEJ 474 X (470K)	B	36.6/20.2
R1078	7030005090	S.RES ERJ2GGEJ 104 X (100K)	B	32.2/15.2
R1080	7030005310	S.RES ERJ2GGEJ 124 X (120K)	B	40.1/13.5
R1081	7030008290	S.RES ERJ2GGEJ 183 X (18K)	T	42.5/19.5
R1082	7410001130	S.ARR EXB28V102JX	T	56.9/7.6
R1083				

[MAIN-C UNIT] (For [350 MHz band] versions)

REF NO.	PARTS NO.	DESCRIPTION	M.	H/V LOCATION
R2004	7030005210	S.RES ERJ2GEJ 822 X (8.2K)	B	12.6/8.8
R2005	7030005210	S.RES ERJ2GEJ 822 X (8.2K)	B	15.8/6.8
R2009	7030007290	S.RES ERJ2GEJ 222 X (2.2K)	B	10.5/11.7
R2010	7030004980	S.RES ERJ2GEJ 101 X (100)	T	11.5/11.7
R2011	7030004980	S.RES ERJ2GEJ 101 X (100)	T	23.0/10.4
R2012	7030004980	S.RES ERJ2GEJ 101 X (100)	T	22.5/11.3
R2013	7030005240	S.RES ERJ2GEJ 473 X (47K)	B	19.8/12.0
R2015	7030005240	S.RES ERJ2GEJ 473 X (47K)	T	18.4/11.6
R2016	7030010040	S.RES ERJ2GEJ-JPW	B	24.0/5.8
R2019	7030010040	S.RES ERJ2GEJ-JPW	B	9.9/17.9
R2020	7030010040	S.RES ERJ2GEJ-JPW	B	14.4/11.1
R2021	7030004980	S.RES ERJ2GEJ 101 X (100)	B	23.6/12.1
R2022	7030004980	S.RES ERJ2GEJ 101 X (100)	B	27.9/24.7
R2024	7030005240	S.RES ERJ2GEJ 473 X (47K)	B	26.6/21.6
R2026	7030004970	S.RES ERJ2GEJ 470 X (47)	B	27.9/22.9
R2028	7030005240	S.RES ERJ2GEJ 473 X (47K)	B	12.1/19.3
R2030	7030005240	S.RES ERJ2GEJ 473 X (47K)	B	11.0/21.2
R2031	7030005240	S.RES ERJ2GEJ 473 X (47K)	B	10.7/29.4
R2032	7030005240	S.RES ERJ2GEJ 473 X (47K)	B	24.9/17.4
R2034	7030005240	S.RES ERJ2GEJ 473 X (47K)	B	28.8/10.5
R2035	7030005240	S.RES ERJ2GEJ 473 X (47K)	B	26.7/14.9
R2036	7030004980	S.RES ERJ2GEJ 101 X (100)	T	26.8/11.9
R2037	7030007290	S.RES ERJ2GEJ 222 X (2.2K)	T	28.1/10.7
R2038	7030004970	S.RES ERJ2GEJ 470 X (47)	B	28.8/12.1
R2039	7030005240	S.RES ERJ2GEJ 473 X (47K)	B	24.1/9.5
R2040	7030005240	S.RES ERJ2GEJ 473 X (47K)	B	24.5/12.1
R2043	7410001140	S.ARR EXB28V104JX	T	15.6/26.7
R2044	7410001140	S.ARR EXB28V104JX	B	20.8/26.3
R2045	7410001140	S.ARR EXB28V104JX	T	27.0/22.6
R2046	7410001140	S.ARR EXB28V104JX	T	19.3/26.7
R2047	7410001140	S.ARR EXB28V104JX	B	10.9/14.5
R2048	7030005090	S.RES ERJ2GEJ 104 X (100K)	T	25.7/14.6
R2049	7030005090	S.RES ERJ2GEJ 104 X (100K)	B	21.8/15.6
R2050	7410001140	S.ARR EXB28V104JX	B	22.6/18.2
R2051	7410001140	S.ARR EXB28V104JX	T	9.9/17.6
R2052	7030005090	S.RES ERJ2GEJ 104 X (100K)	T	16.8/11.6
R2053	7030005090	S.RES ERJ2GEJ 104 X (100K)	T	16.0/14.5
R2056	7030010040	S.RES ERJ2GEJ-JPW	B	10.6/20.0
R2057	7030005090	S.RES ERJ2GEJ 104 X (100K)	T	10.4/22.9
R2058	7410001140	S.ARR EXB28V104JX	B	17.0/18.6
R2059	7030005090	S.RES ERJ2GEJ 104 X (100K)	T	10.4/23.8
R2060	7030005090	S.RES ERJ2GEJ 104 X (100K)	T	25.7/15.6
R2061	7030005090	S.RES ERJ2GEJ 104 X (100K)	B	14.7/12.6
R2062	7030005090	S.RES ERJ2GEJ 104 X (100K)	B	17.7/14.4
R2063	7030005090	S.RES ERJ2GEJ 104 X (100K)	B	22.1/23.4
R2064	7030005090	S.RES ERJ2GEJ 104 X (100K)	B	19.7/17.7
R2065	7030005030	S.RES ERJ2GEJ 152 X (1.5K)	B	13.8/6.8
R2066	7410001170	S.ARR EXB28V470JX	T	21.3/6.7
R2067	7030010040	S.RES ERJ2GEJ-JPW	T	11.4/5.3
R2068	7030010040	S.RES ERJ2GEJ-JPW	T	20.9/10.4
R2071	7030010040	S.RES ERJ2GEJ-JPW	T	24.9/5.7
R2072	7030005050	S.RES ERJ2GEJ 103 X (10K)	B	12.2/10.1
R2074	7030010040	S.RES ERJ2GEJ-JPW	T	8.7/10.0
R2084	7030010040	S.RES ERJ2GEJ-JPW	T	30.7/10.5
R2085	7030010040	S.RES ERJ2GEJ-JPW	B	19.5/9.6
C1	4030011080	S.CER GRM31M2C2H6R0DV01L (GRM42-6 CH)	B	8.4/66.6
C2	4030011080	S.CER GRM31M2C2H6R0DV01L (GRM42-6 CH)	B	7.4/58.6
C3	4030009500	S.CER C1608 CH 1H 0R5B-T	B	25.6/51.9
C4	4030009500	S.CER C1608 CH 1H 0R5B-T	B	16.4/51.9
C5	4030009500	S.CER C1608 CH 1H 0R5B-T	B	8.2/54.5
C6	4030011100	S.CER GRM31M2C2H8R0DV01L (GRM42-6 CH)	B	7.4/56.3
C7	4030011110	S.CER GRM31M2C2H9R0DV01L (GRM42-6 CH)	B	13.1/60.7
C8	4030011100	S.CER GRM31M2C2H8R0DV01L (GRM42-6 CH)	B	19.5/60.7
C9	4030011100	S.CER GRM31M2C2H8R0DV01L (GRM42-6 CH)	T	30.6/53.1
C10	4030017730	S.CER C1005 JB 1H 471K-T	B	18.1/48.1
C11	4030017730	S.CER C1005 JB 1H 471K-T	B	10.0/49.2
C12	4030017730	S.CER C1005 JB 1H 471K-T	T	39.4/54.4
C13	4030017420	S.CER C1005 CH 1H 470J-T	B	49.5/51.4
C14	4030019420	S.CER GRM31A7U2J102JW31D	B	34.9/55.5
C15	4030017360	S.CER C1005 CH 1H 030B-T	T	23.7/50.4
C20	4030017670	S.CER C1005 CH 1H 390J-T	B	30.6/40.5
C21	4030017580	S.CER C1005 CH 1H 060C-T	B	26.7/38.1
C22	4030017560	S.CER C1005 CH 1H 2R5B-T	B	32.0/37.5
C25	4030017420	S.CER C1005 CH 1H 470J-T	B	25.8/38.1
C26	4030017670	S.CER C1005 CH 1H 390J-T	B	33.4/40.5
C27	4030016930	S.CER C1005 JB 1A 104K-T	B	31.5/38.8
C28	4030017460	S.CER C1005 JB 1H 102K-T	B	42.5/36.2
C29	4030017600	S.CER C1005 CH 1H 080C-T	B	37.1/37.4
C30	4030017630	S.CER C1005 CH 1H 120J-T	B	39.2/37.7
C31	4030016930	S.CER C1005 JB 1A 104K-T	B	51.5/37.4
C32	4030017460	S.CER C1005 JB 1H 102K-T	B	41.3/40.7
C33	4030017420	S.CER C1005 CH 1H 470J-T	B	38.6/40.7
C34	4030017460	S.CER C1005 JB 1H 102K-T	B	37.7/40.7
C36	4030017460	S.CER C1005 JB 1H 102K-T	B	51.5/41.2
C37	4030017730	S.CER C1005 JB 1H 471K-T	B	49.0/42.7
C38	4030017460	S.CER C1005 JB 1H 102K-T	B	39.2/35.9
C39	4030017640	S.CER C1005 CH 1H 150J-T	B	52.8/40.2
C40	4030017540	S.CER C1005 CH 1H R75B-T	B	54.1/39.2
C41	4030017410	S.CER C1005 CH 1H 240J-T	B	66.9/39.2
C42	4030017460	S.CER C1005 JB 1H 102K-T	B	54.0/37.8
C43	4030016930	S.CER C1005 JB 1A 104K-T	B	54.1/38.3
C44	4030017580	S.CER C1005 CH 1H 060C-T	B	59.9/40.5
C45	4030017640	S.CER C1005 CH 1H 150J-T	B	55.5/42.0
C48	4030017420	S.CER C1005 CH 1H 470J-T	B	72.2/40.6
C49	4030017380	S.CER C1005 CH 1H 050B-T	B	75.9/39.2
C50	4030017460	S.CER C1005 JB 1H 102K-T	B	73.1/40.6
C51	4030017460	S.CER C1005 JB 1H 102K-T	T	72.4/41.1

[MAIN-C UNIT] (For [350 MHz band] versions)

REF NO.	PARTS NO.	DESCRIPTION	M.	H/V LOCATION
C52	4030017620	S.CER C1005 CH 1H 100C-T	B	70.4/41.2
C53	4030016790	S.CER C1005 JB 1E 103K-T	B	71.3/42.8
C54	4030017730	S.CER C1005 JB 1H 471K-T	B	70.4/42.8
C57	4030017460	S.CER C1005 JB 1H 102K-T	B	74.6/36.7
C58	4030017460	S.CER C1005 JB 1H 102K-T	T	67.2/61.6
C59	4030017460	S.CER C1005 JB 1H 102K-T	T	66.9/22.7
C60	4030016790	S.CER C1005 JB 1E 103K-T	T	65.3/26.6
C61	4030017430	S.CER C1005 CH 1H 101J-T	T	61.6/23.1
C62	4030017420	S.CER C1005 CH 1H 470J-T	B	57.1/24.3
C63	4030017420	S.CER C1005 CH 1H 470J-T	T	60.3/14.3
C64	4030016790	S.CER C1005 JB 1E 103K-T	B	56.2/26.8
C65	4030018860	S.CER C1005 JB 0J 105K-T	T	58.2/19.6
C66	4030017460	S.CER C1005 JB 1H 102K-T	T	54.7/19.9
C67	4030017460	S.CER C1005 JB 1H 102K-T	B	58.4/21.3
C68	4030017680	S.CER C1005 CH 1H 820J-T	T	52.2/23.8
C69	4030017710	S.CER C1005 CH 1H 181J-T	T	54.0/23.8
C70	4030017710	S.CER C1005 CH 1H 181J-T	T	54.0/25.6
C71	4030016930	S.CER C1005 JB 1A 104K-T	T	57.4/29.0
C72	4030017730	S.CER C1005 JB 1H 471K-T	T	59.8/48.0
C74	4030017730	S.CER C1005 JB 1H 471K-T	B	11.2/50.5
C75	4030019560	S.CER GRM21BB31C106KE15L	T	61.6/25.3
C76	4030016790	S.CER C1005 JB 1E 103K-T	T	57.8/54.9
C77	4030017460	S.CER C1005 JB 1H 102K-T	T	56.8/50.7
C78	4030017730	S.CER C1005 JB 1H 471K-T	B	58.8/56.6
C79	4030016960	S.CER C1005 JB 1E 183K-T	T	62.4/55.0
C81	4030017460	S.CER C1005 JB 1H 102K-T	T	65.1/55.0
C82	4030011030	S.CER GRM31M4C2H1R5CY21L (GRM42-6 CK)	T	34.9/65.2
C84	4030017420	S.CER C1005 CH 1H 470J-T	T	55.0/61.6
C85	4030017460	S.CER C1005 JB 1H 102K-T	T	56.0/61.6
C86	4030017710	S.CER C1005 CH 1H 181J-T	T	81.3/63.8
C87	4030017460	S.CER C1005 JB 1H 102K-T	T	79.8/68.8
C88	4030017730	S.CER C1005 JB 1H 471K-T	T	64.6/52.1
C89	4030017600	S.CER C1005 CH 1H 080C-T	B	87.3/57.5
C90	4030017600	S.CER C1005 CH 1H 080C-T	B	88.2/57.5
C92	4030017570	S.CER C1005 CH 1H 040B-T	B	89.9/58.0
C93	4030017630	S.CER C1005 CH 1H 120J-T	B	86.9/51.4
C96	4030017460	S.CER C1005 JB 1H 102K-T	B	87.8/56.3
C97	4030017730	S.CER C1005 JB 1H 471K-T	B	87.8/55.4
C98	4030017730	S.CER C1005 CH 1H 050B-T	B	83.5/48.7
C99	4030017380	S.CER C1005 JB 1H 471K-T	B	81.4/48.3
C100	4030017600	S.CER C1005 CH 1H 080C-T	B	91.2/34.9
C102	4030017580	S.CER C1005 CH 1H 060C-T	B	97.1/33.8
C103	4030017360	S.CER C1005 CH 1H 030B-T	B	98.5/32.2
C104	4030017460	S.CER C1005 JB 1H 102K-T	B	100.8/29.9
C105	4030017730	S.CER C1005 JB 1H 471K-T	B	97.6/28.9
C106	4030017420	S.CER C1005 CH 1H 470J-T	B	91.7/48.9
C107	4030017460	S.CER C1005 JB 1H 102K-T	T	80.2/51.7
C108	4030016790	S.CER C1005 JB 1E 103K-T	B	81.3/49.2
C109	4030017460	S.CER C1005 JB 1H 102K-T	B	95.8/35.3
C110	4030017730	S.CER C1005 JB 1H 471K-T	B	98.6/35.3
C111	4030017730	S.CER C1005 JB 1H 471K-T	T	101.7/37.1
C112	4030016930	S.CER C1005 JB 1A 104K-T	T	100.8/37.1
C113	4030017520	S.CER C1005 CH 1H 0R3B-T	B	102.0/29.6
C114	4030017610	S.CER C1005 CH 1H 090C-T	B	98.3/26.1
C115	4030017400	S.CER C1005 CH 1H 220J-T	B	98.8/21.9
C116	4030017460	S.CER C1005 JB 1H 102K-T	B	107.5/30.0
C117	4030017730	S.CER C1005 JB 1H 471K-T	B	107.5/30.9
C118	4030017520	S.CER C1005 CH 1H 0R3B-T	B	102.8/32.0
C119	4030016790	S.CER C1005 JB 1E 103K-T	B	97.0/21.9
C120	4030017730	S.CER C1005 JB 1H 471K-T	B	97.9/21.9
C121	4030017590	S.CER C1005 CH 1H 070C-T	B	103.3/30.8
C122	4030017390	S.CER C1005 CH 1H 180J-T	B	107.5/31.8
C123	4030017670	S.CER C1005 CH 1H 390J-T	B	104.8/28.2
C124	4030017660	S.CER C1005 CH 1H 330J-T	B	105.0/20.8
C125	4030017420	S.CER C1005 CH 1H 470J-T	B	101.7/27.5
C126	4030018070	S.CER C1005 CH 1H 300J-T	B	95.6/23.7
C127	4030017660	S.CER C1005 CH 1H 330J-T	B	96.1/21.9
C128	4030017360	S.CER C1005 CH 1H 030B-T	B	99.2/27.3
C129	4030017530	S.CER C1005 CH 1H 0R5B-T	B	103.5/27.5
C131	4030017600	S.CER C1005 CH 1H 080C-T	B	106.4/27.2
C132	4030017460	S.CER C1005 JB 1H 102K-T	T	94.3/12.6
C133	4030017640	S.CER C1005 CH 1H 150J-T	B	105.4/22.8
C134	4030017390	S.CER C1005 CH 1H 180J-T	B	93.7/22.7
C135	4030016790	S.CER C1005 JB 1E 103K-T	T	78.3/21.0
C136	4030017370	S.CER C1005 CH 1H 3R5B-T	B	95.2/20.1
C139	4030016930	S.CER C1005 JB 1A 104K-T	B	107.5/33.6
C140	4030017430	S.CER C1005 CH 1H 101J-T	B	81.2/18.9
C141	4030017460	S.CER C1005 JB 1H 102K-T	T	75.7/21.5
C143	4030017460	S.CER C1005 JB 1H 102K-T	T	78.9/22.2
C144	4030017420	S.CER C1005 CH 1H 470J-T	T	92.5/16.1
C146				

[MAIN-C UNIT] (For [350 MHz band] versions)

REF NO.	PARTS NO.	DESCRIPTION	M.	H/V LOCATION
C299	4030017580	S.CER C1005 CH 1H 060C-T	T	83.9/29.4
C300	4030017560	S.CER C1005 CH 1H 2R5B-T	T	85.1/30.8
C301	4030017730	S.CER C1005 JB 1H 471K-T	B	92.8/31.3
C302	4030017420	S.CER C1005 CH 1H 470J-T	B	80.1/39.2
C303	4030017730	S.CER C1005 JB 1H 471K-T	B	80.1/36.3
C305	4030017500	S.CER C1005 CH 1H 560J-T	B	64.8/24.2
C306	4030017580	S.CER C1005 CH 1H 060C-T	B	64.3/25.4
C307	4030017500	S.CER C1005 CH 1H 560J-T	B	61.3/22.7
C308	4030017360	S.CER C1005 CH 1H 030B-T	B	60.1/23.2
C309	4030016790	S.CER C1005 JB 1E 103K-T	B	67.4/21.8
C312	4030016930	S.CER C1005 JB 1A 104K-T	B	67.4/20.9
C314	4030016790	S.CER C1005 JB 1E 103K-T	T	110.5/33.8
C323	4030017620	S.CER C1005 CH 1H 100C-T	B	72.3/26.2
C328	4030017340	S.CER C1005 CH 1H 010B-T	B	85.4/55.8
C332	4030017530	S.CER C1005 CH 1H 0R5B-T	B	84.9/50.0
C333	4030017420	S.CER C1005 CH 1H 470J-T	B	40.4/40.7
C334	4030017590	S.CER C1005 CH 1H 070C-T	B	94.9/68.3
C335	4030017630	S.CER C1005 CH 1H 120J-T	B	93.8/68.3
C336	4030017710	S.CER C1005 CH 1H 181J-T	B	62.0/68.7
C337	4030017460	S.CER C1005 JB 1H 102K-T	T	82.7/29.2
C340	4030017710	S.CER C1005 CH 1H 181J-T	B	107.7/28.7
C342	4550002980	S.TAN TEESVA 1C 225M8R	T	78.4/66.1
C343	4030017460	S.CER C1005 JB 1H 102K-T	B	51.5/39.2
C344	4030017460	S.CER C1005 JB 1H 102K-T	B	54.2/68.0
C345	4030017730	S.CER C1005 JB 1H 471K-T	B	54.2/67.1
C346	4030017420	S.CER C1005 CH 1H 470J-T	B	66.0/68.7
C347	4030017460	S.CER C1005 JB 1H 102K-T	T	52.2/22.9
C348	4030017460	S.CER C1005 JB 1H 102K-T	T	59.3/20.5
C350	4030017920	S.CER C1005 JB 1A 683K-T	T	95.9/14.4
C357	4030016930	S.CER C1005 JB 1A 104K-T	T	103.5/34.7
C358	4030017340	S.CER C1005 CH 1H 010B-T	B	91.2/35.8
C366	4030017460	S.CER C1005 JB 1H 102K-T	B	97.0/64.4
C367	4030017730	S.CER C1005 JB 1H 471K-T	B	97.0/65.8
C368	4030017420	S.CER C1005 CH 1H 470J-T	B	97.0/67.3
C372	4030017730	S.CER C1005 JB 1H 471K-T	T	60.3/67.7
C376	4030017730	S.CER C1005 JB 1H 471K-T	B	88.7/49.5
C377	4030017460	S.CER C1005 JB 1H 102K-T	T	57.8/61.6
C383	4030018860	S.CER C1005 JB 0J 105K-T	T	36.4/36.2
C384	4030016930	S.CER C1005 JB 1A 104K-T	T	59.3/29.0
C385	4030016930	S.CER C1005 JB 1A 104K-T	B	54.9/28.9
C388	4030017730	S.CER C1005 JB 1H 471K-T	B	68.2/36.7
C390	4030017460	S.CER C1005 JB 1H 102K-T	B	75.0/40.6
C391	4030017420	S.CER C1005 CH 1H 470J-T	B	75.9/40.6
C392	4030017540	S.CER C1005 CH 1H R75B-T	B	60.3/39.2
C393	4030017570	S.CER C1005 CH 1H 040B-T	B	66.3/40.5
C394	4030016930	S.CER C1005 JB 1A 104K-T	B	50.9/28.8
C395	4030016930	S.CER C1005 JB 1A 104K-T	B	45.1/29.0
C396	4030016930	S.CER C1005 JB 1A 104K-T	T	55.8/29.0
C397	4030016790	S.CER C1005 JB 1E 103K-T	B	50.4/12.7
C398	4030016790	S.CER C1005 JB 1E 103K-T	B	48.6/27.3
C399	4030016790	S.CER C1005 JB 1E 103K-T	B	48.3/28.5
C400	4030017710	S.CER C1005 CH 1H 181J-T	T	81.2/37.6
C401	4030017580	S.CER C1005 CH 1H 060C-T	B	78.6/40.6
C402	4030011070	S.CER GRM31M2C2H5R0CY21L (GRM42-6 CH)	B	38.0/68.7
C403	4030011070	S.CER GRM31M2C2H5R0CY21L (GRM42-6 CH)	B	34.9/65.2
C404	4030011110	S.CER GRM31M2C2H9R0DV01L (GRM42-6 CH)	B	15.5/60.7
C408	4030017730	S.CER C1005 JB 1H 471K-T	B	23.9/48.1
C409	4030017460	S.CER C1005 JB 1H 102K-T	B	39.3/51.1
C411	4030017460	S.CER C1005 JB 1H 102K-T	T	42.2/55.4
C413	4030018860	S.CER C1005 JB 0J 105K-T	B	91.5/25.3
C416	4030017420	S.CER C1005 CH 1H 470J-T	B	93.4/25.3
C418	4030018890	S.CER C1005 JB 0J 224K-T	T	102.8/17.3
C420	4030011110	S.CER GRM31M2C2H9R0DV01L (GRM42-6 CH)	B	21.7/60.7
C421	4030011080	S.CER GRM31M2C2H6R0DV01L (GRM42-6 CH)	B	28.2/60.7
C423	4030017570	S.CER C1005 CH 1H 040B-T	B	77.7/40.6
C429	4030017640	S.CER C1005 CH 1H 150J-T	B	61.9/42.0
C447	4030017730	S.CER C1005 JB 1H 471K-T	B	83.3/52.0
C448	4030017670	S.CER C1005 CH 1H 390J-T	B	87.8/49.5
C453	4030017420	S.CER C1005 CH 1H 470J-T	B	101.3/35.3
C454	4030017460	S.CER C1005 JB 1H 102K-T	B	100.4/35.3
C457	4030017420	S.CER C1005 CH 1H 470J-T	B	54.0/37.4
C458	4030017420	S.CER C1005 CH 1H 470J-T	T	63.8/50.8
C459	4030017420	S.CER C1005 CH 1H 470J-T	B	61.1/48.4
C460	4030017420	S.CER C1005 CH 1H 470J-T	T	84.9/49.8
C463	4030017720	S.CER C1005 JB 1H 331K-T	T	54.0/26.5
C466	4030017420	S.CER C1005 CH 1H 470J-T	T	62.7/49.8
C467	4030017420	S.CER C1005 CH 1H 470J-T	T	88.4/10.4
C471	4030017420	S.CER C1005 CH 1H 470J-T	B	103.7/19.2
C494	4030018860	S.CER C1005 JB 0J 105K-T	T	37.3/36.2
C624	4030017460	S.CER C1005 JB 1H 102K-T	B	81.2/26.7
C625	4030019990	S.CER C1005 JB 1C 104K-T	B	63.3/16.4
C626	4030017430	S.CER C1005 CH 1H 101J-T	B	59.9/20.5
C627	4030018910	S.CER C1608 JB 0J 475K-T	B	57.7/19.6
C628	4030017590	S.CER C1005 CH 1H 070C-T	T	63.3/36.2
C629	4030017530	S.CER C1005 CH 1H 0R5B-T	T	66.8/29.7
C630	4030016790	S.CER C1005 JB 1E 103K-T	T	68.6/28.8
C631	4030016790	S.CER C1005 JB 1E 103K-T	T	68.6/41.6
C632	4030016790	S.CER C1005 JB 1E 103K-T	T	76.5/41.6
C633	4030016930	S.CER C1005 JB 1A 104K-T	T	81.3/43.1
C634	4030016930	S.CER C1005 JB 1A 104K-T	T	80.0/41.2
C635	4030016790	S.CER C1005 JB 1E 103K-T	T	71.5/29.7
C637	4030017600	S.CER C1005 CH 1H 080C-T	T	72.3/36.2
C638	4030017460	S.CER C1005 JB 1H 102K-T	T	83.5/42.2
C639	4030016930	S.CER C1005 JB 1A 104K-T	T	46.8/25.7
C640	4030017040	S.CER C1005 JB 1A 333K-T	B	38.8/24.4
C641	4030018890	S.CER C1005 JB 0J 224K-T	B	76.3/27.1
C642	4030018890	S.CER C1005 JB 0J 224K-T	B	77.5/27.0
C643	4030017430	S.CER C1005 CH 1H 101J-T	B	77.5/27.9
C644	4030019560	S.CER GRM21BB31C106KE15L	B	81.7/20.4
C645	4030016930	S.CER C1005 JB 1A 104K-T	B	30.0/15.7

[MAIN-C UNIT] (For [350 MHz band] versions)

REF NO.	PARTS NO.	DESCRIPTION	M.	H/V LOCATION
C646	4030017460	S.CER C1005 JB 1H 102K-T	T	84.7/10.0
C647	4030016790	S.CER C1005 JB 1E 103K-T	B	59.1/27.7
C1003	4030017460	S.CER C1005 JB 1H 102K-T	T	133.3/63.5
C1005	4030018980	S.CER C1608 JB 1H 104K-T	B	100.1/11.8
C1007	4030017460	S.CER C1005 JB 1H 102K-T	T	100.1/12.1
C1008	4510009680	S.ELE EEEFK1E471P	B	110.2/52.6
C1010	4030017460	S.CER C1005 JB 1H 102K-T	B	106.5/59.0
C1011	4030016930	S.CER C1005 JB 1A 104K-T	B	93.9/12.1
C1012	4030017420	S.CER C1005 CH 1H 470J-T	B	117.5/16.6
C1014	4030017460	S.CER C1005 JB 1H 102K-T	T	116.6/27.5
C1015	4030017460	S.CER C1005 JB 1H 102K-T	T	114.9/8.0
C1017	4030017460	S.CER C1005 JB 1H 102K-T	B	122.5/64.9
C1018	4030017460	S.CER C1005 JB 1H 102K-T	T	133.3/45.0
C1019	4510009250	S.ELE EEEFK1C471P	B	130.5/34.8
C1022	4030017420	S.CER C1005 CH 1H 470J-T	B	105.5/59.0
C1023	4030017460	S.CER C1005 JB 1H 102K-T	B	113.4/58.8
C1024	4030017440	S.CER C1005 CH 1H 221J-T	B	113.4/59.7
C1025	4030017510	S.CER C1005 CH 1H 680J-T	B	113.4/60.6
C1026	4030019120	S.CER GRM188B31E105KA75D	T	115.8/49.5
C1028	4030017460	S.CER C1005 JB 1H 102K-T	B	117.4/6.1
C1029	4030017460	S.CER C1005 JB 1H 102K-T	T	114.9/12.6
C1031	4030017460	S.CER C1005 JB 1H 102K-T	T	115.0/16.9
C1032	4030016930	S.CER C1005 JB 1A 104K-T	B	123.6/16.1
C1033	4510009680	S.ELE EEEFK1E471P	B	120.0/29.6
C1034	4030018860	S.CER C1005 JB 0J 105K-T	B	131.6/16.6
C1035	4030016790	S.CER C1005 JB 1E 103K-T	B	131.6/18.7
C1036	4030018980	S.CER C1608 JB 1H 104K-T	T	128.4/46.9
C1037	4030019560	S.CER GRM21BB31C106KE15L	B	129.4/43.4
C1038	4030011600	S.CER C1608 JB 1E 104K-T	T	110.5/48.7
C1039	4510009680	S.ELE EEEFK1E471P	B	117.0/41.7
C1040	4030019560	S.CER GRM21BB31C106KE15L	B	116.7/22.2
C1042	4030016930	S.CER C1005 JB 1A 104K-T	B	118.1/22.4
C1043	4030016930	S.CER C1005 JB 1A 104K-T	T	114.9/16.0
C1045	4030017460	S.CER C1005 JB 1H 102K-T	T	114.9/14.2
C1046	4030018860	S.CER C1005 JB 0J 105K-T	T	114.9/15.1
C1048	4030018900	S.CER C1005 JB 0J 474K-T	B	126.7/18.6
C1050	4030018860	S.CER C1005 JB 0J 105K-T	B	125.2/16.6
C1051	4030017460	S.CER C1005 JB 1H 102K-T	B	122.1/48.2
C1052	4030016930	S.CER C1005 JB 1A 104K-T	T	127.8/40.1
C1053	4030019560	S.CER GRM21BB31C106KE15L	T	127.8/44.5
C1056	4030018860	S.CER C1005 JB 0J 105K-T	T	111.2/11.7
C1057	4030016930	S.CER C1005 JB 1A 104K-T	B	118.7/17.1
C1058	4030019560	S.CER GRM21BB31C106KE15L	T	105.5/44.4
C1059	4030017460	S.CER C1005 JB 1H 102K-T	T	107.7/46.3
C1060	4030017460	S.CER C1005 JB 1H 102K-T	B	126.2/39.8
C1061	4030017460	S.CER C1005 JB 1H 102K-T	T	107.7/37.4
C1062	4030017460	S.CER C1005 JB 1H 102K-T	B	120.7/22.9
C1063	4030019560	S.CER GRM21BB31C106KE15L	B	126.9/22.2
C1064	4030019560	S.CER GRM21BB31C106KE15L	B	121.6/36.0
C1065	4030017460	S.CER C1005 JB 1H 102K-T	B	120.2/35.6
C1066	4030018860	S.CER C1005 JB 0J 105K-T	B	125.6/38.1
C1070	4030017440	S.CER C1005 CH 1H 221J-T	B	120.4/16.2
C1071	4030016930	S.CER C1005 JB 1A 104K-T	B	120.4/10.8
C1074	4030017460	S.CER C1005 JB 1H 102K-T	B	73.9/10.4
C1075	4030017460	S.CER C1005 JB 1H 102K-T	B	70.7/14.4
C1076	4030017460	S.CER C1005 JB 1H 102K-T	B	69.7/14.4
C1077	4030017460	S.CER C1005 JB 1H 102K-T	B	68.8/14.4
C1080	4030016790	S.CER C1005 JB 1E 103K-T	B	51.1/15.3
C1081	4030016930	S.CER C1005 JB 1A 104K-T	B	117.2/15.2
C1082	4030019560	S.CER C1005 JB 1A 104K-T	B	114.8/16.3
C1083	4030017460	S.CER C1005 JB 1H 102K-T	T	37.6/19.3
C1084	4030017710	S.CER C1005 CH 1H 181J-T	B	41.9/20.8
C1092	4030016930	S.CER C1005 JB 1A 104K-T	B	75.8/14.4
C1095	4030016930	S.CER C1005 JB 1A 104K-T	T	38.5/19.3
C1096	4030018860	S.CER C1005 JB 0J 105K-T	T	51.7/18.5
C1097	4030018240	S.CER C1005 JB 1H 562K-T	B	50.8/17.8
C1098	4030018860	S.CER C1005 JB 0J 105K-T	T	54.5/16.3
C1099	4030018860	S.CER C1005 JB 0J 105K-T	B	45.2/20.8
C1100	4030017460	S.CER C1005 JB 1H 102K-T	B	75.8/9.1
C1101	4030016930	S.CER C1005 JB 1A 104K-T	T	78.2/8.0
C1102	4030017420	S.CER C1005 CH 1H 470J-T	B	71.6/6.6
C1106	4030016930	S.CER C1005 JB 1A 104K-T	T	36.3/20.6
C1107	4030017440	S.CER C1005 CH 1H		

[MAIN-C UNIT] (For [350 MHz band] versions)

REF NO.	PARTS NO.	DESCRIPTION	M.	H/V LOCATION
C2012	4030016930	S.CER C1005 JB 1A 104K-T	B	26.4/5.8
C2013	4550007730	S.TAN TEESVJ OJ 106M8R	B	25.0/6.2
C2014	4030016930	S.CER C1005 JB 1A 104K-T	T	31.7/6.6
C2015	4030016930	S.CER C1005 JB 1A 104K-T	B	10.1/6.4
C2016	4550007720	S.TAN TEESVP OG 476M8R	T	26.7/7.1
C2017	4550007730	S.TAN TEESVJ OJ 106M8R	B	17.2/9.2
C2018	4030016930	S.CER C1005 JB 1A 104K-T	B	9.2/6.4
C2019	4030016790	S.CER C1005 JB 1E 103K-T	B	14.8/19.3
C2021	4030018910	S.CER C1608 JB 0J 475K-T	B	16.0/21.6
C2022	4030018910	S.CER C1608 JB 0J 475K-T	B	13.5/14.5
C2023	4030016790	S.CER C1005 JB 1E 103K-T	B	23.1/14.3
C2024	4030018860	S.CER C1005 JB 0J 105K-T	B	21.2/14.1
C2025	4030017420	S.CER C1005 CH 1H 470J-T	B	20.8/11.1
C2026	4030017460	S.CER C1005 JB 1H 102K-T	B	20.8/10.2
C2027	4030018910	S.CER C1608 JB 0J 475K-T	B	10.9/10.0
C2028	4030018860	S.CER C1005 JB 0J 105K-T	T	11.5/10.2
C2031	4030018860	S.CER C1005 JB 0J 105K-T	T	20.9/11.3
C2032	4030016930	S.CER C1005 JB 1A 104K-T	T	13.1/11.7
C2033	4030018860	S.CER C1005 JB 0J 105K-T	B	15.1/17.7
C2034	4030016930	S.CER C1005 JB 1A 104K-T	T	11.9/7.9
C2035	4030018910	S.CER C1608 JB 0J 475K-T	T	10.2/8.2
C2036	4030018860	S.CER C1005 JB 0J 105K-T	B	21.1/20.9
C2038	4030016790	S.CER C1005 JB 1E 103K-T	B	16.4/25.3
C2039	4030017430	S.CER C1005 CH 1H 101J-T	B	19.7/7.5
C2040	4030016790	S.CER C1005 JB 1E 103K-T	T	26.4/18.1
C2041	4030018910	S.CER C1608 JB 0J 475K-T	T	11.1/14.5
C2042	4030016930	S.CER C1005 JB 1A 104K-T	T	10.1/14.8
C2044	4030016790	S.CER C1005 JB 1E 103K-T	T	26.4/19.9
C2045	4030016930	S.CER C1005 JB 1A 104K-T	B	26.6/23.4
C2046	4030016930	S.CER C1005 JB 1A 104K-T	B	26.6/24.3
C2047	4030016930	S.CER C1005 JB 1A 104K-T	B	26.6/20.7
C2048	4030016930	S.CER C1005 JB 1A 104K-T	B	26.6/22.5
C2049	4030017420	S.CER C1005 CH 1H 470J-T	B	25.7/9.5
C2050	4030017620	S.CER C1005 CH 1H 100C-T	B	26.7/15.8
C2051	4030016930	S.CER C1005 JB 1A 104K-T	B	13.6/29.4
C2052	4030016930	S.CER C1005 JB 1A 104K-T	B	25.5/15.3
C2053	4030017460	S.CER C1005 JB 1H 102K-T	B	27.4/10.4
C2054	4030016930	S.CER C1005 JB 1A 104K-T	T	25.5/12.4
C2055	4030017400	S.CER C1005 CH 1H 220J-T	B	11.0/20.3
C2056	4030017380	S.CER C1005 CH 1H 050B-T	T	27.2/10.7
C2057	4030016930	S.CER C1005 JB 1A 104K-T	B	24.1/10.4
C2058	4030016790	S.CER C1005 JB 1E 103K-T	B	28.8/13.7
C2059	4030017620	S.CER C1005 CH 1H 100C-T	B	18.9/6.2
C2060	4030016780	S.CER C1005 JB 1E 153K-T	B	12.2/11.7
C2062	4030018860	S.CER C1005 JB 0J 105K-T	T	9.4/20.1
C2063	4030017420	S.CER C1005 CH 1H 470J-T	T	2.1/14.7
C2064	4030017420	S.CER C1005 CH 1H 470J-T	T	2.5/13.5
C2065	4030017420	S.CER C1005 CH 1H 470J-T	T	3.8/13.0
C2066	4030017420	S.CER C1005 CH 1H 470J-T	T	6.5/16.5
C2067	4030017420	S.CER C1005 CH 1H 470J-T	T	7.5/24.0
C2068	4030017620	S.CER C1005 CH 1H 100C-T	T	19.5/5.3
C2069	4030017420	S.CER C1005 CH 1H 470J-T	T	27.5/17.2
C2070	4030016930	S.CER C1005 JB 1A 104K-T	B	21.0/12.5
C2071	4030016930	S.CER C1005 JB 1A 104K-T	B	21.7/19.7
C2072	4030016930	S.CER C1005 JB 1A 104K-T	B	17.2/23.8
C2073	4030016930	S.CER C1005 JB 1A 104K-T	B	20.2/16.0
C2074	4030017420	S.CER C1005 CH 1H 470J-T	T	13.1/5.3
C2075	4030017430	S.CER C1005 CH 1H 101J-T	B	18.3/15.9
C2076	4030016930	S.CER C1005 JB 1A 104K-T	T	7.7/27.1
C2077	4030019610	S.CER GRM155B31A105KE15D	B	41.2/6.1
C2078	4030017460	S.CER C1005 JB 1H 102K-T	B	39.8/8.9
C2079	4030017460	S.CER C1005 JB 1H 102K-T	B	38.2/8.9
C2080	4030016790	S.CER C1005 JB 1E 103K-T	B	36.7/5.4
C2081	4550007730	S.TAN TEESVJ OJ 106M8R	B	36.5/7.2
J1001	6510014961	S.CON B2B-ZR-SM4-TF(LF)(SN)	T	130.5/27.3
J1002	6450000140	CON HSJ0807-01-010		
J1003	6510022891	S.CON B13B-ZR-SM4-TF(LF)(SN)	T	120.0/17.2
J1004	6510027960	S.CON 04-6294-040-000-800	T	67.5/10.6
S1001	2260003180	S.SWI MINISMDC050F-2 CN	T	114.1/33.8
W1	7030012290	JUM RDS2T0R0		
W2	8900011863	CAB OPC-1195C <TJM>		
EP1	6910018460	S.BEA MMZ1005Y102C-T	B	107.5/32.7
EP4	6910010280	BEA HF70BB9.5X10.4X4.9		
EP5	6910010280	BEA HF70BB9.5X10.4X4.9		
EP7	6910018460	S.BEA MMZ1005Y102C-T	B	74.2/19.4
EP8	6910018460	S.BEA MMZ1005Y102C-T	B	80.8/16.7
EP13	6910018460	S.BEA MMZ1005Y102C-T	B	100.1/25.3
EP2001	6910016330	S.BEA MMZ1005S 601CT-S	B	22.8/5.3
EP2003	6910016330	S.BEA MMZ1005S 601CT-S	T	9.1/7.0
EP2004	6910016330	S.BEA MMZ1005S 601CT-S	T	32.7/9.0
EP2005	6910016330	S.BEA MMZ1005S 601CT-S	B	24.6/23.8
EP2007	6910016330	S.BEA MMZ1005S 601CT-S	T	10.8/6.2

M.=Mounted side (T: Mounted on the Top side, B: Mounted on the Bottom side)
S.=Surface mount

• MAIN-A/MAIN-B/MAIN-C UNIT (2/3)

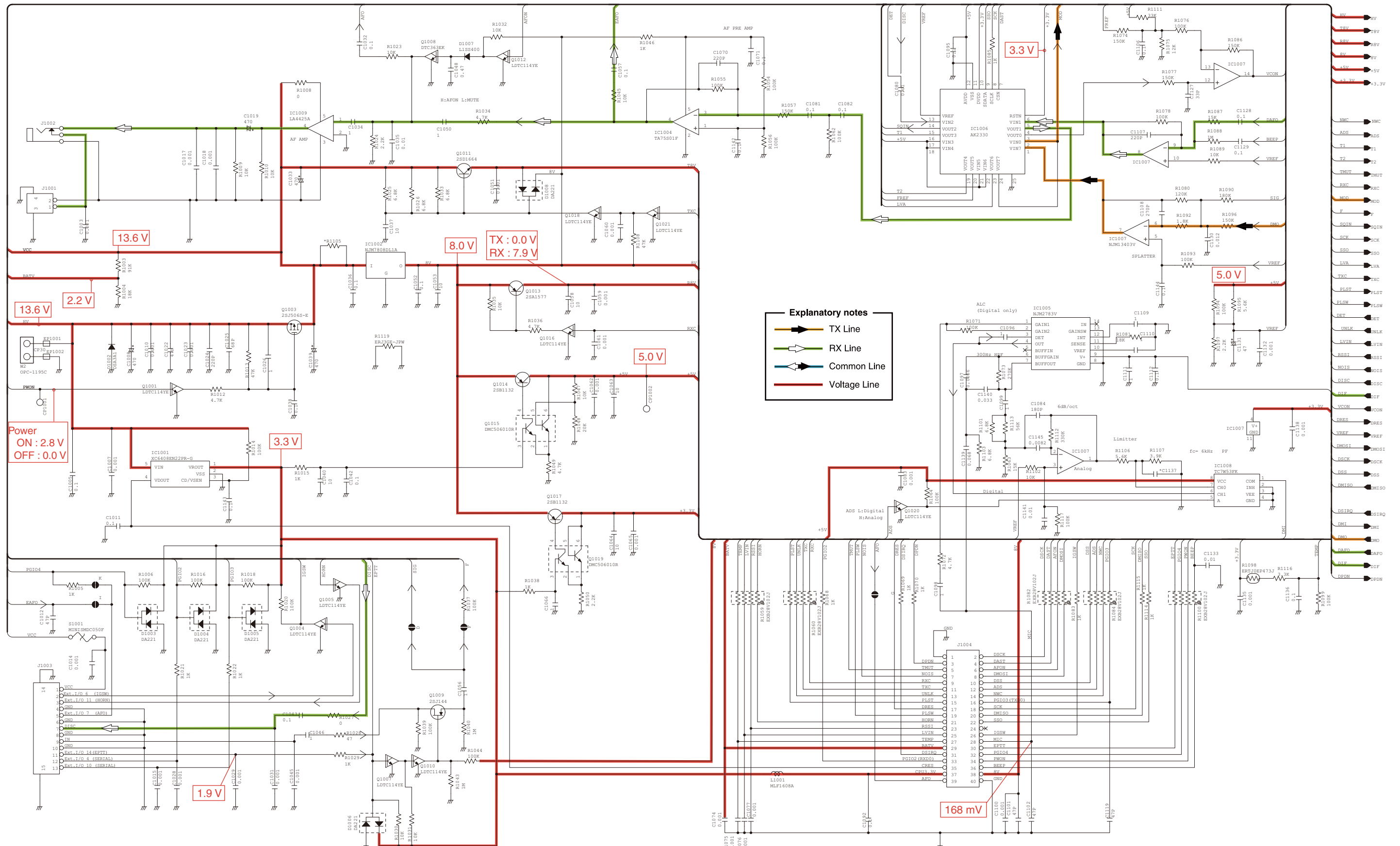

*: Refer to the PARTS LIST for the value and name of component.

Nov. 2011



SERVICE MANUAL ADDENDUM

IC-F6120D IC-F6122D IC-F6123D IC-F6128D

CONTENTS

PARTS LIST	1
BOARD LAYOUTS	17
VOLTAGE DIAGRAM	19

PARTS LIST

[MAIN-A UNIT] (For [Low band] versions)

REF NO.	PARTS NO.	DESCRIPTION	M.	H/V LOCATION
IC2	1110002751	S.IC TA75S01F(TE85RF)	T	60/54.9
IC3	1150002380	IC RA30H4047M1-101 [EUR-01]		
	1150002380	IC RA30H4047M1-101 [EXP-01]		
	1150002400	IC RA60H4047M1-121 [USA-01]		
	1150002400	IC RA60H4047M1-121 [EXP-03]		
	1150002400	IC RA60H4047M1-121 [CHN-01]		
IC4	1110007320	S.IC NJM2591V-TE1-#ZZZB	T	57.8/24.7
IC5	1110006230	S.IC NJM2711F-TE1-#ZZZB	B	38.8/27.0
IC6	1110002751	S.IC TA75S01F(TE85RF)	B	43.0/21.2
IC7	1130011741	S.IC TC7W66FK(TE85LF)	B	28.3/24.7
IC8	1130015271	S.IC AK1541P4-L	B	78.2/23.7
IC1001	1180003660	S.REG XC6408EN22PR-G	B	96.9/10.8
IC1002	1180003500	S.REG NJM7808DL1A-TE1-#FZZB	T	123.3/45.7
IC1004	1110002751	S.IC TA75S01F(TE85RF)	B	119.7/13.0
IC1005	1110007630	S.IC NJM2783V-TE1-#ZZZH	T	47.4/18.9
IC1006	1110007290	S.IC AK2330P-L	B	53.7/11.5
IC1007	1110005320	S.IC NJM13403V-TE1-#ZZZB	B	37.4/17.0
IC1008	1130009981	S.IC TC7W53FK(TE85LF)	T	40.3/19.7
IC1009	1110003091	S.IC LA4425A-E		
IC2001	1180003680	S.REG TPS62204DBVR	B	32.4/6.5
IC2002	1190002900	S.IC ADS7886SDCKR	B	14.4/9.3
IC2006	1110007770	S.IC PCM3008T2K	T	16.3/8.3
IC2007	1140013290	S.IC TMS320VC5509AZHH	T	18.0/18.4
IC2008	1130015620	S.IC EN25Q40-100GIP <MSK>	B	12.5/25.3
IC2009	1110006230	S.IC NJM2711F-TE1-#ZZZB	B	26.7/12.7
IC2010	1180003600	S.REG NJM2871BF05-TE1-#ZZZB	B	39.0/6.8
Q1	1590004090	S.TRA LDTC114YET1G <SLVJ>	B	47.2/27.1
Q2	1580000731	S.FET 3SK293(TE85LF)	B	41.5/38.7
Q3	1560000541	S.FET 2SK880-Y(T5RICOMF)	T	77.2/24.5
Q4	1530002851	S.TRA 2SC4116-BL(TE85RF)	B	67.9/25.4
Q5	1530002851	S.TRA 2SC4116-BL(TE85RF)	T	44.9/25.3
Q6	1590004090	S.TRA LDTC114YET1G <SLVJ>	T	62.2/52.2
Q7	1560000841	S.FET 2SK1829(TE85RF)	T	33.7/39.7
Q8	1530002680	S.TRA 2SC3357-T1	B	90.4/52.8
Q9	1560001360	S.FET 2SK3019 TL	T	52.2/26.3
Q10	1530003311	S.TRA 2SC5107-O(TE85RF)	B	92.8/33.1
Q11	1530003311	S.TRA 2SC5107-O(TE85RF)	B	100.5/31.7
Q12	1530004110	S.TRA MT3S37T(TE85LF)	B	97.6/30.4
Q13	1590004090	S.TRA LDTC114YET1G <SLVJ>	B	57.6/27.2
Q14	1530003311	S.TRA 2SC5107-O(TE85RF)	T	64.8/24.9
Q15	1590004500	S.TRA DMC561040R	T	101.0/34.4
Q17	1530002851	S.TRA 2SC4116-BL(TE85RF)	T	107.7/33.4
Q18	1590004090	S.TRA LDTC114YET1G <SLVJ>	T	81.5/40.8
Q19	1580000731	S.FET 3SK293(TE85LF)	B	71.4/38.4
Q20	1530002851	S.TRA 2SC4116-BL(TE85RF) [USA-01]	T	60.0/49.8
	1530002851	S.TRA 2SC4116-BL(TE85RF) [EXP-03]		
	1530002851	S.TRA 2SC4116-BL(TE85RF) [CHN-01]		
Q21	1590004090	S.TRA LDTC114YET1G <SLVJ>	T	49.5/24.8
Q23	1530002921	S.TRA 2SC4226-T1 Y25 (R25)	B	105.2/30.9
Q24	1530002921	S.TRA 2SC4226-T1 Y25 (R25)	B	98.3/24.2
Q25	1530003260	S.TRA 2SC5006-T1	B	84.9/51.5
Q1001	1590004090	S.TRA LDTC114YET1G <SLVJ>	T	110.6/44.1
Q1003	1550000190	S.FET 2SJ506STR-E	T	113.3/45.4
Q1004	1590004090	S.TRA LDTC114YET1G <SLVJ>	T	114.0/26.7
Q1005	1590004090	S.TRA LDTC114YET1G <SLVJ>	T	114.0/24.7
Q1007	1590004090	S.TRA LDTC114YET1G <SLVJ>	B	116.3/8.1
Q1008	1590000990	S.TRA DTC363EK T146	B	128.9/17.8
Q1009	1590001451	S.FET 2SJ144-GR (TE85RF)	B	113.8/11.1
Q1010	1590004090	S.TRA LDTC114YET1G <SLVJ>	B	116.1/10.9
Q1011	1540000550	S.TRA 2SD1664 T100Q	B	125.1/47.6
Q1012	1590004090	S.TRA LDTC114YET1G <SLVJ>	B	130.9/20.7
Q1013	1510000920	S.TRA 2SA1577 T106 Q	T	107.7/44.3
Q1014	1520000460	S.TRA 2SB1132 T100 R	B	123.5/21.1
Q1015	1590004590	S.TRA DMC506010R	B	118.9/20.4
Q1016	1590004090	S.TRA LDTC114YET1G <SLVJ>	T	107.8/39.2
Q1017	1520000460	S.TRA 2SB1132 T100 R	T	120.1/35.2
Q1018	1590004090	S.TRA LDTC114YET1G <SLVJ>	B	126.4/43.3
Q1019	1590004590	S.TRA DMC506010R	B	123.8/35.8
Q1020	1590004090	S.TRA LDTC114YET1G <SLVJ>	T	42.6/22.5
Q1021	1590004090	S.TRA LDTC114YET1G <SLVJ>	B	126.4/41.3
Q2001	1590004040	S.TRA LDTA123YET1G <SLVJ>	B	26.9/26.6
D2	1750001910	S.DIO HVD144AKRF-E	B	52.6/28.5
D3	1750001910	S.DIO HVD144AKRF-E	B	52.6/27.3
D4	1750000711	S.VAR HVC350BTRF-E	B	36.0/40.2
D5	1750002060	S.DIO RNY752E-21	T	26.5/53.3
D7	1750001910	S.DIO HVD144AKRF-E	B	25.3/45.3
D8	1750001910	S.DIO HVD144AKRF-E	B	43.4/27.3
D9	1750001910	S.DIO HVD144AKRF-E	B	43.4/28.6
D10	1750000711	S.VAR HVC350BTRF-E	B	55.5/39.9
D11	1750001820	S.DIO LRB706F-40T1G <SLVJ>	B	8.2/49.9
D12	1750001820	S.DIO LRB706F-40T1G <SLVJ>	B	28.8/49.9
D13	1750001910	S.DIO HVD144AKRF-E	T	66.3/28.1
D14	1750001910	S.DIO HVD144AKRF-E	T	69.5/28.1
D15	1790001261	S.DIO MA2S077G0L	B	82.2/39.2
D16	1750000711	S.VAR HVC350BTRF-E	B	106.7/20.3
D17	1750001910	S.DIO HVD144AKRF-E	T	70.6/41.6
D18	1750001910	S.DIO HVD144AKRF-E	T	74.5/41.6
D19	1750000711	S.VAR HVC350BTRF-E	B	61.9/39.9
D20	1750000711	S.VAR HVC350BTRF-E	B	28.0/40.2
D21	1750000711	S.VAR HVC350BTRF-E	B	36.0/41.6
D22	1750000711	S.VAR HVC350BTRF-E	B	28.0/41.6
D23	1750000711	S.VAR HVC350BTRF-E	B	52.8/42.6
D24	1750002060	S.DIO RNY752E-21	T	35.1/56.7
D25	1750000581	S.DIO 1SV307(TPH3F)	B	83.5/42.1

[MAIN-A UNIT] (For [Low band] versions)

REF NO.	PARTS NO.	DESCRIPTION	M.	H/V LOCATION
D26	1750001650	S.VAR 1SV309(TPH3F)	B	101.8/25.9
D29	1750001820	S.DIO LRB706F-40T1G <SLVJ>	B	19.2/49.9
D33	1750000711	S.VAR HVC350BTRF-E	B	97.8/20.5
D62	1750000711	S.VAR HVC350BTRF-E	B	91.7/22.8
D64	1750002270	S.VAR HVD396CKRF-E	B	106.7/21.5
D66	1750000370	S.DIO DA221 TL	T	33.7/37.1
D67	1750002170	S.DIO DB2S31400L [EUR-01]	T	31.8/39.7
	1750002170	S.DIO DB2S31400L [EXP-01]		
	1790001241	S.DIO MA2S7280GL [USA-01]		
	1790001241	S.DIO MA2S7280GL [EXP-03]		
	1750002170	S.DIO DB2S31400L [CHN-01]		
D1002	1790000700	DIO DSA3A1		
D1003	1750000370	S.DIO DA221 TL	B	114.0/8.2
D1004	1750000370	S.DIO DA221 TL	B	114.1/6.1
D1005	1750000370	S.DIO DA221 TL	T	113.2/7.4
D1006	1750000370	S.DIO DA221 TL	T	113.0/10.3
D1007	1750001810	S.DIO L1SS400T1G <SLVJ>	B	129.0/20.7
D1008	1750000370	S.DIO DA221 TL	B	124.0/43.3
D2002	1750002170	S.DIO DB2S31400L [EUR-01]	T	24.9/18.0
	1750002170	S.DIO DB2S31400L [EXP-01]		
	1790001241	S.DIO MA2S7280GL [USA-01]		
	1790001241	S.DIO MA2S7280GL [EXP-03]		
	1750002170	S.DIO DB2S31400L [CHN-01]		
D2003	1750002170	S.DIO DB2S31400L [EUR-01]	B	10.7/30.5
	1750002170	S.DIO DB2S31400L [EXP-01]		
	1750002170	S.DIO DB2S31400L [CHN-01]		
	1790001241	S.DIO MA2S7280GL [USA-01]		
D2004	1750002170	S.DIO DB2S31400L [EXP-01]	B	22.1/21.4
	1750002170	S.DIO DB2S31400L [EXP-01]		
	1790001241	S.DIO MA2S7280GL [USA-01]		
	1790001241	S.DIO MA2S7280GL [EXP-03]		
D2005	1750002170	S.DIO DB2S31400L [CHN-01]	B	17.5/26.3
	1750002170	S.DIO DB2S31400L [EUR-01]		
	1750002170	S.DIO DB2S31400L [EXP-01]		
	1790001241	S.DIO MA2S7280GL [USA-01]		
D2006	1790001241	S.DIO MA2S7280GL [EXP-03]		
	1750002170	S.DIO DB2S31400L [CHN-01]	T	12.0/25.3
	1750002170	S.DIO DB2S31400L [EUR-01]		
	1790001241	S.DIO MA2S7280GL [USA-01]		
D2008	1790001241	S.DIO MA2S7280GL [EXP-03]		
	1750002170	S.DIO DB2S31400L [CHN-01]		
	1750002170	S.DIO DB2S31400L [EUR-01]		
	1790001241	S.DIO MA2S7280GL [USA-01]		
	1750002170	S.DIO DB2S31400L [EXP-03]		
	1750002020	S.DIO DA2S10100L	T	100.3/6.5
F11	2020002570	CER LTM450HW <JJE>		
F12	2020002410	CER LTM450FW <JJE>		
F13	2020002610	S.CER LTUCG450G <JJE>	T	36.3/28.0
F14	2030000870	S.MON MFT46.3P3 46.350 MHz (FL-442)	T	66.9/34.9
F15	2010002760	S.XTA MFT46.3J 46.350 MHz (FL-448)	T	75.8/34.9
F16	2040001440	S.LC NFE31PT152Z1E9L (NFM60R20T152)	B	97.7/62.2
F17	2040001440	S.LC NFE31PT152Z1E9L (NFM60R20T152)	B	97.7/58.9
	2040001440	S.LC NFE31PT152Z1E9L (NFM60R20T152)		
F18	2040001440	S.LC NFE31PT152Z1E9L (NFM60R20T152) [USA-01]	B	97.7/55.4
	2040001440	S.LC NFE31PT152Z1E9L (NFM60R20T152) [EXP-03]		
	2040001440	S.LC NFE31PT152Z1E9L (NFM60R20T152) [CHN-01]		
X1	6070000300	S.DIS JTBM450CX24 <JJE>	B	51.4/22.5
X2	6050013000	S.XTA CR-892 TTS14VSB-A8 15.3 MHz	B	71.5/21.0
X2001	6050013170	S.XTA CR-914 TTS18VSE-A11 12.288 MHz	B	27.0/18.2
L1	6200010150	S.COI AS080340-15N	B	8.4/62.7
L2	6200010150	S.COI AS080340-15N	B	12.9/55.5
L3	6200010150	S.COI AS080340-15N	B	20.7/55.5
L4	6200013100	S.COI 0.45-1.5-STL 18.3N <COMO>	T	31.1/50.5
L5	6200010420	S.COI FHW1210HC 1R0JGT <JJE>	T	38.5/58.4
L6	6200010150	S.COI AS080340-15N	B	27.3/55.5
L7	6200012870	S.COI 0.30-1.4-5TR 23.5N <COMO>	B	28.8/37.8
L8	6200012870	S.COI 0.30-1.4-5TR 23.5N <COMO>	B	35.2/37.8
L9	6200012170	S.COI MLG1608S R18J-T	B	65.8/24.7
L10	6200011690	S.COI C2520C-12NG-A	B	49.0/39.8
L11	6200011690	S.COI C2520C-12NG-A	B	57.8/40.5
L12	6200012170	S.COI MLG1608S R18J-T	B	62.3/22.4
L13	6200007901	S.COI ELJRF 22NJFB	T	85.1/29.9
L16	6200010150	S.COI AS080340-15N	B	38.2/65.2
L17	6200005661	S.COI ELJRE 10NGFA	B	85.4/57.9
L18	6200005701	S.COI ELJRE 22NGFA	B	88.1/58.9
L19	6200005711	S.COI ELJRE 27NGFA	B	89.9/56.0
L20	6200010090	S.COI ELJND R82JF	B	68.9/40.9
L21	620000571			

[MAIN-A UNIT] (For [Low band] versions)

REF NO.	PARTS NO.	DESCRIPTION	M.	H/V LOCATION
L54	6200007370	S.COI ELJFC R82K-F	T	100.0/30.4
L55	6200004741	S.COI NLV25T-1R2J	B	103.7/33.8
L56	6200011690	S.COI C2520C-12NG-A	B	64.2/40.5
L57	6200011860	S.COI LQW18ANR47G00D	B	92.6/24.0
L58	6200011860	S.COI LQW18ANR47G00D	B	105.9/19.1
L1001	6200004660	S.COI MLF1608A 1R8K-T	T	79.8/13.3
L2001	6200014160	S.COI VLFC4028T-100M1R0-2	T	35.9/7.6
L2002	6200007830	S.COI ELJFC 4R7K-F	B	31.2/11.2
R1	7030000620	S.RES MCR10EZJH 100 K (104)	B	12.3/65.5
R4	7030003560	S.RES ERJ3GEYJ 103 V (10K)	B	16.4/50.6
R5	7030008010	S.RES ERJ2GEJ 123 X (12K) [EUR-01]	B	11.2/49.6
	7030008010	S.RES ERJ2GEJ 123 X (12K) [EXP-01]		
	7030005220	S.RES ERJ2GEJ 223 X (22K) [USA-01]		
	7030005220	S.RES ERJ2GEJ 223 X (22K) [EXP-03]		
R6	7030005220	S.RES ERJ2GEJ 223 X (22K) [CHN-01]	B	19.8/48.1
	7030008010	S.RES ERJ2GEJ 123 X (12K) [EUR-01]		
	7030008010	S.RES ERJ2GEJ 123 X (12K) [EXP-01]		
	7030005220	S.RES ERJ2GEJ 223 X (22K) [USA-01]		
	7030005220	S.RES ERJ2GEJ 223 X (22K) [EXP-03]		
	7030005220	S.RES ERJ2GEJ 223 X (22K) [CHN-01]		
R7	7030003560	S.RES ERJ3GEYJ 103 V (10K)	B	8.2/53.2
R8	7030006070	S.RES ERJ12YJ101U (100)	B	45.7/51.9
R9	7030003560	S.RES ERJ3GEYJ 103 V (10K)	B	25.6/50.6
R10	7030008010	S.RES ERJ2GEJ 123 X (12K) [EUR-01]	B	22.2/48.1
	7030008010	S.RES ERJ2GEJ 123 X (12K) [EXP-01]		
	7030005220	S.RES ERJ2GEJ 223 X (22K) [USA-01]		
	7030005220	S.RES ERJ2GEJ 223 X (22K) [EXP-03]		
	7030005220	S.RES ERJ2GEJ 223 X (22K) [CHN-01]		
R11	7030005050	S.RES ERJ2GEJ 103 X (10K)	B	31.5/40.5
R12	7030004980	S.RES ERJ2GEJ 101 X (100)	B	39.2/39.5
R13	7030005050	S.RES ERJ2GEJ 103 X (10K)	B	32.5/40.5
R14	7030005050	S.RES ERJ2GEJ 103 X (10K)	B	32.5/38.8
R15	7030005700	S.RES ERJ2GEJ 274 X (270K)	B	39.2/38.6
R16	7030004990	S.RES ERJ2GEJ 221 X (220) [EUR-01]	B	39.5/40.7
	7030004980	S.RES ERJ2GEJ 101 X (100) [EXP-01]		
	7030004980	S.RES ERJ2GEJ 101 X (100) [USA-01]		
	7030004980	S.RES ERJ2GEJ 101 X (100) [EXP-03]		
	7030004980	S.RES ERJ2GEJ 101 X (100) [CHN-01]		
R17	7030005530	S.RES ERJ2GEJ 100 X (10)	B	51.5/40.2
R18	7030005050	S.RES ERJ2GEJ 103 X (10K)	B	60.8/40.5
R19	7030005090	S.RES ERJ2GEJ 104 X (100K)	B	39.2/36.8
R20	7030005120	S.RES ERJ2GEJ 102 X (1K)	B	52.8/38.6
R21	7030005050	S.RES ERJ2GEJ 103 X (10K)	B	54.1/40.2
R22	7030005050	S.RES ERJ2GEJ 103 X (10K)	B	56.2/37.4
R23	7030005050	S.RES ERJ2GEJ 103 X (10K)	B	54.1/41.2
R29	7030009200	S.RES ERJ2GEJ 390 X (39) [EUR-01]	B	74.0/40.6
	7030005570	S.RES ERJ2GEJ 820 X (82) [EXP-01]		
	7030005570	S.RES ERJ2GEJ 820 X (82) [USA-01]		
	7030005570	S.RES ERJ2GEJ 820 X (82) [EXP-03]		
	7030005570	S.RES ERJ2GEJ 820 X (82) [CHN-01]		
R30	7030007300	S.RES ERJ2GEJ 332 X (3.3K)	B	71.3/41.2
R31	7030004980	S.RES ERJ2GEJ 101 X (100)	B	66.9/37.4
R33	7030005600	S.RES ERJ2GEJ 273 X (27K)	T	71.9/42.7
R34	7030005110	S.RES ERJ2GEJ 224 X (220K)	T	64.9/23.1
R35	7030005530	S.RES ERJ2GEJ 100 X (10)	T	64.9/22.2
R36	7030005030	S.RES ERJ2GEJ 152 X (1.5K)	B	56.2/21.7
R37	7030008400	S.RES ERJ2GEJ 182 X (1.8K)	B	56.6/25.5
R38	7030005090	S.RES ERJ2GEJ 104 X (100K)	T	61.7/17.8
R39	7030004970	S.RES ERJ2GEJ 470 X (47)	B	58.4/22.2
R40	7030005030	S.RES ERJ2GEJ 152 X (1.5K)	B	58.4/23.2
R41	7030010040	S.RES ERJ2GEJ-JPW	T	60.8/17.8
R42	7030005070	S.RES ERJ2GEJ 683 X (68K)	T	51.0/24.3
R43	7030005000	S.RES ERJ2GEJ 471 X (470)	T	55.6/19.1
R44	7030005310	S.RES ERJ2GEJ 124 X (120K)	T	54.0/24.7
R45	7030005310	S.RES ERJ2GEJ 124 X (120K)	T	52.2/24.7
R46	7030008410	S.RES ERJ2GEJ 392 X (3.9K)	T	54.0/22.9
R48	7030008300	S.RES ERJ2GEJ 184 X (180K) [USA-01]	T	56.8/53.2
	7030008300	S.RES ERJ2GEJ 184 X (180K) [EXP-03]		
	7030008300	S.RES ERJ2GEJ 184 X (180K) [CHN-01]		
R49	7520000241	S.POS PRF18BC471QB5RB [USA-01]	T	47.3/53.2
	7520000241	S.POS PRF18BC471QB5RB [EXP-03]		
	7520000241	S.POS PRF18BC471QB5RB [CHN-01]		
R50	7030005050	S.RES ERJ2GEJ 103 X (10K)	B	80.1/37.9
R51	7030008290	S.RES ERJ2GEJ 183 X (18K) [EUR-01]	T	61.8/49.8
	7030008290	S.RES ERJ2GEJ 183 X (18K) [EXP-01]		
	7030005080	S.RES ERJ2GEJ 823 X (82K) [USA-01]		
	7030005080	S.RES ERJ2GEJ 823 X (82K) [EXP-03]		
	7030005080	S.RES ERJ2GEJ 823 X (82K) [CHN-01]		
R52	7030005070	S.RES ERJ2GEJ 683 X (68K)	T	58.7/52.1
R53	7030004990	S.RES ERJ2GEJ 221 X (220)	T	57.8/53.2
R54	7030005050	S.RES ERJ2GEJ 103 X (10K) [EUR-01]	B	58.8/55.7
	7030005050	S.RES ERJ2GEJ 103 X (10K) [EXP-01]		
	7030005220	S.RES ERJ2GEJ 223 X (22K) [USA-01]		
	7030005220	S.RES ERJ2GEJ 223 X (22K) [EXP-03]		
	7030005220	S.RES ERJ2GEJ 223 X (22K) [CHN-01]		
R56	7030005110	S.RES ERJ2GEJ 224 X (220K) [EUR-01]	T	63.3/55.0
	7030005110	S.RES ERJ2GEJ 224 X (220K) [EXP-01]		
	7030005100	S.RES ERJ2GEJ 154 X (150K) [USA-01]		
	7030005100	S.RES ERJ2GEJ 154 X (150K) [EXP-03]		
	7030005100	S.RES ERJ2GEJ 154 X (150K) [CHN-01]		
R57	7030005050	S.RES ERJ2GEJ 103 X (10K)	B	58.8/54.8
R58	7030004980	S.RES ERJ2GEJ 101 X (100)	T	64.2/55.0
R59	7030008290	S.RES ERJ2GEJ 183 X (18K) [EUR-01]	T	59.7/52.1
	7030008290	S.RES ERJ2GEJ 183 X (18K) [EXP-01]		
	7030007350	S.RES ERJ2GEJ 393 X (39K) [USA-01]		
	7030007350	S.RES ERJ2GEJ 393 X (39K) [EXP-03]		
	7030007350	S.RES ERJ2GEJ 393 X (39K) [CHN-01]		
R61	7030004970	S.RES ERJ2GEJ 470 X (47)	B	90.5/49.5
R62	7030008290	S.RES ERJ2GEJ 183 X (18K)	B	89.6/49.5
R66	7030005090	S.RES ERJ2GEJ 104 X (100K)	B	84.9/49.1
R67	7030004980	S.RES ERJ2GEJ 101 X (100)	B	83.0/47.3
R68	7030005050	S.RES ERJ2GEJ 103 X (10K)	B	82.6/48.7
R69	7030005040	S.RES ERJ2GEJ 472 X (4.7K)	B	84.0/38.0

[MAIN-A UNIT] (For [Low band] versions)

REF NO.	PARTS NO.	DESCRIPTION	M.	H/V LOCATION
R70	7030004990	S.RES ERJ2GEJ 221 X (220)	B	92.8/35.8
R71	7030007260	S.RES ERJ2GEJ 330 X (33)	B	95.3/33.8
R72	7030004980	S.RES ERJ2GEJ 101 X (100)	B	86.5/49.1
R73	7030004980	S.RES ERJ2GEJ 471 X (470) [EUR-01]	B	99.5/35.3
	7030005000	S.RES ERJ2GEJ 471 X (470) [EXP-01]		
	7030004980	S.RES ERJ2GEJ 101 X (100) [USA-01]		
	7030004980	S.RES ERJ2GEJ 101 X (100) [EXP-03]		
	7030004980	S.RES ERJ2GEJ 101 X (100) [CHN-01]		
R74	7030005080	S.RES ERJ2GEJ 823 X (82K)	B	101.3/33.7
R75	7030005720	S.RES ERJ2GEJ 563 X (56K)	B	97.6/32.2
R76	7030009270	S.RES ERJ2GEJ 821 X (820)	B	96.7/32.2
R77	7030005120	S.RES ERJ2GEJ 102 X (1K)	T	105.6/36.0
R78	7030008370	S.RES ERJ2GEJ 561 X (560)	T	102.5/32.5
R79	7030006020	S.RES RR0510P-682-D (6.8K)	B	96.5/23.7
R80	7030009270	S.RES ERJ2GEJ 821 X (820)	T	100.0/32.5
R83	7030006020	S.RES RR0510P-682-D (6.8K)	B	106.4/29.1
R84	7030006020	S.RES RR0510P-682-D (6.8K)	B	106.4/29.2
R85	7030006020	S.RES RR0510P-682-D (6.8K)	B	95.6/25.3
R86	7030005110	S.RES ERJ2GEJ 224 X (220K)	B	102.6/24.4
R87	7030005530	S.RES ERJ2GEJ 100 X (10)	B	102.6/27.5
R89	7030005050	S.RES ERJ2GEJ 103 X (10K)	T	79.0/25.0
R90	7030005170	S.RES ERJ2GEJ 474 X (470K)	T	95.9/15.3
R92	7030005100	S.RES ERJ2GEJ 154 X (150K)	T	94.3/14.4
R93	7030005600	S.RES ERJ2GEJ 273 X (27K)	B	81.3/25.8
R95	7030005710	S.RES ERJ2GEJ 121 X (120)	B	83.8/24.5
R96	7030007290	S.RES ERJ2GEJ 222 X (2.2K)	B	83.8/23.5
R97	7030010040	S.RES ERJ2GEJ-JPW	B	82.2/24.5
R98	7030007290	S.RES ERJ2GEJ 222 X (2.2K)	T	109.5/33.8
R100	7030005240	S.RES ERJ2GEJ 473 X (47K)	T	76.1/20.3
R101	7030004980	S.RES ERJ2GEJ 101 X (100)	T	77.9/22.2
R123	7030005530	S.RES ERJ2GEJ 100 X (10)	T	68.2/40.4
R125	7030008370	S.RES ERJ2GEJ 561 X (560)	T	65.6/29.2
R171	7030004980	S.RES ERJ2GEJ 101 X (100)	T	45.5/28.6
R172	7030008300	S.RES ERJ2GEJ 184 X (180K)	T	44.2/27.1
R173	7030005120	S.RES ERJ2GEJ 102 X (1K)	T	42.9/26.4
R174	7030005290	S.RES ERJ2GEJ 682 X (6.8K)	T	42.0/28.8
R175	7030009290	S.RES ERJ2GEJ 562 X (5.6K)	T	41.6/27.6
R176	7030005030	S.RES ERJ2GEJ 152 X (1.5K)	T	42.0/26.4
R178	7030004970	S.RES ERJ2GEJ 470 X (47)	B	39.8/24.4
R211	7030004970	S.RES ERJ2GEJ 470 X (47)	T	82.7/23.8
R212	7030010040	S.RES ERJ2GEJ-JPW	T	82.6/60.4
R234	7030005720	S.RES ERJ2GEJ 563 X (56K) [EUR-01]	B	92.8/34.9
	7030005070	S.RES ERJ2GEJ 683 X (68K) [EXP-01]		
	7030005070	S.RES ERJ2GEJ 683 X (68K) [USA-01]		
	7030005070	S.RES ERJ2GEJ 683 X (68K) [EXP-03]		
	7030005070	S.RES ERJ2GEJ 683 X (68K) [CHN-01]		
R235	7030004980	S.RES ERJ2GEJ 101 X (100)	B	81.0/37.9
R236	7030007570	S.RES ERJ2GEJ 122 X (1.2K)	B	67.4/22.7
R237	7030007060	S.RES ERJ2GEJ 684X (680K)	B	67.4/23.6
R289	7030005240	S.RES ERJ2GEJ 473 X (47K)	T	95.9/12.6
R290	7030005010	S.RES ERJ2GEJ 681 X (680)	T	63.2/23.1
R291	7030005090	S.RES ERJ2GEJ 104 X (100K)	T	94.3/13.5
R293	7030006610	S.RES ERJ2GEJ 394 X (390K)	T	88.4/12.0
R295	7030006610	S.RES ERJ2GEJ 394 X (390K)	T	101.0/17.3
R299	7030008300	S.RES ERJ2GEJ 184 X (180K)	B	74.6/38.5
R300	7030005720	S.RES ERJ2GEJ 563 X (56K)	B	76.8/40.6
R301	7030005100	S.RES ERJ2GEJ 154 X (150K)	B	67.5/40.5
R302	7030005720	S.RES ERJ2GEJ 563 X (56K)	B	66.9/38.3
R308	7030009140	S.RES ERJ2GEJ 272 X (2.7K)	T	56.9/54.9
R311	7030010040	S.RES ERJ2GEJ-JPW	B	94.9/32.2
R317	7030005120	S.RES ERJ2GEJ 102 X (1K)	T	105.6/37.4
R319	7030007340	S.RES ERJ2GEJ 153 X (15K)	T	37.3/37.9
R320	7030005170	S.RES ERJ2GEJ 474 X (470K)	T	35.5/36.2
R328	7030010040	S.RES ERJ2GEJ-JPW	B	104.8/29.1
R334	7030005000	S.RES ERJ2GEJ 471 X (470)	T	87.6/61.3
R337	7030005530	S.RES ERJ2GEJ 100 X (10)	T	87.1/62.7
R338	7030005000	S.RES ERJ2GEJ 471 X (470)	T	87.6/64.1
R339	7030010040	S.RES ERJ2GEJ-JPW	B	96.5/25.3
R340	7030005050	S.RES ERJ2GEJ 103 X (10K)	B	72.4/25.3
R350	7030005600	S.RES ERJ2GEJ 273 X (27K)	B	52.9/26.2
R351	7030005600	S.RES ERJ2GEJ 273 X (27K)	B	43.2/26.3
R352	7030007300	S.RES ERJ2GEJ 332 X (3.3K)	B	50.9/26.8
R353	7030005210	S.RES ERJ2GEJ 822 X (8.2K)	B	45.4/27.3
R354	7030005210	S.RES ERJ2GEJ 822 X (8.2K)	B	46.1/29.0
R394	7030010040	S.RES ERJ2GEJ-JPW	B	100.1/27.3
R395	7030010040	S.RES ERJ2GEJ-JPW	B	26.7/46.8
R478	7030007340	S.RES ERJ2GEJ 153 X (15K)	B	35.5/26.3
R479	7030005600	S.RES ERJ2GEJ 273 X (27K)	T	66.8/27.4
R483	7030007300	S.RES ERJ2GEJ 332 X (3.3K)	T	71.5/28.8
R484	7030007300	S.RES ERJ2GEJ 332 X (3.3K)	T	76.5/42.5
R485	7030010040	S.RES ERJ2GEJ-JPW	T	77.0/40.4
R486	7030005000	S.RES ERJ2GEJ 471 X (470)	T	73.2/29.7
R488	7030007300	S.RES ERJ2GEJ 332 X (3.3K)	T	68.6/42.7
R489	7030007300	S.RES ERJ2GEJ 332 X (3.3K)	T	68.

[MAIN-A UNIT] (For [Low band] versions)

REF NO.	PARTS NO.	DESCRIPTION	M.	H/V LOCATION
R1005	7030005120	S.RES ERJ2GEJ 102 X (1K)	T	112.3/16.5
R1006	7030005090	S.RES ERJ2GEJ 104 X (100K)	B	112.4/8.1
R1008	7030010040	S.RES ERJ2GEJ-JPW	T	124.9/24.8
R1009	7030005050	S.RES ERJ2GEJ 103 X (10K)	T	133.3/49.2
R1010	7030005050	S.RES ERJ2GEJ 103 X (10K)	T	128.6/23.5
R1012	7030005040	S.RES ERJ2GEJ 472 X (4.7K)	T	110.6/46.0
R1013	7030005240	S.RES ERJ2GEJ 473 X (47K)	T	114.7/24.0
R1014	7030005090	S.RES ERJ2GEJ 104 X (100K)	T	98.3/12.1
R1015	7030005120	S.RES ERJ2GEJ 102 X (1K)	B	115.3/22.8
R1016	7030005090	S.RES ERJ2GEJ 104 X (100K)	B	115.6/6.1
R1018	7030005090	S.RES ERJ2GEJ 104 X (100K)	T	111.7/7.0
R1020	7030005090	S.RES ERJ2GEJ 104 X (100K)	B	114.7/24.9
R1021	7030005120	S.RES ERJ2GEJ 102 X (1K)	B	116.5/6.1
R1022	7030005120	S.RES ERJ2GEJ 102 X (1K)	T	114.9/7.1
R1023	7030005050	S.RES ERJ2GEJ 103 X (10K)	B	125.2/15.7
R1024	7030007290	S.RES ERJ2GEJ 222 X (2.2K)	B	131.6/17.6
R1025	7030000480	S.RES MCR10EZHH 6.8K (682)	B	129.4/47.0
R1026	7030000480	S.RES MCR10EZHH 6.8K (682)	B	129.4/48.8
R1027	7030010040	S.RES ERJ2GEJ-JPW	T	113.7/16.5
R1028	7030004970	S.RES ERJ2GEJ 470 X (47K)	B	114.9/13.4
R1029	7030005120	S.RES ERJ2GEJ 102 X (1K)	T	115.3/10.5
R1030	7030005050	S.RES ERJ2GEJ 103 X (10K)	T	114.4/10.5
R1031	7030005050	S.RES ERJ2GEJ 103 X (10K)	B	117.8/7.7
R1032	7030005050	S.RES ERJ2GEJ 103 X (10K)	B	127.1/19.9
R1033	7030000480	S.RES MCR10EZHH 6.8K (682)	B	129.4/45.2
R1034	7030005040	S.RES ERJ2GEJ 472 X (4.7K)	B	123.6/17.5
R1035	7030005050	S.RES ERJ2GEJ 103 X (10K)	T	107.8/42.5
R1036	7030005040	S.RES ERJ2GEJ 472 X (4.7K)	T	107.8/41.2
R1037	7030005090	S.RES ERJ2GEJ 104 X (100K)	T	95.9/13.5
R1038	7030005120	S.RES ERJ2GEJ 102 X (1K)	B	125.6/36.3
R1039	7030005090	S.RES ERJ2GEJ 104 X (100K)	B	113.7/12.9
R1040	7030005160	S.RES ERJ2GEJ 105 X (1M)	T	111.2/12.9
R1043	7030005160	S.RES ERJ2GEJ 105 X (1M)	B	112.0/11.0
R1044	7030005090	S.RES ERJ2GEJ 104 X (100K)	B	117.9/9.9
R1045	7030005050	S.RES ERJ2GEJ 103 X (10K)	B	120.4/17.1
R1046	7030005800	S.RES RR0510P-102-D (1K)	B	119.7/9.0
R1047	7030005050	S.RES ERJ2GEJ 103 X (10K)	B	119.4/18.6
R1048	7030009710	S.RES ERJ2GEJ 203 X (20K)	B	119.0/22.4
R1049	7030005040	S.RES ERJ2GEJ 472 X (4.7K)	B	116.7/19.7
R1050	7030007290	S.RES ERJ2GEJ 222 X (2.2K)	B	123.0/38.1
R1054	7030008270	S.RES RR0510P-104-D (100K)	B	119.7/9.9
R1055	7030005090	S.RES ERJ2GEJ 104 X (100K)	B	120.4/15.2
R1056	7030008270	S.RES RR0510P-104-D (100K)	B	118.8/10.8
R1057	7030005100	S.RES ERJ2GEJ 154 X (150K)	B	118.8/15.2
R1059	7410001130	S.ARR EXB28V102JX	T	69.7/14.8
R1060	7410001130	S.ARR EXB28V102JX	T	63.4/14.8
R1062	7030008270	S.RES RR0510P-104-D (100K)	B	116.0/14.8
R1063	7030007340	S.RES ERJ2GEJ 153 X (15K)	B	42.8/22.4
R1064	7030005090	S.RES ERJ2GEJ 104 X (100K)	T	40.5/23.1
R1068	7030005120	S.RES ERJ2GEJ 102 X (1K)	T	74.3/14.1
R1069	7030005120	S.RES ERJ2GEJ 102 X (1K)	T	72.6/14.1
R1070	7030005120	S.RES ERJ2GEJ 102 X (1K)	T	57.3/15.1
R1071	7030005090	S.RES ERJ2GEJ 104 X (100K)	T	51.7/16.7
R1072	7030005040	S.RES ERJ2GEJ 472 X (4.7K)	T	52.9/16.3
R1073	7030005700	S.RES ERJ2GEJ 274 X (270K)	B	50.8/18.7
R1074	7030005100	S.RES ERJ2GEJ 154 X (150K)	T	32.7/20.6
R1075	7030008010	S.RES ERJ2GEJ 123 X (12K)	T	36.3/21.5
R1076	7030005090	S.RES ERJ2GEJ 104 X (100K)	B	35.0/20.5
R1077	7030005170	S.RES ERJ2GEJ 474 X (470K)	B	36.6/20.2
R1078	7030005090	S.RES ERJ2GEJ 104 X (100K)	B	32.2/15.2
R1080	7030005310	S.RES ERJ2GEJ 124 X (120K)	B	40.1/13.5
R1081	7030008290	S.RES ERJ2GEJ 183 X (18K)	T	42.5/19.5
R1082	7410001130	S.ARR EXB28V102JX	T	56.9/6.7
R1083	7030005120	S.RES ERJ2GEJ 102 X (1K)	B	69.1/8.8
R1084	7410001130	S.ARR EXB28V102JX	T	61.7/6.1
R1085	7030005120	S.RES ERJ2GEJ 102 X (1K)	B	49.5/9.9
R1086	7030005100	S.RES ERJ2GEJ 154 X (150K)	B	32.2/18.5
R1087	7030007340	S.RES ERJ2GEJ 153 X (15K)	B	41.3/15.2
R1088	7030005160	S.RES ERJ2GEJ 105 X (1M)	B	31.3/16.9
R1089	7030005050	S.RES ERJ2GEJ 103 X (10K)	B	44.2/16.9
R1090	7030008300	S.RES ERJ2GEJ 184 X (180K)	B	36.5/13.4
R1092	7030008400	S.RES ERJ2GEJ 182 X (1.8K)	B	38.3/13.5
R1093	7030005090	S.RES ERJ2GEJ 104 X (100K)	B	42.9/15.5
R1094	7030005090	S.RES ERJ2GEJ 104 X (100K)	T	55.7/12.8
R1095	7030009290	S.RES ERJ2GEJ 562 X (5.6K)	T	55.7/13.7
R1096	7030005100	S.RES ERJ2GEJ 154 X (150K)	B	35.6/13.4
R1097	7030007290	S.RES ERJ2GEJ 222 X (2.2K)	T	55.2/11.6
R1098	7510001730	S.THE ERTJJOEP 474J	T	74.9/15.5
R1099	7030008270	S.RES RR0510P-104-D (100K)	T	72.5/15.5
R1100	7410001130	S.ARR EXB28V102JX	T	75.3/6.0
R1101	7030005290	S.RES ERJ2GEJ 682 X (6.8K)	B	44.0/20.4
R1102	7030005040	S.RES ERJ2GEJ 472 X (4.7K)	B	42.4/16.4
R1103	7030005290	S.RES ERJ2GEJ 682 X (6.8K)	B	52.9/18.3
R1105	7030003860	S.RES ERJ3GE JPW V	T	127.8/48.9
R1106	7030009290	S.RES ERJ2GEJ 562 X (5.6K)	B	41.0/20.8
R1107	7030008410	S.RES ERJ2GEJ 392 X (3.9K)	B	39.2/20.8
R1108	7030005240	S.RES ERJ2GEJ 473 X (47K)	B	124.9/41.7
R1111	7030005060	S.RES ERJ2GEJ 333 X (33K)	T	36.3/19.7
R1112	7030005230	S.RES ERJ2GEJ 334 X (330K)	B	41.5/19.6
R1113	7030005720	S.RES ERJ2GEJ 563 X (56K)	B	44.0/21.3
R1114	7030005120	S.RES ERJ2GEJ 102 X (1K)	T	65.8/6.4
R1115	7030005120	S.RES ERJ2GEJ 102 X (1K)	T	65.8/5.4
R1116	7030007300	S.RES ERJ2GEJ 332 X (3.3K)	T	73.7/15.0
R1117	7030005090	S.RES ERJ2GEJ 104 X (100K)	B	42.4/18.2
R1119	7030003860	S.RES ERJ3GE JPW V [USA-01]	T	99.5/68.6
	7030003860	S.RES ERJ3GE JPW V [EXP-03]		
	7030003860	S.RES ERJ3GE JPW V [CHN-01]		
R2003	7030007250	S.RES ERJ2GEJ 220 X (22)	B	16.7/6.8
R2004	7030005210	S.RES ERJ2GEJ 822 X (8.2K)	B	12.6/8.8
R2005	7030005210	S.RES ERJ2GEJ 822 X (8.2K)	B	15.8/6.8
R2009	7030007290	S.RES ERJ2GEJ 222 X (2.2K)	B	10.5/11.7
R2010	7030004980	S.RES ERJ2GEJ 101 X (100)	T	11.5/11.7
R2011	7030004980	S.RES ERJ2GEJ 101 X (100)	T	23.0/10.4
R2012	7030004980	S.RES ERJ2GEJ 101 X (100)	T	22.5/11.3
R2013	7030005240	S.RES ERJ2GEJ 473 X (47K)	B	19.8/12.0

[MAIN-A UNIT] (For [Low band] versions)

REF NO.	PARTS NO.	DESCRIPTION	M.	H/V LOCATION
R2015	7030005240	S.RES ERJ2GEJ 473 X (47K)	T	18.4/11.6
R2016	7030010040	S.RES ERJ2GEJ-JPW	B	24.0/5.8
R2019	7030010040	S.RES ERJ2GEJ-JPW	B	9.9/17.9
R2020	7030010040	S.RES ERJ2GEJ-JPW	B	14.4/11.1
R2021	7030004980	S.RES ERJ2GEJ 101 X (100)	B	23.6/12.1
R2022	7030004980	S.RES ERJ2GEJ 101 X (100)	B	27.9/24.7
R2024	7030005240	S.RES ERJ2GEJ 473 X (47K)	B	26.6/21.6
R2026	7030004970	S.RES ERJ2GEJ 470 X (47K)	B	27.9/22.9
R2028	7030005240	S.RES ERJ2GEJ 473 X (47K)	B	12.1/19.3
R2030	7030005240	S.RES ERJ2GEJ 473 X (47K)	B	11.0/21.2
R2031	7030005240	S.RES ERJ2GEJ 473 X (47K)	B	10.7/29.4
R2032	7030005240	S.RES ERJ2GEJ 473 X (47K)	B	24.9/17.4
R2034	7030005240	S.RES ERJ2GEJ 473 X (47K)	B	28.8/10.5
R2035	7030005240	S.RES ERJ2GEJ 473 X (47K)	B	26.7/14.9
R2036	7030004980	S.RES ERJ2GEJ 101 X (100)	T	26.8/11.9
R2037	7030007290	S.RES ERJ2GEJ 222 X (2.2K)	T	28.1/10.7
R2038	7030004970	S.RES ERJ2GEJ 470 X (47K)	B	28.8/12.1
R2039	7030005240	S.RES ERJ2GEJ 473 X (47K)	B	24.1/9.5
R2040	7030005240	S.RES ERJ2GEJ 473 X (47K)	B	24.5/12.1
R2043	7410001140	S.ARR EXB28V104JX	T	15.6/26.7
R2044	7410001140	S.ARR EXB28V104JX	T	20.8/26.6
R2045	7410001140	S.ARR EXB28V104JX	T	27.0/22.3
R2046	7410001140	S.ARR EXB28V104JX	T	19.3/26.7
R2047	7410001140	S.ARR EXB28V104JX	B	10.9/14.5
R2048	7030005090	S.RES ERJ2GEJ 104 X (100K)	T	25.7/14.6
R2049	7030005090	S.RES ERJ2GEJ 104 X (100K)	B	21.8/15.6
R2050	7410001140	S.ARR EXB28V104JX	B	22.6/18.2
R2051	7410001140	S.ARR EXB28V104JX	T	9.9/11.6
R2052	7030005090	S.RES ERJ2GEJ 104 X (100K)	T	16.8/11.7
R2053	7030005090	S.RES ERJ2GEJ 104 X (100K)	B	16.0/14.5
R2056	7030010040	S.RES ERJ2GEJ-JPW	T	10.6/20.0
R2057	7030005090	S.RES ERJ2GEJ 104 X (100K)	T	10.4/22.9
R2058	7410001140	S.ARR EXB28V104JX	B	17.0/18.6
R2059	7030005090	S.RES ERJ2GEJ 104 X (100K)	T	10.4/23.8
R2060	7030005090	S.RES ERJ2GEJ 104 X (100K)	T	25.7/15.6
R2061	7030005090	S.RES ERJ2GEJ 104 X (100K)	B	14.7/12.6
R2062	7030005090	S.RES ERJ2GEJ 104 X (100K)	B	17.7/14.4
R2063	7030005090	S.RES ERJ2GEJ 104 X (100K)	B	22.1/23.4
R2064	7030005090	S.RES ERJ2GEJ 104 X (100K)	B	19.7/17.7
R2065	7030005030	S.RES ERJ2GEJ 152 X (1.5K)	B	13.8/6.8
R2066	7410001170	S.ARR EXB28V470JX	T	21.3/6.7
R2067	7030010040	S.RES ERJ2GEJ-JPW	T	11.4/5.3
R2068	7030010040	S.RES ERJ2GEJ-JPW	T	20.9/10.4
R2071	7030010040	S.RES ERJ2GEJ-JPW	T	24.9/5.7
R2072	7030005050	S.RES ERJ2GEJ 103 X (10K)	B	12.2/10.1
R2074	7030010040	S.RES ERJ2GEJ-JPW	T	8.7/10.0
R2084	7030010040	S.RES ERJ2GEJ-JPW	T	30.7/10.5
R2085	7030010040	S.RES ERJ2GEJ-JPW	B	19.5/9.6
C1	4030011070	S.CER GRM31M2C2H5R0CY21L (GRM42-6 CH)	B	8.4/66.6
C2	4030011070	S.CER GRM31M2C2H5R0CY21L (GRM42-6 CH)	B	7.4/58.6
C3	4030009500	S.CER C1608 CH 1H 0R5B-T	B	25.6/51.9
C4	4030009500	S.CER C1608 CH 1H 0R5B-T	B	16.4/51.9
C5	4030009500	S.CER C1608 CH 1H 0R5B-T	B	8.2/54.5
C6	4030011090	S.CER GRM31M2C2H7R0DV01L (GRM42-6 CH)	B	7.4/56.3
C7	4030011070	S.CER GRM31M2C2H5R0CY21L (GRM42-6 CH)	B	13.1/60.7
C8	4030011070	S.CER GRM31M2C2H5R0CY21L (GRM42-6 CH)	B	19.5/60.7
C9	4030011080	S.CER GRM31M2C2H6R0DV01L (GRM42-6 CH)	T	30.6/53.1
C10	4030017730	S.CER C1005 JB 1H 471K-T	B	18.1/48.1
C11	4030017730	S.CER C1005 JB 1H 471K-T	B	10.0/49.2
C12	4030017730	S.CER C1005 JB 1H 471K-T	T	39.4/54.4
C13	4030017420	S.CER C1005 CH 1H 470J-T	B	49.5/51.4
C14	4030019420	S.CER GRM31A7U2J102JW31D	B	34.9/55.5
C15	4030017570	S.CER C1005 CH 1H 050B-T [EUR-01]	T	23.7/50.4
	4030017380	S.CER C1005 CH 1H 050B-T [EXP-01]		
	4030017380	S.CER C1005 CH 1H 050B-T [USA-01]		
	4030017380	S.CER C1005 CH 1H 050B-T [EXP-03]		
	4030017380	S.CER C1005 CH 1H 050B-T [CHN-01]		
C20	4030017400	S.CER C1005 CH 1H 220J-T	B	30.6/40.5
C21	4030017590	S.CER C1005 CH 1H 070C-T	B	26.7/38.1
C22	4030017360	S.CER C1005 CH 1H 030B-T [EUR-01]	B	32.0/37.5
	4030017370	S.CER C1005 CH 1H 3R5B-T [EXP-01]		
	4030017370	S.CER C1005 CH 1H 3R5B-T [USA-01]		
	4030017370	S.CER C1005 CH 1H 3R5B-T [EXP-03]		
	4030017370	S.CER C1005 CH 1H 3R5B-T [CHN-01]		
C25	4030017420</			

[MAIN-A UNIT] (For [Low band] versions)

REF NO.	PARTS NO.	DESCRIPTION	M.	H/V LOCATION
C51	4030017460	S.CER C1005 JB 1H 102K-T	T	72.4/41.1
C52	4030017620	S.CER C1005 CH 1H 100C-T	B	70.4/41.2
C53	4030016790	S.CER C1005 JB 1E 103K-T	B	71.3/42.8
C54	4030017730	S.CER C1005 JB 1H 471K-T	B	70.4/42.8
C57	4030017460	S.CER C1005 JB 1H 102K-T	B	74.6/36.7
C58	4030017460	S.CER C1005 JB 1H 102K-T	T	67.2/26.1
C59	4030017460	S.CER C1005 JB 1H 102K-T	T	66.9/22.7
C60	4030016790	S.CER C1005 JB 1E 103K-T	T	65.3/26.6
C61	4030017430	S.CER C1005 CH 1H 101J-T	T	61.6/23.1
C62	4030017420	S.CER C1005 CH 1H 470J-T	B	57.1/24.3
C63	4030017420	S.CER C1005 CH 1H 470J-T	T	60.3/14.3
C64	4030016790	S.CER C1005 JB 1E 103K-T	B	56.2/26.8
C65	4030018860	S.CER C1005 JB 0J 105K-T	T	58.2/19.6
C66	4030017460	S.CER C1005 JB 1H 102K-T	T	54.7/19.9
C67	4030017460	S.CER C1005 JB 1H 102K-T	B	58.4/21.3
C68	4030017680	S.CER C1005 CH 1H 820J-T	T	52.2/23.8
C69	4030017710	S.CER C1005 CH 1H 181J-T	T	54.0/23.8
C70	4030017710	S.CER C1005 CH 1H 181J-T	T	54.0/25.6
C71	4030016930	S.CER C1005 JB 1A 104K-T	T	57.4/29.0
C72	4030017730	S.CER C1005 JB 1H 471K-T [USA-01]	T	59.8/48.0
	4030017730	S.CER C1005 JB 1H 471K-T [EXP-03]		
	4030017730	S.CER C1005 JB 1H 471K-T [CHN-01]		
C74	4030017730	S.CER C1005 JB 1H 471K-T	B	11.2/50.5
C75	4030019560	S.CER GRM21BB31C106KE15L	T	61.6/25.3
C76	4030016790	S.CER C1005 JB 1E 103K-T	T	57.8/54.9
C77	4030017460	S.CER C1005 JB 1H 102K-T	T	56.8/50.7
C78	4030017730	S.CER C1005 JB 1H 471K-T	B	58.8/56.6
C79	4030017900	S.CER C1005 JB 1E 123K-T [EUR-01]	T	62.4/55.0
	4030017900	S.CER C1005 JB 1E 123K-T [EXP-01]		
	4030016960	S.CER C1005 JB 1E 183K-T [USA-01]		
	4030016960	S.CER C1005 JB 1E 183K-T [EXP-03]		
	4030016960	S.CER C1005 JB 1E 183K-T [CHN-01]		
C80	4030017780	S.CER C1005 JB 1H 472K-T	T	60.6/52.1
C81	4030017460	S.CER C1005 JB 1H 102K-T	T	65.1/55.0
C82	4030011030	S.CER GRM31M4C2H1R5CY21L (GRM42-6 CK)	T	34.9/65.2
C84	4030017420	S.CER C1005 CH 1H 470J-T	T	55.0/61.6
C85	4030017460	S.CER C1005 JB 1H 102K-T	T	56.0/61.6
C86	4030017710	S.CER C1005 CH 1H 181J-T	T	81.3/63.8
C87	4030017460	S.CER C1005 JB 1H 102K-T	T	79.8/68.8
C88	4030017730	S.CER C1005 JB 1H 471K-T	T	64.6/52.1
C89	4030017580	S.CER C1005 CH 1H 060C-T	B	87.3/57.5
C90	4030017580	S.CER C1005 CH 1H 060C-T	B	88.2/57.5
C92	4030017570	S.CER C1005 CH 1H 040B-T	B	89.9/58.0
C93	4030017620	S.CER C1005 CH 1H 100C-T	B	86.9/51.5
C96	4030017460	S.CER C1005 JB 1H 102K-T	B	87.8/56.3
C97	4030017730	S.CER C1005 JB 1H 471K-T	B	87.8/55.4
C98	4030017620	S.CER C1005 CH 1H 100C-T	B	83.5/48.7
C99	4030017730	S.CER C1005 JB 1H 471K-T	B	81.4/48.3
C100	4030017620	S.CER C1005 CH 1H 100C-T	B	91.2/34.9
C102	4030017580	S.CER C1005 CH 1H 060C-T [EUR-01]	B	97.1/33.8
	4030017380	S.CER C1005 CH 1H 050B-T [EXP-01]		
	4030017380	S.CER C1005 CH 1H 050B-T [USA-01]		
	4030017380	S.CER C1005 CH 1H 050B-T [EXP-03]		
	4030017380	S.CER C1005 CH 1H 050B-T [CHN-01]		
C103	4030017350	S.CER C1005 CH 1H 020B-T [EUR-01]	B	98.5/32.2
	4030017360	S.CER C1005 CH 1H 030B-T [EXP-01]		
	4030017360	S.CER C1005 CH 1H 030B-T [USA-01]		
	4030017360	S.CER C1005 CH 1H 030B-T [EXP-03]		
	4030017360	S.CER C1005 CH 1H 030B-T [CHN-01]		
C104	4030017460	S.CER C1005 JB 1H 102K-T	B	100.8/29.9
C105	4030017730	S.CER C1005 JB 1H 471K-T	B	97.6/28.9
C106	4030017420	S.CER C1005 CH 1H 470J-T	B	91.7/48.9
C107	4030017460	S.CER C1005 JB 1H 102K-T	T	80.2/51.7
C108	4030016790	S.CER C1005 JB 1E 103K-T	B	81.3/49.2
C109	4030017460	S.CER C1005 JB 1H 102K-T	B	95.8/35.3
C110	4030017730	S.CER C1005 JB 1H 471K-T	B	98.6/35.3
C111	4030017730	S.CER C1005 JB 1H 471K-T	T	101.7/37.1
C112	4030016930	S.CER C1005 JB 1A 104K-T	T	100.8/37.1
C113	4030017540	S.CER C1005 CH 1H R75B-T	B	102.0/29.6
C114	4030017610	S.CER C1005 CH 1H 090C-T	B	98.3/26.1
C115	4030017400	S.CER C1005 CH 1H 220J-T	B	98.8/21.9
C116	4030017460	S.CER C1005 JB 1H 102K-T	B	107.5/30.0
C117	4030017730	S.CER C1005 JB 1H 471K-T	B	107.5/30.9
C118	4030017520	S.CER C1005 CH 1H 0R3B-T	B	102.8/32.0
C119	4030016790	S.CER C1005 JB 1E 103K-T	B	97.0/21.9
C120	4030017730	S.CER C1005 JB 1H 471K-T	B	97.9/21.9
C121	4030017590	S.CER C1005 CH 1H 070C-T	B	103.3/30.8
C122	4030017390	S.CER C1005 CH 1H 180J-T	B	107.5/31.8
C123	4030020040	S.CER C1005 CH 1H 200J-T	B	104.8/28.2
C124	4030017400	S.CER C1005 CH 1H 220J-T	B	105.0/20.8
C125	4030017420	S.CER C1005 CH 1H 470J-T	B	101.7/27.5
C126	4030017610	S.CER C1005 CH 1H 090C-T	B	95.6/23.7
C127	4030017410	S.CER C1005 CH 1H 240J-T	B	96.1/21.9
C128	4030017360	S.CER C1005 CH 1H 030B-T	B	99.5/27.3
C129	4030017530	S.CER C1005 CH 1H 0R5B-T	B	103.2/27.5
C131	4030017350	S.CER C1005 CH 1H 020B-T	B	106.4/27.2
C132	4030017460	S.CER C1005 JB 1H 102K-T	T	94.3/12.6
C133	4030017620	S.CER C1005 CH 1H 100C-T	B	105.4/22.7
C134	4030017620	S.CER C1005 CH 1H 100C-T	B	93.7/22.8
C135	4030016790	S.CER C1005 JB 1E 103K-T	T	78.3/21.0
C139	4030016930	S.CER C1005 JB 1A 104K-T	B	107.5/33.6
C140	4030017430	S.CER C1005 CH 1H 101J-T	B	81.2/18.9
C141	4030017460	S.CER C1005 JB 1H 102K-T	T	75.7/21.5
C143	4030017460	S.CER C1005 JB 1H 102K-T	T	78.9/22.2
C144	4030017420	S.CER C1005 CH 1H 470J-T	T	92.5/16.1
C146	4550000560	S.TAN TEESVA 1V 334M8R	T	84.7/22.9
C147	45500003250	S.TAN TEESVA 1V 474M8R	T	80.5/22.9
C148	4030019560	S.CER GRM21BB31C106KE15L	T	109.7/30.5
C151	4030016930	S.CER C1005 JB 1A 104K-T	B	75.3/18.1
C152	4030017420	S.CER C1005 CH 1H 470J-T	B	77.8/18.1
C153	4030017420	S.CER C1005 CH 1H 470J-T	B	78.1/16.2
C154	4030017420	S.CER C1005 CH 1H 470J-T	B	76.4/16.2
C155	4030017460	S.CER C1005 JB 1H 102K-T	B	81.7/16.7
C156	4030016790	S.CER C1005 JB 1E 103K-T	B	81.2/17.9

[MAIN-A UNIT] (For [Low band] versions)

REF NO.	PARTS NO.	DESCRIPTION	M.	H/V LOCATION
C157	4030017620	S.CER C1005 CH 1H 100C-T	B	72.4/24.4
C160	4030016930	S.CER C1005 JB 1A 104K-T	B	74.2/21.3
C162	4030016790	S.CER C1005 JB 1E 103K-T	B	72.4/17.7
C165	4030017460	S.CER C1005 JB 1H 102K-T	B	74.1/23.5
C192	4030017360	S.CER C1005 CH 1H 030B-T [EUR-01]	B	34.3/40.5
	4030017350	S.CER C1005 CH 1H 020B-T [EXP-01]		
	4030017350	S.CER C1005 CH 1H 020B-T [USA-01]		
	4030017350	S.CER C1005 CH 1H 020B-T [EXP-03]		
	4030017350	S.CER C1005 CH 1H 020B-T [CHN-01]		
C193	4030017340	S.CER C1005 CH 1H 010B-T	B	51.5/38.3
C277	4030016930	S.CER C1005 JB 1A 104K-T	B	36.0/28.4
C281	4030017770	S.CER C1005 JB 1H 332K-T	T	92.0/13.5
C282	4030016930	S.CER C1005 JB 1A 104K-T	T	44.2/28.0
C283	4030016930	S.CER C1005 JB 1A 104K-T	T	42.5/25.2
C284	4030016930	S.CER C1005 JB 1A 104K-T	T	44.2/28.9
C285	4030017580	S.CER C1005 CH 1H 060C-T	B	94.0/29.9
C286	4030017600	S.CER C1005 CH 1H 080C-T	B	36.4/26.3
C287	4030017460	S.CER C1005 JB 1H 102K-T	T	95.9/11.7
C298	4030017360	S.CER C1005 CH 1H 120J-T	T	86.3/29.4
C299	4030017570	S.CER C1005 CH 1H 040B-T	T	83.9/29.4
C300	4030017350	S.CER C1005 CH 1H 020B-T	T	85.1/30.8
C301	4030017730	S.CER C1005 JB 1H 471K-T	B	92.8/31.3
C302	4030017420	S.CER C1005 CH 1H 470J-T	B	80.1/39.2
C303	4030017730	S.CER C1005 JB 1H 471K-T	B	80.1/36.3
C305	4030017500	S.CER C1005 CH 1H 560J-T	B	64.8/24.2
C306	4030017580	S.CER C1005 CH 1H 060C-T	B	64.3/25.4
C307	4030017500	S.CER C1005 CH 1H 560J-T	B	61.3/22.7
C308	4030017360	S.CER C1005 CH 1H 030B-T	B	60.1/23.2
C309	4030016790	S.CER C1005 JB 1E 103K-T	B	67.4/21.2
C312	4030016930	S.CER C1005 JB 1A 104K-T	B	67.4/20.9
C314	4030016790	S.CER C1005 JB 1E 103K-T	T	110.5/33.8
C323	4030017620	S.CER C1005 CH 1H 100C-T	B	72.3/26.2
C328	4030017560	S.CER C1005 CH 1H 2R5B-T	B	85.4/55.8
C332	4030017350	S.CER C1005 CH 1H 0R5B-T	B	84.9/50.0
C333	4030017420	S.CER C1005 CH 1H 470J-T	B	80.4/40.7
C334	4030017590	S.CER C1005 CH 1H 070C-T	B	94.9/68.3
C335	4030017630	S.CER C1005 CH 1H 120J-T	B	93.8/68.3
C336	4030017710	S.CER C1005 CH 1H 181J-T	B	62.0/68.7
C337	4030017460	S.CER C1005 JB 1H 102K-T	T	82.7/29.2
C340	4030017710	S.CER C1005 CH 1H 181J-T	T	107.7/28.7
C342	4550002980	S.TAN TEESVA 1C 225M8R	B	78.4/62.1
C343	4030017460	S.CER C1005 JB 1H 102K-T	B	51.5/39.2
C344	4030017460	S.CER C1005 JB 1H 102K-T	B	54.2/68.0
C345	4030017730	S.CER C1005 JB 1H 471K-T	B	54.2/67.1
C346	4030017420	S.CER C1005 CH 1H 470J-T	B	66.0/68.7
C347	4030017460	S.CER C1005 JB 1H 102K-T	T	52.2/22.9
C348	4030017460	S.CER C1005 JB 1H 102K-T	T	59.3/20.5
C350	4030017920	S.CER C1005 JB 1A 683K-T	T	95.9/14.4
C357	4030016930	S.CER C1005 JB 1A 104K-T	T	103.5/34.7
C358	4030017340	S.CER C1005 CH 1H 010B-T	B	91.2/35.8
C366	4030017460	S.CER C1005 JB 1H 102K-T	B	97.0/64.4
C367	4030017730	S.CER C1005 JB 1H 471K-T	B	97.0/65.8
C368	4030017420	S.CER C1005 CH 1H 470J-T	B	97.0/67.3
C372	4030017730	S.CER C1005 JB 1H 471K-T	T	60.3/67.7
C376	4030017730	S.CER C1005 JB 1H 471K-T	B	88.7/49.5
C377	4030017460	S.CER C1005 JB 1H 102K-T	T	57.8/61.6
C383	4030018860	S.CER C1005 JB 0J 105K-T	T	36.4/36.2
C384	4030016930	S.CER C1005 JB 1A 104K-T	T	59.3/29.0
C385	4030016930	S.CER C1005 JB 1A 104K-T	B	54.9/28.9
C388	4030017730	S.CER C1005 JB 1H 471K-T	B	68.2/36.7
C390	4030017460	S.CER C1005 JB 1H 102K-T	B	75.0/40.6
C391	4030017420	S.CER C1005 CH 1H 470J-T	B	75.9/40.6
C392	4030017530	S.CER C1005 CH 1H 0R5B-T	B	60.3/39.2
C393	4030017350	S.CER C1005 CH 1H 020B-T	B	66.3/40.5
C394	4030016930	S.CER C1005 JB 1A 104K-T	B	50.9/28.8
C395	4030016930	S.CER C1005 JB 1A 104K-T	B	45.1/29.0
C396	4030016930	S.CER C1005 JB 1A 104K-T	T	55.8/29.0
C397	4030016790	S.CER C1005 JB 1E 103K-T	B	50.4/12.7
C398	4030016790	S.CER C1005 JB 1E 103K-T	B	48.6/27.3
C399	4030016790	S.CER C1005 JB 1E 103K-T	B	48.3/28.5
C400	4030017710	S.CER C1005 CH 1H 181J-T	T	81.2/37.6
C401	4030017570	S.CER C1005 CH 1H 040B-T	B	78.6/40.6
C402	4030011060	S.CER GRM31M2C2H4R0CY21L (GRM42-6 CH)	B	38.0/68.7
C				

[MAIN-A UNIT] (For [Low band] versions)

REF NO.	PARTS NO.	DESCRIPTION	M.	H/V LOCATION
C466	4030017420	S.CER C1005 CH 1H 470J-T	T	62.7/49.8
C467	4030017420	S.CER C1005 CH 1H 470J-T	T	88.4/10.4
C471	4030017420	S.CER C1005 CH 1H 470J-T	B	103.7/19.2
C494	4030018860	S.CER C1005 JB 0J 105K-T	T	37.3/36.2
C624	4030017460	S.CER C1005 JB 1H 102K-T	B	81.2/26.7
C625	4030019990	S.CER C1005 JB 1C 104K-T	B	63.3/16.4
C626	4030017430	S.CER C1005 CH 1H 101J-T	B	59.9/20.5
C627	4030018910	S.CER C1608 JB 0J 475K-T	B	57.7/19.6
C628	4030017590	S.CER C1005 CH 1H 070C-T	T	63.3/36.2
C629	4030017530	S.CER C1005 CH 1H 0R5B-T	T	66.8/29.7
C630	4030016790	S.CER C1005 JB 1E 103K-T	T	66.8/28.8
C631	4030016790	S.CER C1005 JB 1E 103K-T	T	68.6/41.6
C632	4030016790	S.CER C1005 JB 1E 103K-T	T	76.5/41.6
C633	4030016930	S.CER C1005 JB 1A 104K-T	T	81.3/43.1
C634	4030016930	S.CER C1005 JB 1A 104K-T	T	80.0/41.2
C635	4030016790	S.CER C1005 JB 1E 103K-T	T	71.5/29.7
C637	4030017600	S.CER C1005 CH 1H 080C-T	T	72.3/36.2
C638	4030017460	S.CER C1005 JB 1H 102K-T	T	83.5/42.2
C639	4030016930	S.CER C1005 JB 1A 104K-T	T	46.8/25.7
C640	4030017040	S.CER C1005 JB 1A 333K-T	B	38.8/24.4
C641	4030018890	S.CER C1005 JB 0J 224K-T	B	76.3/27.1
C642	4030018890	S.CER C1005 JB 0J 224K-T	B	77.5/27.0
C643	4030017430	S.CER C1005 CH 1H 101J-T	B	77.5/27.9
C644	4030019560	S.CER GRM21BB31C106KE15L	B	81.7/20.4
C645	4030016930	S.CER C1005 JB 1A 104K-T	B	30.0/15.7
C646	4030017460	S.CER C1005 JB 1H 102K-T	T	84.7/10.0
C647	4030016790	S.CER C1005 JB 1E 103K-T	B	59.1/27.7
C1003	4030017460	S.CER C1005 JB 1H 102K-T	T	133.3/63.5
C1005	4030018980	S.CER C1608 JB 1H 104K-T	B	100.1/11.8
C1007	4030017460	S.CER C1005 JB 1H 102K-T	T	100.1/12.1
C1008	4510009680	S.ELE EEEFK1E471P	B	110.2/52.6
C1010	4030017460	S.CER C1005 JB 1H 102K-T	B	106.5/59.0
C1011	4030016930	S.CER C1005 JB 1A 104K-T	B	93.9/12.1
C1012	4030017420	S.CER C1005 CH 1H 470J-T	B	117.5/16.6
C1014	4030017460	S.CER C1005 JB 1H 102K-T	T	116.6/27.5
C1015	4030017460	S.CER C1005 JB 1H 102K-T	T	114.9/8.0
C1017	4030017460	S.CER C1005 JB 1H 102K-T	B	122.5/64.9
C1018	4030017460	S.CER C1005 JB 1H 102K-T	T	133.3/45.0
C1019	4510009250	S.ELE EEEFK1C471P	B	130.5/34.8
C1022	4030017420	S.CER C1005 CH 1H 470J-T	B	105.5/59.0
C1023	4030017460	S.CER C1005 JB 1H 102K-T	B	114.9/58.8
C1024	4030017440	S.CER C1005 CH 1H 221J-T	B	113.4/59.7
C1025	4030017510	S.CER C1005 CH 1H 680J-T	B	113.4/60.6
C1026	4030019120	S.CER GRM188B31E105KA75D	T	115.8/49.5
C1028	4030017460	S.CER C1005 JB 1H 102K-T	B	117.4/6.1
C1029	4030017460	S.CER C1005 JB 1H 102K-T	T	114.9/12.6
C1031	4030017460	S.CER C1005 JB 1H 102K-T	T	115.0/16.9
C1032	4030016930	S.CER C1005 JB 1A 104K-T	B	123.6/16.6
C1033	4510009680	S.ELE EEEFK1E471P	B	120.0/29.1
C1034	4030018860	S.CER C1005 JB 0J 105K-T	B	131.6/16.6
C1035	4030016790	S.CER C1005 JB 1E 103K-T	B	131.6/18.7
C1036	4030018980	S.CER C1608 JB 1H 104K-T	T	128.4/46.9
C1037	4030019560	S.CER GRM21BB31C106KE15L	B	129.4/43.4
C1038	4030011600	S.CER C1608 JB 1E 104K-T	T	110.5/48.7
C1039	4510009680	S.ELE EEEFK1E471P	B	117.0/22.4
C1040	4030019560	S.CER GRM21BB31C106KE15L	B	116.7/22.2
C1042	4030016930	S.CER C1005 JB 1A 104K-T	B	118.1/22.4
C1043	4030016930	S.CER C1005 JB 1A 104K-T	T	114.9/16.0
C1045	4030017460	S.CER C1005 JB 1H 102K-T	T	114.9/14.2
C1046	4030018860	S.CER C1005 JB 0J 105K-T	T	114.9/15.1
C1048	4030018900	S.CER C1005 JB 0J 474K-T	B	126.7/18.6
C1050	4030018860	S.CER C1005 JB 0J 105K-T	B	125.2/16.6
C1051	4030017460	S.CER C1005 JB 1H 102K-T	B	122.1/48.2
C1052	4030016930	S.CER C1005 JB 1A 104K-T	T	127.8/40.1
C1053	4030019560	S.CER GRM21BB31C106KE15L	T	127.8/44.5
C1056	4030018860	S.CER C1005 JB 0J 105K-T	T	111.2/11.7
C1057	4030016930	S.CER C1005 JB 1A 104K-T	B	118.7/17.1
C1058	4030019560	S.CER GRM21BB31C106KE15L	T	105.5/44.4
C1059	4030017460	S.CER C1005 JB 1H 102K-T	T	107.7/46.3
C1060	4030017460	S.CER C1005 JB 1H 102K-T	B	126.2/39.8
C1061	4030017460	S.CER C1005 JB 1H 102K-T	T	107.7/37.4
C1062	4030017460	S.CER C1005 JB 1H 102K-T	B	120.7/22.9
C1063	4030019560	S.CER GRM21BB31C106KE15L	B	126.9/22.2
C1064	4030019560	S.CER GRM21BB31C106KE15L	B	121.6/36.0
C1065	4030017460	S.CER C1005 JB 1H 102K-T	B	120.2/35.6
C1066	4030018860	S.CER C1005 JB 0J 105K-T	B	125.6/38.1
C1070	4030017440	S.CER C1005 CH 1H 221J-T	B	120.4/16.2
C1071	4030016930	S.CER C1005 JB 1A 104K-T	B	120.4/10.8
C1074	4030017460	S.CER C1005 JB 1H 102K-T	B	73.9/10.4
C1075	4030017460	S.CER C1005 JB 1H 102K-T	B	70.7/14.4
C1076	4030017460	S.CER C1005 JB 1H 102K-T	B	69.7/14.4
C1077	4030017460	S.CER C1005 JB 1H 102K-T	B	68.8/14.4
C1080	4030016790	S.CER C1005 JB 1E 103K-T	B	51.1/15.3
C1081	4030016930	S.CER C1005 JB 1A 104K-T	B	117.2/15.2
C1082	4030016930	S.CER C1005 JB 1A 104K-T	B	114.8/14.6
C1083	4030017460	S.CER C1005 JB 1H 102K-T	T	37.6/19.3
C1084	4030017710	S.CER C1005 CH 1H 181J-T	B	41.9/20.8
C1085	4030017460	S.CER C1005 JB 1H 102K-T	T	76.3/14.6
C1092	4030016930	S.CER C1005 JB 1A 104K-T	B	75.8/14.4
C1095	4030016930	S.CER C1005 JB 1A 104K-T	T	38.5/19.3
C1096	4030018860	S.CER C1005 JB 0J 105K-T	T	51.7/18.5
C1097	4030018240	S.CER C1005 JB 1H 562K-T	B	50.8/17.8
C1098	4030018860	S.CER C1005 JB 0J 105K-T	T	54.5/16.3
C1099	4030018860	S.CER C1005 JB 0J 105K-T	B	45.2/20.8
C1100	4030017460	S.CER C1005 JB 1H 102K-T	B	75.8/9.1
C1101	4030017420	S.CER C1005 CH 1H 470J-T	T	78.2/8.0
C1102	4030016930	S.CER C1005 JB 1A 104K-T	[EUR-01] [EXP-01]	
C1103	4030016930	S.CER C1005 JB 1A 104K-T	[USA-01]	
C1104	4030016930	S.CER C1005 JB 1A 104K-T	[EXP-03] [CHN-01]	
C1105	4030017420	S.CER C1005 CH 1H 470J-T	B	71.6/6.6
C1106	4030016930	S.CER C1005 JB 1A 104K-T	T	36.3/20.6
C1107	4030017440	S.CER C1005 CH 1H 221J-T	B	33.1/15.2
C1108	4030017450	S.CER C1005 JB 1H 271K-T	B	39.2/13.5

[MAIN-A UNIT] (For [Low band] versions)

REF NO.	PARTS NO.	DESCRIPTION	M.	H/V LOCATION
C1109	4030018860	S.CER C1005 JB 0J 105K-T	T	42.5/18.0
C1110	4030018860	S.CER C1005 JB 0J 105K-T	T	42.5/20.4
C1111	4030018860	S.CER C1005 JB 0J 105K-T	B	46.6/19.1
C1112	4030016930	S.CER C1005 JB 1A 104K-T	B	45.7/19.1
C1119	4030017420	S.CER C1005 CH 1H 470J-T	B	65.2/6.9
C1127	4030017660	S.CER C1005 CH 1H 330J-T	B	36.6/21.2
C1128	4030016930	S.CER C1005 JB 1A 104K-T	B	31.3/13.6
C1129	4030016930	S.CER C1005 JB 1A 104K-T	B	32.2/16.9
C1130	4030017900	S.CER C1005 JB 1E 123K-T	B	37.4/13.5
C1131	4550006970	S.TAN TEESVA0G476M8R	T	53.5/12.1
C1132	4030017460	S.CER C1005 JB 1H 102K-T	T	51.8/13.0
C1133	4030016790	S.CER C1005 JB 1E 103K-T	T	78.2/5.7
C1135	4030017460	S.CER C1005 JB 1H 102K-T	T	73.9/16.8
C1136	4030016930	S.CER C1005 JB 1A 104K-T	T	71.6/15.5
C1137	4030016780	S.CER C1005 JB 1E 153K-T	[EUR-01] [EXP-01] [USA-01] [EXP-03] [CHN-01]	B 40.1/20.8
C1138	4030017460	S.CER C1005 JB 1H 102K-T	T	37.7/15.7
C1139	4030017920	S.CER C1005 JB 1A 683K-T	T	52.5/17.2
C1140	4030017400	S.CER C1005 JB 1A 333K-T	B	54.0/18.3
C1141	4030016790	S.CER C1005 JB 1E 103K-T	B	42.4/17.3
C1142	4030016930	S.CER C1005 JB 1A 104K-T	B	117.6/11.8
C1143	4030018980	S.CER C1608 JB 1H 104K-T	B	93.8/9.4
C1144	4030016930	S.CER C1005 JB 1A 104K-T	B	41.7/15.1
C1145	4030018090	S.CER C1005 JB 1E 822K-T	B	42.8/20.8
C2001	4050000240	S.FEE NFM18PC104R1C3D	T	39.3/10.9
C2002	4030016930	S.CER C1005 JB 1A 104K-T	B	34.9/5.4
C2004	4550007730	S.TAN TEESVJ 0J 106M8R	B	35.3/7.2
C2007	4030018910	S.CER C1608 JB 0J 475K-T	B	18.4/10.0
C2008	4030016930	S.CER C1005 JB 1A 104K-T	B	16.1/8.9
C2009	4050000240	S.FEE NFM18PC104R1C3D	B	28.0/5.9
C2010	4050000240	S.FEE NFM18PC104R1C3D	B	12.3/5.5
C2011	4030019460	S.CER C1608 JB 0J 106M-T	T	33.0/6.9
C2012	4030016930	S.CER C1005 JB 1A 104K-T	B	26.4/5.8
C2013	4550007730	S.TAN TEESVJ 0J 106M8R	B	25.0/6.2
C2014	4030016930	S.CER C1005 JB 1A 104K-T	T	31.7/6.6
C2015	4030016930	S.CER C1005 JB 1A 104K-T	B	10.1/6.4
C2016	4550007720	S.TAN TEESVJ 0G 476M8R	T	26.7/7.1
C2017	4550007730	S.TAN TEESVJ 0J 106M8R	B	17.2/9.2
C2018	4030016930	S.CER C1005 JB 1A 104K-T	B	9.2/6.4
C2019	4030016790	S.CER C1005 JB 1E 103K-T	B	14.8/19.3
C2021	4030018910	S.CER C1608 JB 0J 475K-T	B	16.0/21.6
C2022	4030018910	S.CER C1608 JB 0J 475K-T	B	13.5/14.5
C2023	4030016790	S.CER C1005 JB 1E 103K-T	B	23.1/14.3
C2024	4030018860	S.CER C1005 JB 0J 105K-T	B	21.2/14.1
C2025	4030017420	S.CER C1005 CH 1H 470J-T	B	20.8/11.1
C2026	4030017460	S.CER C1005 JB 1H 102K-T	B	20.8/10.2
C2027	4030018910	S.CER C1608 JB 0J 475K-T	B	10.9/10.0
C2028	4030018860	S.CER C1005 JB 0J 105K-T	T	11.5/10.2
C2031	4030018860	S.CER C1005 JB 0J 105K-T	T	20.9/11.3
C2032	4030016930	S.CER C1005 JB 1A 104K-T	T	13.1/11.7
C2033	4030018860	S.CER C1005 JB 0J 105K-T	B	15.1/17.7
C2034	4030016930	S.CER C1005 JB 1A 104K-T	T	11.9/7.9
C2035	4030018910	S.CER C1608 JB 0J 475K-T	T	10.2/8.2
C2036	4030018860	S.CER C1005 JB 0J 105K-T	B	21.1/20.9
C2038	4030016790	S.CER C1005 JB 1E 103K-T	B	16.4/25.3
C2039	4030017430	S.CER C1005 CH 1H 101J-T	B	19.7/7.5
C2040	4030016790	S.CER C1005 JB 1E 103K-T	T	26.4/18.1
C2041	4030018910	S.CER C1608 JB 0J 475K-T	T	11.1/14.5
C2042	4030016930	S.CER C1005 JB 1A 104K-T	T	10.1/14.8
C2044	4030016790	S.CER C1005 JB 1E 103K-T	T	26.4/19.9
C2045	4030016930	S.CER C1005 JB 1A 104K-T	B	26.6/23.4
C2046	4030016930	S.CER C1005 JB 1A 104K-T	B	26.6/24.3
C2047	4030016930	S.CER C1005 JB 1A 104K-T	B	26.6/20.7
C2048	4030016930	S.CER C1005 JB 1A 104K-T	B	26.6/22.5
C2049	4030017420	S.CER C1005 CH 1H 470J-T	B	25.7/9.5
C2050	4030017620	S.CER C1005 CH 1H 100C-T	B	26.7/15.8
C2051	4030016930	S.CER C1005 JB 1A 104K-T	B	13.6/29.4
C2052	4030016930	S.CER C1005 JB 1A 104K-T	B	25.5/15.3
C2053	4030017460	S.CER C1005 JB 1H 102K-T	B	27.4/10.4
C2054	4030016930	S.CER C1005 JB 1A 104K-T	T	25.5/12.4
C2055	403			

[MAIN-A UNIT] (For [Low band] versions)

REF NO.	PARTS NO.	DESCRIPTION	M.	H/V LOCATION
J1003	6510022891	S.CON B13B-ZR-SM4-TF(LF)(SN)	T	120.0/17.2
J1004	6510027960	S.CON 04-6294-040-000-800	T	67.5/10.6
S1001	2260003180	S.SWI MINISMD050F-2 CN	T	114.1/33.8
W1	7030012290	JUM RDS2T0R0		
W2	8900011863	CAB OPC-1195C <TJM>		
EP1	6910018460	S.BEA MMZ1005Y102C-T	B	107.5/32.7
EP4	6910010280	BEA HF70BB9.5X10.4X4.9		
EP5	6910010280	BEA HF70BB9.5X10.4X4.9		
EP7	6910018460	S.BEA MMZ1005Y102C-T	B	74.2/19.4
EP8	6910018460	S.BEA MMZ1005Y102C-T	B	80.8/16.7
EP13	6910018460	S.BEA MMZ1005Y102C-T	B	100.1/25.3
EP14	6910011560	BEA HF70BB4.5X5X1.6		
EP15	6910011560	BEA HF70BB4.5X5X1.6		
EP2001	6910016330	S.BEA MMZ1005S 601CT-S	B	22.8/5.3
EP2003	6910016330	S.BEA MMZ1005S 601CT-S	T	9.1/7.0
EP2004	6910016330	S.BEA MMZ1005S 601CT-S	T	32.7/9.0
EP2005	6910016330	S.BEA MMZ1005S 601CT-S	B	24.6/23.8
EP2007	6910016330	S.BEA MMZ1005S 601CT-S	T	10.8/6.2

[MAIN-B UNIT] (For [High band] versions)

REF NO.	PARTS NO.	DESCRIPTION	M.	H/V LOCATION
IC2	1110002751	S.IC TA75S01F(TE85RF)	T	60.0/54.9
IC3	1150002390	IC RA30H4452M1-101 [EXP-02]		
	1150002410	IC RA60H4452M1-121 [USA-02]		
	1150002410	IC RA60H4452M1-121 [EXP-04]		
IC4	1110007320	S.IC NJM2591V-TE1-#ZZZB	T	57.8/24.7
IC5	1110006230	S.IC NJM2711F-TE1-#ZZZB	B	38.8/27.0
IC6	1110002751	S.IC TA75S01F(TE85RF)	B	59.9/17.4
IC7	1130011741	S.IC TC7W66FK(TE85LF)	T	85.8/12.3
IC8	1130015271	S.IC AK1541P4-L	B	78.2/23.7
IC1001	1180003660	S.REG XC6408EN22PR-G	B	96.9/10.8
IC1002	1180003500	S.REG NJM7808DL1A-TE1-#FZZB	T	123.3/45.7
IC1004	1110002751	S.IC TA75S01F(TE85RF)	B	119.7/13.0
IC1005	1110007630	S.IC NJM2783V-TE1-#ZZZH	T	47.4/18.9
IC1006	1110007290	S.IC AK2330P-L	B	53.7/11.5
IC1007	1110005320	S.IC NJM13403V-TE1-#ZZZB	B	37.4/17.0
IC1008	1130009981	S.IC TC7W53FK(TE85LF)	T	40.3/19.7
IC1009	1110003091	IC LA4425A-E		
IC2001	1180003680	S.REG TPS62204DBVR	B	32.4/6.5
IC2002	1190002900	S.IC ADS7886SDCKR	B	14.4/9.3
IC2006	1110007770	S.IC PCM3008T/2K	T	16.3/8.3
IC2007	1140013290	S.IC TMS320VC5509AZHH	T	18.0/18.4
IC2008	1130015620	S.IC EN25Q40-100GIP <MSK>	B	12.5/25.3
IC2009	1110006230	S.IC NJM2711F-TE1-#ZZZB	B	26.7/12.7
IC2010	1180003600	S.REG NJM2871BF05-TE1-#ZZZB	B	39.0/6.8
Q1	1590004090	S.TRA LDT114YET1G <SLVJ>	B	47.2/27.1
Q2	1580000731	S.FET 3SK293(TE85LF)	B	41.5/38.7
Q3	1560000541	S.FET 2SK880-Y(T5RICOMF)	T	77.2/24.5
Q4	1530002851	S.TRA 2SC4116-BL(TE85RF)	B	67.9/25.4
Q5	1530002851	S.TRA 2SC4116-BL(TE85RF)	T	44.9/25.3
Q6	1590004090	S.TRA LDT114YET1G <SLVJ>	T	62.2/52.2
Q7	1560000841	S.FET 2SK1829(TE85RF)	T	33.7/39.7
Q8	1530002680	S.TRA 2SC3357-T1	B	90.4/52.8
Q9	1560001360	S.FET 2SK3019 TL	T	52.2/26.3
Q10	1530003311	S.TRA 2SC5107-O(TE85RF)	B	92.8/33.1
Q11	1530003311	S.TRA 2SC5107-O(TE85RF)	B	100.5/31.7
Q12	1530004110	S.TRA MT3S37T(TE85LF)	B	97.6/30.4
Q13	1590004090	S.TRA LDT114YET1G <SLVJ>	B	57.6/27.2
Q14	1530003311	S.TRA 2SC5107-O(TE85RF)	T	64.8/24.9
Q15	1590004500	S.TRA DMC561040R	T	101.0/34.4
Q17	1530002851	S.TRA 2SC4116-BL(TE85RF)	T	107.7/33.4
Q18	1590004090	S.TRA LDT114YET1G <SLVJ>	T	81.5/40.8
Q19	1580000731	S.FET 3SK293(TE85LF)	B	71.4/38.4
Q20	1530002851	S.TRA 2SC4116-BL(TE85RF) [USA-02]	T	60.0/49.8
	1530002851	S.TRA 2SC4116-BL(TE85RF) [EXP-04]		
Q21	1590004090	S.TRA LDT114YET1G <SLVJ>	B	49.5/24.8
Q23	1530002921	S.TRA 2SC4226-T1 Y25 (R25)	T	105.2/30.9
Q24	1530002921	S.TRA 2SC4226-T1 Y25 (R25)	B	98.3/24.2
Q25	1530003260	S.TRA 2SC5006-T1	B	84.9/51.5
Q1001	1590004090	S.TRA LDT114YET1G <SLVJ>	T	110.6/44.1
Q1003	1550000190	S.FET 2SJ506STR-E	T	115.3/45.4
Q1004	1590004090	S.TRA LDT114YET1G <SLVJ>	T	114.0/26.7
Q1005	1590004090	S.TRA LDT114YET1G <SLVJ>	T	114.0/24.7
Q1007	1590004090	S.TRA LDT114YET1G <SLVJ>	B	116.3/8.1
Q1008	1590000990	S.TRA DTC363EK T146	B	128.9/17.8
Q1009	1590001451	S.FET 2SJ144-GR (TE85RF)	B	113.8/11.1
Q1010	1590004090	S.TRA LDT114YET1G <SLVJ>	B	116.1/10.9
Q1011	1540000550	S.TRA 2SD1664 T100Q	B	125.1/47.6
Q1012	1590004090	S.TRA LDT114YET1G <SLVJ>	B	130.9/20.7
Q1013	1510000920	S.TRA 2SA1577 T106 Q	T	107.7/44.3
Q1014	1520000460	S.TRA 2SB1132 T100 R	B	123.5/21.1
Q1015	1590004590	S.TRA DMC506010R	B	118.9/20.4
Q1016	1590004090	S.TRA LDT114YET1G <SLVJ>	T	107.8/39.2
Q1017	1520000460	S.TRA 2SB1132 T100 R	T	120.1/35.2
Q1018	1590004090	S.TRA LDT114YET1G <SLVJ>	B	126.4/43.3
Q1019	1590004590	S.TRA DMC506010R	B	123.8/35.8
Q1020	1590004090	S.TRA LDT114YET1G <SLVJ>	T	42.6/22.5
Q1021	1590004090	S.TRA LDT114YET1G <SLVJ>	B	126.4/41.3
Q2001	1590004040	S.TRA LDTA123YET1G <SLVJ>	B	26.9/26.6
D2	1750001910	S.DIO HVD144AKRF-E	B	52.6/28.5
D3	1750001910	S.DIO HVD144AKRF-E	B	52.6/27.3
D4	1750000711	S.VAR HVC350BTRF-E	B	36.0/40.2
D5	1750002060	S.DIO RN752TE-21	T	26.5/53.3
D7	1750001910	S.DIO HVD144AKRF-E	B	25.3/45.3
D8	1750001910	S.DIO HVD144AKRF-E	B	43.4/27.3
D9	1750001910	S.DIO HVD144AKRF-E	B	43.4/28.6
D10	1750000711	S.VAR HVC350BTRF-E	B	55.5/39.9
D11	1750001820	S.DIO LRB706F-40T1G <SLVJ>	B	8.2/49.9
D12	1750001820	S.DIO LRB706F-40T1G <SLVJ>	B	22.8/49.9
D13	1750001910	S.DIO HVD144AKRF-E	T	68.3/28.1
D14	1750001910	S.DIO HVD144AKRF-E	T	69.5/28.1
D15	1790001261	S.DIO MA2S077GOL	B	82.2/39.2
D16	1750000711	S.VAR HVC350BTRF-E	B	106.7/20.3
D17	1750001910	S.DIO HVD144AKRF-E	T	70.6/41.6
D18	1750001910	S.DIO HVD144AKRF-E	T	74.5/41.6
D19	1750000711	S.VAR HVC350BTRF-E	B	61.9/39.9
D20	1750000711	S.VAR HVC350BTRF-E	B	28.0/40.2
D21	1750000711	S.VAR HVC350BTRF-E	B	36.0/41.6
D22	1750000711	S.VAR HVC350BTRF-E	B	28.0/41.6
D23	1750000711	S.VAR HVC350BTRF-E	B	52.8/42.6
D24	1750002060	S.DIO RN752TE-21	T	35.1/56.7
D25	1750000581	S.DIO 1SV307(TPH3F)	B	83.5/42.1
D26	1750001650	S.VAR 1SV309(TPH3F)	B	101.8/25.9
D29	1750001820	S.DIO LRB706F-40T1G <SLVJ>	B	19.2/49.9
D33	1750000711	S.VAR HVC350BTRF-E	B	97.8/20.5
D62	1750000711	S.VAR HVC350BTRF-E	B	91.7/22.8
D64	1750000711	S.VAR HVC350BTRF-E	B	106.7/21.5
D66	1750000370	S.DIO DA221 TL	T	33.7/37.1
D67	1750002170	S.DIO DB2S31400L	T	31.8/39.7
D1002	1790000700	DIO DSA3A1		
D1003	1750000370	S.DIO DA221 TL	B	114.0/8.2
D1004	1750000370	S.DIO DA221 TL	B	114.1/6.1

M.=Mounted side (T: Mounted on the Top side, B: Mounted on the Bottom side)
S.=Surface mount

[MAIN-B UNIT] (For [High band] versions)

REF NO.	PARTS NO.	DESCRIPTION	M.	H/V LOCATION
D1005	1750000370	S.DIO DA221 TL	T	113.2/7.4
D1006	1750000370	S.DIO DA221 TL	T	113.0/10.3
D1007	1750001810	S.DIO L1SS400T1G <SLVJ>	B	129.0/20.7
D1008	1750000370	S.DIO DA221 TL	B	124.0/43.3
D2002	1750002170	S.DIO DB2S31400L	T	24.9/18.0
D2003	1750002170	S.DIO DB2S31400L	B	10.7/30.5
D2004	1750002170	S.DIO DB2S31400L	B	22.1/21.4
D2005	1750002170	S.DIO DB2S31400L	B	17.5/26.3
D2006	1750002170	S.DIO DB2S31400L	T	12.0/25.3
D2008	1750002020	S.DIO DA2S10100L	T	100.3/6.5
F11	2020002570	CER LTM450HW <JJE>		
F12	2020002410	CER LTM450FW <JJE>		
F13	2020002610	S.CER LTUCG450G <JJE>	T	36.3/28.0
F14	2030000870	S.MON MFT46.3P3 46.350 MHz (FL-442)	T	66.9/34.9
F15	2010002760	S.XTA MFT46.3J 46.350 MHz (FL-448)	T	75.8/32.9
F16	2040001440	S.LC NFE31PT152Z1E9L (NFM60R20T152)	B	97.7/62.2
F17	2040001440	S.LC NFE31PT152Z1E9L (NFM60R20T152)	B	97.7/58.9
F18	2040001440	S.LC NFE31PT152Z1E9L (NFM60R20T152) [USA-02]	B	97.7/55.4
	2040001440	S.LC NFE31PT152Z1E9L (NFM60R20T152) [EXP-04]		
X1	6070000300	S.DIS JTBM450CX24 <JJE>	B	51.4/22.5
X2	6050013000	S.XTA CR-892 TT514VSB-A8 15.3 MHz	B	71.5/21.0
X2001	6050013170	S.XTA CR-914 TT518VSE-A11 12.288 MHz	B	27.0/18.2
L1	6200010150	S.COI AS080340-15N	B	8.4/62.7
L2	6200010150	S.COI AS080340-15N	B	12.9/55.5
L3	6200010150	S.COI AS080340-15N	B	20.7/55.5
L4	6200013100	S.COI 0.45-1.5-STL 18.3N <COMO>	T	31.1/50.5
L5	6200010420	S.COI FHW1210HC 1R0JGT <JJE>	T	38.5/58.4
L6	6200010150	S.COI AS080340-15N	B	27.3/55.5
L7	6200012870	S.COI 0.30-1.4-5TR 23.5N <COMO>	B	28.8/37.8
L8	6200012870	S.COI 0.30-1.4-5TR 23.5N <COMO>	B	35.2/37.8
L9	6200012170	S.COI MLG1608S R18J-T	B	65.8/24.7
L10	6200011460	S.COI C2520C-10NG-A	B	49.0/39.8
L11	6200011460	S.COI C2520C-10NG-A	B	57.8/40.5
L12	6200012170	S.COI MLG1608S R18J-T	B	62.3/22.4
L13	6200007901	S.COI ELJRF 22NJFB	T	85.1/29.9
L16	6200010150	S.COI AS080340-15N	B	38.2/65.2
L18	6200005681	S.COI ELJRE 15NGFA	B	88.1/58.9
L19	6200005701	S.COI ELJRE 22NGFA	B	89.9/56.0
L20	6200010090	S.COI ELJRD R82JF	B	68.9/40.9
L21	6200005701	S.COI ELJRE 22NGFA	B	90.8/33.1
L22	6200005701	S.COI ELJRE 22NGFA	B	99.5/33.8
L23	6200005661	S.COI ELJRE 10NGFA	B	84.9/53.2
L27	6200007370	S.COI ELJFC R82K-F	B	103.2/21.4
L28	6200011860	S.COI LQW18ANR47G00D	T	94.7/17.3
L36	6200006991	S.COI ELJRE 56NGFA	B	73.5/38.5
L37	6200006981	S.COI ELJRE 10GFCA	T	82.6/62.9
L38	6200014300	S.COI C36-4.7J <COMO>	B	106.2/24.9
L39	6200013710	S.COI C36-8NH <COMO>	B	92.9/20.2
L41	6200005711	S.COI ELJRE 27NGFA	B	95.8/29.8
L53	6200005721	S.COI ELJRE 33NGFA	B	78.0/39.2
L54	6200007370	S.COI ELJFC R82K-F	T	100.0/30.4
L55	6200002851	S.COI NLV25T-R82J	B	103.7/33.8
L56	6200011460	S.COI C2520C-10NG-A	B	64.2/40.5
L57	6200011860	S.COI LQW18ANR47G00D	B	92.6/20.4
L58	6200011860	S.COI LQW18ANR47G00D	B	105.9/19.1
L1001	6200004660	S.COI MLF1608A 1R8K-T	T	79.8/13.3
L2001	6200014160	S.COI VLCF4028T-100M1R0-2	T	35.9/7.6
L2002	6200007830	S.COI ELJFC 4R7K-F	B	31.2/11.2
R1	7030000620	S.RES MCR10EZHZ 100 K (104)	B	12.3/65.5
R4	7030003560	S.RES ERJ3GEYJ 103 V (10K)	B	16.4/50.6
R5	7030005220	S.RES ERJ2GEJ 223 X (22K)	B	11.2/49.6
R6	7030005220	S.RES ERJ2GEJ 223 X (22K)	B	19.8/48.1
R7	7030003560	S.RES ERJ3GEYJ 103 V (10K)	B	8.2/53.2
R8	7030006070	S.RES ERJ12YJ101U (100)	B	45.7/51.9
R9	7030003560	S.RES ERJ3GEYJ 103 V (10K)	B	25.6/50.6
R10	7030005220	S.RES ERJ2GEJ 223 X (22K)	B	22.2/48.1
R11	7030005050	S.RES ERJ2GEJ 103 X (10K)	B	31.5/40.5
R12	7030004980	S.RES ERJ2GEJ 101 X (100)	B	39.2/39.5
R13	7030005050	S.RES ERJ2GEJ 103 X (10K)	B	32.5/40.5
R14	7030005050	S.RES ERJ2GEJ 103 X (10K)	B	32.5/38.8
R15	7030005700	S.RES ERJ2GEJ 274 X (270K)	B	39.2/38.6
R16	7030004990	S.RES ERJ2GEJ 221 X (220)	B	39.5/40.7
R17	7030005530	S.RES ERJ2GEJ 100 X (10)	B	51.5/40.2
R18	7030005050	S.RES ERJ2GEJ 103 X (10K)	B	60.8/40.5
R19	7030005090	S.RES ERJ2GEJ 104 X (100K)	B	39.2/36.8
R20	7030005120	S.RES ERJ2GEJ 102 X (1K)	B	52.8/38.6
R21	7030005050	S.RES ERJ2GEJ 103 X (10K)	B	54.1/40.2
R22	7030005050	S.RES ERJ2GEJ 103 X (10K)	B	56.2/37.4
R23	7030005050	S.RES ERJ2GEJ 103 X (10K)	B	54.1/41.2
R29	7030005570	S.RES ERJ2GEJ 820 X (82)	B	74.0/40.6
R30	7030007300	S.RES ERJ2GEJ 332 X (3.3K)	B	71.3/41.2
R31	7030004980	S.RES ERJ2GEJ 101 X (100)	B	66.9/37.4
R33	7030005600	S.RES ERJ2GEJ 273 X (27K)	T	71.9/42.7
R34	7030005110	S.RES ERJ2GEJ 224 X (220K)	T	64.9/23.1
R35	7030005530	S.RES ERJ2GEJ 100 X (10)	T	69.4/22.2
R36	7030005030	S.RES ERJ2GEJ 152 X (1.5K)	B	56.2/21.7
R37	7030008400	S.RES ERJ2GEJ 182 X (1.8K)	B	56.6/25.5
R38	7030005090	S.RES ERJ2GEJ 104 X (100K)	T	61.7/17.8
R39	7030004970	S.RES ERJ2GEJ 470 X (47)	B	58.4/22.2
R40	7030005030	S.RES ERJ2GEJ 152 X (1.5K)	B	58.4/23.2
R41	7030010040	S.RES ERJ2GEJ-JPW	T	60.8/17.8
R42	7030005070	S.RES ERJ2GEJ 683 X (68K)	T	51.0/24.3

[MAIN-B UNIT] (For [High band] versions)

REF NO.	PARTS NO.	DESCRIPTION	M.	H/V LOCATION
R43	7030005000	S.RES ERJ2GEJ 471 X (470)	T	55.6/19.9
R44	7030005310	S.RES ERJ2GEJ 124 X (120K)	T	54.0/24.7
R45	7030005310	S.RES ERJ2GEJ 124 X (120K)	T	52.2/24.7
R46	7030008410	S.RES ERJ2GEJ 392 X (3.9K)	T	54.0/22.9
R48	7030008300	S.RES ERJ2GEJ 184 X (180K) [USA-02]	T	56.8/53.2
	7030008300	S.RES ERJ2GEJ 184 X (180K) [EXP-04]		
R49	7520000241	S.POS PRF18BC471QB5RB [USA-02]	T	47.3/53.2
	7520000241	S.POS PRF18BC471QB5RB [EXP-04]		
R50	7030005050	S.RES ERJ2GEJ 103 X (10K)	B	80.1/37.9
R51	7030005220	S.RES ERJ2GEJ 223 X (22K) [EXP-02]	T	61.8/49.8
	7030005080	S.RES ERJ2GEJ 823 X (82K) [USA-02]		
	7030005080	S.RES ERJ2GEJ 823 X (82K) [EXP-04]		
R52	7030005070	S.RES ERJ2GEJ 683 X (68K)	T	58.7/52.1
R53	7030004990	S.RES ERJ2GEJ 221 X (220)	T	57.8/53.2
R54	7030005220	S.RES ERJ2GEJ 223 X (22K)	B	58.8/55.7
R56	7030005110	S.RES ERJ2GEJ 224 X (220K)	T	63.3/55.0
R57	7030005050	S.RES ERJ2GEJ 103 X (10K)	B	58.8/54.8
R58	7030005570	S.RES ERJ2GEJ 820 X (82)	T	64.2/55.0
R59	7030007350	S.RES ERJ2GEJ 393 X (39K)	T	59.7/52.1
R61	7030004970	S.RES ERJ2GEJ 470 X (47)	B	90.5/49.5
R62	7030008290	S.RES ERJ2GEJ 183 X (18K)	B	89.6/49.5
R66	7030005090	S.RES ERJ2GEJ 104 X (100K)	B	84.9/49.1
R67	7030004980	S.RES ERJ2GEJ 101 X (100)	B	83.0/47.3
R68	7030005050	S.RES ERJ2GEJ 103 X (10K)	B	82.6/48.7
R69	7030005040	S.RES ERJ2GEJ 472 X (4.7K)	B	84.0/38.0
R70	7030004990	S.RES ERJ2GEJ 221 X (220)	B	92.8/35.8
R71	7030007260	S.RES ERJ2GEJ 330 X (33)	B	95.3/33.8
R72	7030004980	S.RES ERJ2GEJ 101 X (100)	B	86.5/49.1
R73	7030004980	S.RES ERJ2GEJ 101 X (100)	B	99.5/35.3
R74	7030005080	S.RES ERJ2GEJ 823 X (82K)	B	101.3/33.7
R75	7030005720	S.RES ERJ2GEJ 563 X (56K)	B	97.6/32.2
R76	7030005030	S.RES ERJ2GEJ 152 X (1.5K)	B	96.7/32.2
R77	7030005120	S.RES ERJ2GEJ 102 X (1K)	T	105.6/36.0
R78	7030009270	S.RES ERJ2GEJ 101 X (820)	T	102.5/32.5
R79	7030006020	S.RES RR0510P-682-D (6.8K)	B	96.5/23.7
R80	7030009270	S.RES ERJ2GEJ 821 X (820)	T	100.0/32.5
R83	7030006020	S.RES RR0510P-682-D (6.8K)	B	106.4/29.1
R84	7030006020	S.RES RR0510P-682-D (6.8K)	B	106.4/28.2
R85	7030006020	S.RES RR0510P-682-D (6.8K)	B	95.6/25.3
R86	7030005110	S.RES ERJ2GEJ 224 X (220K)	B	102.6/24.4
R87	7030005530	S.RES ERJ2GEJ 100 X (10)	B	102.6/27.5
R89	7030005050	S.RES ERJ2GEJ 103 X (10K)	T	79.0/25.0
R90	7030005170	S.RES ERJ2GEJ 474 X (470K)	T	95.9/15.3
R92	7030005100	S.RES ERJ2GEJ 154 X (150K)	T	94.3/14.4
R93	7030005600	S.RES ERJ2GEJ 273 X (27K)	B	81.3/25.8
R95	7030005710	S.RES ERJ2GEJ 121 X (120)	B	83.8/24.5
R96	7030008400	S.RES ERJ2GEJ 182 X (1.8K)	B	83.8/23.5
R97	7030010040	S.RES ERJ2GEJ-JPW	B	82.2/24.5
R98	7030007290	S.RES ERJ2GEJ 222 X (2.2K)	T	109.5/33.8
R100	7030005240	S.RES ERJ2GEJ 473 X (47K)	T	76.1/20.3
R101	7030004980	S.RES ERJ2GEJ 101 X (100)	T	77.9/22.2
R123	7030005530	S.RES ERJ2GEJ 100 X (10)	T	68.2/40.4
R125	7030008370	S.RES ERJ2GEJ 561 X (560)	T	65.6/29.2
R171	7030004980	S.RES ERJ2GEJ 101 X (100)	T	45.5/28.6
R172	7030008300	S.RES ERJ2GEJ 184 X (180K)	T	44.2/27.1
R173	7030005120	S.RES ERJ2GEJ 102 X (1K)	T	42.9/26.4
R174	7030005290	S.RES ERJ2GEJ 682 X (6.8K)	T	42.0/28.8
R175	7030009290	S.RES ERJ2GEJ 562 X (5.6K)	T	41.6/27.6
R176	7030005030	S.RES ERJ2GEJ 152 X (1.5K)	T	42.0/26.4
R178	7030004970	S.RES ERJ2GEJ 470 X (47)	B	39.8/24.4
R211	7030004970	S.RES ERJ2GEJ 470 X (47)	T	82.7/28.3
R212	7030010040	S.RES ERJ2GEJ-JPW	T	82.6/60.4
R234	7030005070	S.RES ERJ2GEJ 683 X (68K)	B	92.8/34.9
R235	7030004980	S.RES ERJ2GEJ 101 X (100)	B	81.0/37.9
R236	7030007570	S.RES ERJ2GEJ 122 X (1.2K)	B	67.4/22.7
R237	7030007060	S.RES ERJ2GEJ 684X (680K)	B	67.4/23.6
R289	7030005240	S.RES ERJ2GEJ 473 X (47K)	T	95.9/12.6
R290	7030005010	S.RES ERJ2GEJ 681 X (680)	T	63.2/23.1
R291	7030005090	S.RES ERJ2GEJ 104 X (100K)	T	94.3/15.9
R293	7030006610	S.RES ERJ2GEJ 394 X (390K)	T	88.4/12.0
R295	7030006610	S.RES ERJ2GEJ 394 X (390K)	T	101.0/17.3
R299	7030008300	S.RES ERJ2GEJ 184 X (180K)	B	74.6/38.5
R300	7030005720	S.RES ERJ2GEJ 563 X (56K)	B	76.8/40.6
R301	7030005100	S.RES ERJ2GEJ 154 X (150K)	B	67.5/40.5
R302	7030005720	S.RES ERJ2GEJ 563 X (56K)	B	66.9/38.3
R308	7030009140	S.RES ERJ2GEJ 272 X (2.7K)	T	56.9/54.9
R311	7030010040	S.RES ERJ2GEJ-JPW	B	94.9/32.2
R317	7030005120	S.RES ERJ2GEJ 102 X (1K)	T	105.6/37.4
R319	7030007340	S.RES ERJ2GEJ 153 X (15K)	T	37.3/37.9
R320	7030005170	S.RES ERJ2GEJ 474 X (470K)	T	35.5/36.2
R328	7030010040	S.RES ERJ2GEJ-JPW	B	104.8/29.1
R334	7030009280	S.RES ERJ2GEJ 391 X	T	87.6/61.3
R337	7030010430	S.RES ERJ2GEJ 120 X (12)	T	87.1/62.7
R338	7030009280	S.RES ERJ2GEJ 391 X	T	87.6/64.1
R339	7030010040	S.RES ERJ2GEJ-JPW	B	96.5/25.3
R340	7030005050	S.RES ERJ2GEJ 103 X (10K)	B	72.4/25.3
R350	7030005600	S.RES ERJ2GEJ 273 X (27K)	B	52.9/26.2
R351	7030005600	S.RES ERJ2GEJ 273 X (27K)	B	43.2/26.3
R352	7030007300	S.RES ERJ2GEJ 332 X (3.3K)	B	50.9/26.8
R353	7030005210	S.RES ERJ2GEJ 822 X (8.2K)	B	45.4/27.2
R354	7030005210	S.RES ERJ2GEJ 822 X (8.2K)	B	46.1

[MAIN-B UNIT] (For [High band] versions)

REF NO.	PARTS NO.	DESCRIPTION	M.	H/V LOCATION
R505	7030005290	S.RES ERJ2GEJ 682 X (6.8K)	T	76.1/22.7
R506	7030005050	S.RES ERJ2GEJ 103 X (10K)	T	74.8/21.5
R613	7030005120	S.RES ERJ2GEJ 102 X (1K)	T	81.2/39.3
R614	7030005030	S.RES ERJ2GEJ 152 X (1.5K)	T	56.2/24.3
R615	7030005040	S.RES ERJ2GEJ 472 X (4.7K)	T	50.7/27.7
R616	7030008300	S.RES ERJ2GEJ 184 X (180K)	B	59.9/19.6
R617	7030005090	S.RES ERJ2GEJ 104 X (100K)	B	57.4/15.8
R618	7030004980	S.RES ERJ2GEJ 101 X (100)	B	62.1/16.9
R619	7030005030	S.RES ERJ2GEJ 152 X (1.5K)	B	36.0/27.5
R620	7030005240	S.RES ERJ2GEJ 473 X (47K)	B	57.4/18.4
R621	7410001130	S.ARR EXB28V102JX	B	76.6/19.6
R622	7030007570	S.RES ERJ2GEJ 122 X (1.2K)	B	83.8/21.6
R623	7030005090	S.RES ERJ2GEJ 104 X (100K)	T	50.7/26.1
R624	7030005090	S.RES ERJ2GEJ 104 X (100K)	T	83.2/11.6
R625	7030010040	S.RES ERJ2GEJ-JPW	B	96.1/20.1
R1003	7030007601	S.RES ERA3YKD 913V (91K)	B	72.6/9.4
R1004	7030006101	S.RES ERA3YED 183V (18K)	B	70.2/10.2
R1005	7030005120	S.RES ERJ2GEJ 102 X (1K)	T	112.3/16.5
R1006	7030005090	S.RES ERJ2GEJ 104 X (100K)	B	112.4/8.1
R1008	7030010040	S.RES ERJ2GEJ-JPW	T	124.9/24.8
R1009	7030005050	S.RES ERJ2GEJ 103 X (10K)	T	133.3/49.2
R1010	7030005050	S.RES ERJ2GEJ 103 X (10K)	T	128.6/23.8
R1012	7030005040	S.RES ERJ2GEJ 472 X (4.7K)	T	110.6/46.0
R1013	7030005240	S.RES ERJ2GEJ 473 X (47K)	T	114.7/47.3
R1014	7030005090	S.RES ERJ2GEJ 104 X (100K)	T	98.3/12.1
R1015	7030005120	S.RES ERJ2GEJ 102 X (1K)	B	115.3/22.8
R1016	7030005090	S.RES ERJ2GEJ 104 X (100K)	B	115.6/6.1
R1018	7030005090	S.RES ERJ2GEJ 104 X (100K)	T	111.7/7.0
R1020	7030005090	S.RES ERJ2GEJ 104 X (100K)	B	114.7/24.9
R1021	7030005120	S.RES ERJ2GEJ 102 X (1K)	B	116.5/6.1
R1022	7030005120	S.RES ERJ2GEJ 102 X (1K)	T	114.9/7.1
R1023	7030005050	S.RES ERJ2GEJ 103 X (10K)	B	125.2/15.7
R1024	7030007290	S.RES ERJ2GEJ 222 X (2.2K)	B	131.6/17.6
R1025	7030000480	S.RES MCR10EZHJ 6.8K (682)	B	129.4/47.0
R1026	7030000480	S.RES MCR10EZHJ 6.8K (682)	B	129.4/48.8
R1027	7030010040	S.RES ERJ2GEJ-JPW	T	113.7/16.5
R1028	7030004970	S.RES ERJ2GEJ 470 X (47)	B	114.9/13.4
R1029	7030005120	S.RES ERJ2GEJ 102 X (1K)	T	115.3/10.5
R1030	7030005050	S.RES ERJ2GEJ 103 X (10K)	T	114.4/10.5
R1031	7030005050	S.RES ERJ2GEJ 103 X (10K)	B	117.8/7.7
R1032	7030005050	S.RES ERJ2GEJ 103 X (10K)	B	127.1/19.9
R1033	7030000480	S.RES MCR10EZHJ 6.8K (682)	B	129.4/45.2
R1034	7030005040	S.RES ERJ2GEJ 472 X (4.7K)	B	123.6/17.5
R1035	7030005050	S.RES ERJ2GEJ 103 X (10K)	T	107.8/42.5
R1036	7030005040	S.RES ERJ2GEJ 472 X (4.7K)	T	107.8/41.2
R1037	7030005090	S.RES ERJ2GEJ 104 X (100K)	T	95.9/13.5
R1038	7030005120	S.RES ERJ2GEJ 102 X (1K)	B	125.6/36.3
R1039	7030005090	S.RES ERJ2GEJ 104 X (100K)	B	113.7/12.9
R1040	7030005160	S.RES ERJ2GEJ 105 X (1M)	T	112.0/12.9
R1043	7030005160	S.RES ERJ2GEJ 105 X (1M)	B	111.2/11.0
R1044	7030005090	S.RES ERJ2GEJ 104 X (100K)	B	117.9/9.9
R1045	7030005050	S.RES ERJ2GEJ 103 X (10K)	B	120.4/17.1
R1046	7030005800	S.RES RR0510P-102-D (1K)	B	119.7/9.0
R1047	7030005050	S.RES ERJ2GEJ 103 X (10K)	B	119.4/18.6
R1048	7030009710	S.RES ERJ2GEJ 203 X (20K)	B	119.0/22.4
R1049	7030005040	S.RES ERJ2GEJ 472 X (4.7K)	B	116.7/19.7
R1050	7030007290	S.RES ERJ2GEJ 222 X (2.2K)	B	123.0/38.1
R1054	7030008270	S.RES RR0510P-104-D (100K)	B	119.7/9.9
R1055	7030005090	S.RES ERJ2GEJ 104 X (100K)	B	120.4/15.2
R1056	7030008270	S.RES RR0510P-104-D (100K)	B	118.8/10.4
R1057	7030005100	S.RES ERJ2GEJ 154 X (150K)	B	118.8/15.2
R1059	7410001130	S.ARR EXB28V102JX	T	69.7/14.8
R1060	7410001130	S.ARR EXB28V102JX	T	63.4/14.8
R1062	7030008270	S.RES RR0510P-104-D (100K)	B	116.0/14.8
R1063	7030007340	S.RES ERJ2GEJ 153 X (15K)	B	42.8/22.4
R1064	7030005090	S.RES ERJ2GEJ 104 X (100K)	T	40.5/23.1
R1068	7030005120	S.RES ERJ2GEJ 102 X (1K)	T	74.3/14.1
R1069	7030005120	S.RES ERJ2GEJ 102 X (1K)	T	72.6/14.1
R1070	7030005120	S.RES ERJ2GEJ 102 X (1K)	T	57.3/15.1
R1071	7030005090	S.RES ERJ2GEJ 104 X (100K)	T	51.7/16.7
R1072	7030005040	S.RES ERJ2GEJ 472 X (4.7K)	T	52.9/16.3
R1073	7030005700	S.RES ERJ2GEJ 274 X (270K)	B	50.8/18.7
R1074	7030005100	S.RES ERJ2GEJ 154 X (150K)	T	32.7/20.6
R1075	7030008010	S.RES ERJ2GEJ 123 X (12K)	T	36.3/21.5
R1076	7030005090	S.RES ERJ2GEJ 104 X (100K)	B	35.0/20.5
R1077	7030005170	S.RES ERJ2GEJ 474 X (470K)	B	36.6/20.2
R1078	7030005090	S.RES ERJ2GEJ 104 X (100K)	B	32.2/15.2
R1080	7030005310	S.RES ERJ2GEJ 124 X (120K)	B	40.1/13.5
R1081	7030008290	S.RES ERJ2GEJ 183 X (18K)	T	42.5/19.5
R1082	7410001130	S.ARR EXB28V102JX	T	56.9/6.7
R1083	7030005120	S.RES ERJ2GEJ 102 X (1K)	B	69.1/8.8
R1084	7410001130	S.ARR EXB28V102JX	T	61.7/6.1
R1085	7030005120	S.RES ERJ2GEJ 102 X (1K)	B	49.5/9.9
R1086	7030005100	S.RES ERJ2GEJ 154 X (150K)	B	32.2/18.5
R1087	7030007340	S.RES ERJ2GEJ 153 X (15K)	B	31.3/15.2
R1088	7030005160	S.RES ERJ2GEJ 105 X (1M)	B	31.3/16.9
R1089	7030005050	S.RES ERJ2GEJ 103 X (10K)	B	44.2/16.9
R1090	7030008300	S.RES ERJ2GEJ 184 X (180K)	B	36.5/13.4
R1092	7030008400	S.RES ERJ2GEJ 182 X (1.8K)	B	38.3/13.5
R1093	7030005090	S.RES ERJ2GEJ 104 X (100K)	B	42.9/15.5
R1094	7030005090	S.RES ERJ2GEJ 104 X (100K)	T	55.7/12.8
R1095	7030009290	S.RES ERJ2GEJ 562 X (5.6K)	T	55.7/13.7
R1096	7030005100	S.RES ERJ2GEJ 154 X (150K)	B	35.6/13.4
R1097	7030007290	S.RES ERJ2GEJ 222 X (2.2K)	T	55.2/11.6
R1098	7510001730	S.THE ERTJOEP 473J	T	74.9/15.5
R1099	7030008270	S.RES RR0510P-104-D (100K)	T	72.5/15.5
R1100	7410001130	S.ARR EXB28V102JX	T	75.3/6.0
R1101	7030005290	S.RES ERJ2GEJ 682 X (6.8K)	B	44.0/20.2
R1102	7030005040	S.RES ERJ2GEJ 472 X (4.7K)	B	42.4/16.4
R1103	7030005290	S.RES ERJ2GEJ 682 X (6.8K)	B	52.9/18.3
R1105	7030003860	S.RES ERJ3GE JPW V	T	127.8/48.9
R1106	7030009290	S.RES ERJ2GEJ 562 X (5.6K)	B	41.0/20.8
R1107	7030008410	S.RES ERJ2GEJ 392 X (3.9K)	B	39.2/20.0
R1108	7030005240	S.RES ERJ2GEJ 473 X (47K)	B	124.9/41.7
R1111	7030005060	S.RES ERJ2GEJ 333 X (33K)	T	36.3/19.7

[MAIN-B UNIT] (For [High band] versions)

REF NO.	PARTS NO.	DESCRIPTION	M.	H/V LOCATION
R1112	7030005230	S.RES ERJ2GEJ 334 X (330K)	B	41.5/19.6
R1113	7030005720	S.RES ERJ2GEJ 563 X (56K)	B	44.0/21.3
R1114	7030005120	S.RES ERJ2GEJ 102 X (1K)	T	65.8/6.4
R1115	7030005120	S.RES ERJ2GEJ 102 X (1K)	T	65.8/5.4
R1116	7030007300	S.RES ERJ2GEJ 332 X (3.3K)	T	73.7/15.0
R1117	7030005090	S.RES ERJ2GEJ 104 X (100K)	T	42.4/18.2
R1119	7030003860	S.RES ERJ3GE JPW V	B	99.5/68.6
		[USA-02] [EXP-04]		
R2003	7030007250	S.RES ERJ2GEJ 220 X (22)	B	16.7/6.8
R2004	7030005210	S.RES ERJ2GEJ 822 X (8.2K)	B	12.6/8.8
R2005	7030005210	S.RES ERJ2GEJ 822 X (8.2K)	B	15.8/6.8
R2009	7030007290	S.RES ERJ2GEJ 222 X (2.2K)	B	10.5/11.7
R2010	7030004980	S.RES ERJ2GEJ 101 X (100)	T	11.5/11.7
R2011	7030004980	S.RES ERJ2GEJ 101 X (100)	T	23.0/10.4
R2012	7030004980	S.RES ERJ2GEJ 101 X (100)	T	22.5/11.3
R2013	7030005240	S.RES ERJ2GEJ 473 X (47K)	B	19.8/12.0
R2015	7030005240	S.RES ERJ2GEJ 473 X (47K)	T	18.4/11.6
R2016	7030010040	S.RES ERJ2GEJ-JPW	B	24.0/5.8
R2019	7030010040	S.RES ERJ2GEJ-JPW	B	9.9/17.9
R2020	7030010040	S.RES ERJ2GEJ-JPW	B	14.4/11.1
R2021	7030004980	S.RES ERJ2GEJ 101 X (100)	B	23.6/12.1
R2022	7030004980	S.RES ERJ2GEJ 101 X (100)	B	27.9/24.7
R2024	7030005240	S.RES ERJ2GEJ 473 X (47K)	B	26.6/21.6
R2026	7030004970	S.RES ERJ2GEJ 470 X (47)	B	27.9/22.9
R2028	7030005240	S.RES ERJ2GEJ 473 X (47K)	B	12.1/19.3
R2030	7030005240	S.RES ERJ2GEJ 473 X (47K)	B	11.0/21.2
R2031	7030005240	S.RES ERJ2GEJ 473 X (47K)	B	10.7/29.4
R2032	7030005240	S.RES ERJ2GEJ 473 X (47K)	B	24.9/17.4
R2034	7030005240	S.RES ERJ2GEJ 473 X (47K)	B	28.8/10.5
R2035	7030005240	S.RES ERJ2GEJ 473 X (47K)	B	26.7/14.9
R2036	7030004980	S.RES ERJ2GEJ 101 X (100)	T	26.8/11.9
R2037	7030007290	S.RES ERJ2GEJ 222 X (2.2K)	T	28.1/10.7
R2038	7030004970	S.RES ERJ2GEJ 470 X (47)	B	28.8/12.1
R2039	7030005240	S.RES ERJ2GEJ 473 X (47K)	B	24.1/9.5
R2040	7030005240	S.RES ERJ2GEJ 473 X (47K)	B	24.5/12.1
R2043	7410001140	S.ARR EXB28V104JX	T	15.6/26.7
R2044	7410001140	S.ARR EXB28V104JX	B	20.8/26.3
R2045	7410001140	S.ARR EXB28V104JX	T	27.0/22.6
R2046	7410001140	S.ARR EXB28V104JX	B	19.3/26.7
R2047	7410001140	S.ARR EXB28V104JX	T	10.9/14.5
R2048	7030005090	S.RES ERJ2GEJ 104 X (100K)	T	25.7/14.6
R2049	7030005090	S.RES ERJ2GEJ 104 X (100K)	B	21.8/15.6
R2050	7410001140	S.ARR EXB28V104JX	B	22.6/18.2
R2051	7410001140	S.ARR EXB28V104JX	T	9.9/17.6
R2052	7030005090	S.RES ERJ2GEJ 104 X (100K)	T	16.8/11.6
R2053	7030005090	S.RES ERJ2GEJ 104 X (100K)	B	16.0/14.5
R2056	7030010040	S.RES ERJ2GEJ-JPW	T	10.6/20.0
R2057	7030005090	S.RES ERJ2GEJ 104 X (100K)	T	10.4/22.9
R2058	7410001140	S.ARR EXB28V104JX	B	17.0/18.6
R2059	7030005090	S.RES ERJ2GEJ 104 X (100K)	T	10.4/23.8
R2060	7030005090	S.RES ERJ2GEJ 104 X (100K)	T	25.7/15.6
R2061	7030005090	S.RES ERJ2GEJ 104 X (100K)	B	14.7/12.6
R2062	7030005090	S.RES ERJ2GEJ 104 X (100K)	B	17.7/14.4
R2063	7030005090	S.RES ERJ2GEJ 104 X (100K)	B	22.1/23.4
R2064	7030005090	S.RES ERJ2GEJ 104 X (100K)	B	19.7/17.7
R2065	7030005030	S.RES ERJ2GEJ 152 X (1.5K)	B	13.8/6.8
R2066	7410001170	S.ARR EXB28V470JX	T	21.3/6.7
R2067	7030010040	S.RES ERJ2GEJ-JPW	T	11.4/5.3
R2068	7030010040	S.RES ERJ2GEJ-JPW	T	20.9/10.7
R2071	7030010040	S.RES ERJ2GEJ-JPW	T	24.9/5.4
R2072	7030005050	S.RES ERJ2GEJ 103 X (10K)	B	12.2/10.1
R2074	7030010040	S.RES ERJ2GEJ-JPW	T	8.7/10.0
R2084	7030010040	S.RES ERJ2GEJ-JPW	T	30.7/10.5
R2085	7030010040	S.RES ERJ2GEJ-JPW	B	19.5/9.6
C1	4030011050	S.CER GRM31M3C2H3R0CY21L (GRM42-6 CJ)	B	8.4/66.6
C2	4030011070	S.CER GRM31M2C2H5R0CY21L (GRM42-6 CH)	B	7.4/58.6
C3	4030009500	S.CER C1608 CH 1H 0R5B-T	B	25.6/51.9
C4	4030009500	S.CER C1608 CH 1H 0R5B-T	B	16.4/51.9
C5	4030009500	S.CER C1608 CH 1H 0R5B-T	B	8.2/54.5
C6	4030011060	S.CER GRM31M2C2H4R0CY21L (GRM42-6 CH)	B	7.4/56.3
C7	4030011070	S.CER GRM31M2C2H5R0CY21L (GRM42-6 CH)	B	13.1/60.7
C8	4030011050	S.CER GRM31M3C2H3R0CY21L (GRM42-6 CJ)	B	19.5/60.7
C9	4030011050	S.CER GRM31M3C2H3R0CY21L (GRM42-6 CJ)	T	30.6/53.1
C10	4030017730	S.CER C1005 JB 1H 471K-T	B	1

[MAIN-B UNIT] (For [High band] versions)

REF NO.	PARTS NO.	DESCRIPTION	M.	H/V LOCATION
C41	4030017400	S.CER C1005 CH 1H 220J-T	B	66.9/39.2
C42	4030017460	S.CER C1005 JB 1H 102K-T	T	54.0/37.8
C43	4030016930	S.CER C1005 JB 1A 104K-T	B	54.1/38.3
C44	4030017560	S.CER C1005 CH 1H 2R5B-T	B	59.9/40.5
C45	4030017620	S.CER C1005 CH 1H 100C-T	B	55.5/42.0
C48	4030017420	S.CER C1005 CH 1H 470J-T	B	72.2/40.6
C49	4030017380	S.CER C1005 CH 1H 050B-T	B	75.9/39.2
C50	4030017460	S.CER C1005 JB 1H 102K-T	B	73.1/40.6
C51	4030017460	S.CER C1005 JB 1H 102K-T	T	72.4/41.1
C52	4030017620	S.CER C1005 CH 1H 100C-T	B	70.4/41.2
C53	4030016790	S.CER C1005 JB 1E 103K-T	B	71.3/42.8
C54	4030017730	S.CER C1005 JB 1H 471K-T	B	70.4/42.8
C57	4030017460	S.CER C1005 JB 1H 102K-T	B	74.6/36.7
C58	4030017460	S.CER C1005 JB 1H 102K-T	T	67.2/26.1
C59	4030017460	S.CER C1005 JB 1H 102K-T	T	66.9/22.7
C60	4030016790	S.CER C1005 JB 1E 103K-T	T	65.3/26.6
C61	4030017430	S.CER C1005 CH 1H 101J-T	T	61.6/23.1
C62	4030017420	S.CER C1005 CH 1H 470J-T	B	57.1/24.3
C63	4030017420	S.CER C1005 CH 1H 470J-T	T	60.3/14.3
C64	4030016790	S.CER C1005 JB 1E 103K-T	B	56.2/26.8
C65	4030018860	S.CER C1005 JB 0J 105K-T	T	58.2/19.6
C66	4030017460	S.CER C1005 JB 1H 102K-T	T	54.7/19.9
C67	4030017460	S.CER C1005 JB 1H 102K-T	B	58.4/21.3
C68	4030017680	S.CER C1005 CH 1H 820J-T	T	52.2/23.8
C69	4030017710	S.CER C1005 CH 1H 181J-T	T	54.0/23.8
C70	4030017710	S.CER C1005 CH 1H 181J-T	T	54.0/25.6
C71	4030016930	S.CER C1005 JB 1A 104K-T	T	57.4/29.0
C72	4030017730	S.CER C1005 JB 1H 471K-T	T	59.8/48.0
	4030017730	S.CER C1005 JB 1H 471K-T	[USA-02] [EXP-04]	
C74	4030017730	S.CER C1005 JB 1H 471K-T	B	11.2/50.5
C75	4030019560	S.CER GRM21BB31C106KE15L	T	61.6/25.3
C76	4030016790	S.CER C1005 JB 1E 103K-T	T	57.8/54.9
C77	4030017460	S.CER C1005 JB 1H 102K-T	T	56.8/50.7
C78	4030017730	S.CER C1005 JB 1H 471K-T	B	58.8/56.6
C79	4030016960	S.CER C1005 JB 1E 183K-T	T	62.4/55.0
C81	4030017460	S.CER C1005 JB 1H 102K-T	T	65.1/55.0
C82	4030011050	S.CER GRM31M3C2H3R0CY21L (GRM42-6 CJ)	T	34.9/65.2
C84	4030017420	S.CER C1005 CH 1H 470J-T	T	55.0/61.6
C85	4030017460	S.CER C1005 JB 1H 102K-T	T	56.0/61.6
C86	4030017710	S.CER C1005 CH 1H 181J-T	T	81.3/63.8
C87	4030017460	S.CER C1005 JB 1H 102K-T	T	79.8/68.8
C88	4030017730	S.CER C1005 JB 1H 471K-T	T	64.6/52.1
C89	4030017590	S.CER C1005 CH 1H 070C-T	B	87.3/57.5
C90	4030017590	S.CER C1005 CH 1H 070C-T	B	88.2/57.5
C92	4030017570	S.CER C1005 CH 1H 040B-T	B	89.9/58.0
C93	4030017590	S.CER C1005 CH 1H 070C-T	B	86.9/51.5
C96	4030017460	S.CER C1005 JB 1H 102K-T	B	87.8/56.3
C97	4030017730	S.CER C1005 JB 1H 471K-T	B	87.8/55.4
C98	4030017390	S.CER C1005 CH 1H 180J-T	B	83.5/48.7
C99	4030017730	S.CER C1005 JB 1H 471K-T	B	81.4/48.3
C100	4030017590	S.CER C1005 CH 1H 070C-T	B	91.2/34.9
C102	4030017590	S.CER C1005 CH 1H 070C-T	B	97.1/33.8
C103	4030017360	S.CER C1005 CH 1H 030B-T	B	98.5/32.2
C104	4030017460	S.CER C1005 JB 1H 102K-T	B	100.8/29.9
C105	4030017730	S.CER C1005 JB 1H 471K-T	B	97.6/28.9
C106	4030017420	S.CER C1005 CH 1H 470J-T	B	91.7/48.9
C107	4030017460	S.CER C1005 JB 1H 102K-T	T	80.2/51.7
C108	4030016790	S.CER C1005 JB 1E 103K-T	B	81.3/49.2
C109	4030017460	S.CER C1005 JB 1H 102K-T	B	95.8/35.3
C110	4030017730	S.CER C1005 JB 1H 471K-T	B	98.6/35.3
C111	4030017730	S.CER C1005 JB 1H 471K-T	T	101.7/37.1
C112	4030016930	S.CER C1005 JB 1A 104K-T	T	100.8/37.1
C113	4030017540	S.CER C1005 CH 1H R75B-T	[EXP-02] [USA-02] [EXP-04]	B 102.0/29.6
	4030017520	S.CER C1005 CH 1H 0R3B-T	[USA-02] [EXP-04]	
	4030017520	S.CER C1005 CH 1H 0R3B-T	[USA-02] [EXP-04]	
C114	4030017600	S.CER C1005 CH 1H 080C-T	B	98.3/26.1
C115	4030017620	S.CER C1005 CH 1H 100C-T	B	98.8/21.9
C116	4030017460	S.CER C1005 JB 1H 102K-T	B	107.5/30.0
C117	4030017730	S.CER C1005 JB 1H 471K-T	B	107.5/30.9
C118	4030017520	S.CER C1005 CH 1H 0R3B-T	B	102.8/32.0
C119	4030016790	S.CER C1005 JB 1E 103K-T	B	97.0/21.9
C120	4030017730	S.CER C1005 JB 1H 471K-T	B	97.9/21.9
C121	4030017590	S.CER C1005 CH 1H 070C-T	B	103.3/30.8
C122	4030017620	S.CER C1005 CH 1H 100C-T	B	107.5/31.8
C123	4030017600	S.CER C1005 CH 1H 080C-T	B	104.8/28.2
C124	4030017640	S.CER C1005 CH 1H 150J-T	B	105.0/20.8
C125	4030017420	S.CER C1005 CH 1H 470J-T	B	101.7/27.5
C126	4030017380	S.CER C1005 CH 1H 050B-T	B	95.6/23.7
C127	4030017640	S.CER C1005 CH 1H 150J-T	B	96.1/21.9
C128	4030017360	S.CER C1005 CH 1H 030B-T	B	99.2/27.3
C129	4030017520	S.CER C1005 CH 1H 0R3B-T	B	103.5/27.5
C131	4030017540	S.CER C1005 CH 1H R75B-T	B	106.4/27.2
C132	4030017460	S.CER C1005 JB 1H 102K-T	T	94.3/12.6
C133	4030017610	S.CER C1005 CH 1H 090C-T	B	105.4/22.7
C134	4030017600	S.CER C1005 CH 1H 080C-T	B	93.7/22.8
C135	4030016790	S.CER C1005 JB 1E 103K-T	T	78.3/21.0
C139	4030016930	S.CER C1005 JB 1A 104K-T	B	107.5/33.6
C140	4030017430	S.CER C1005 CH 1H 101J-T	B	81.2/18.9
C141	4030017460	S.CER C1005 JB 1H 102K-T	T	75.7/21.5
C143	4030017460	S.CER C1005 JB 1H 102K-T	T	78.9/22.2
C144	4030017420	S.CER C1005 CH 1H 470J-T	T	92.5/16.1
C146	4550000520	S.TAN TEESVA 1V 683M8R	T	84.7/22.9
C147	4550003250	S.TAN TEESVA 1V 474M8R	T	80.5/22.9
C148	4030019560	S.CER GRM21BB31C106KE15L	T	109.7/30.5
C151	4030016930	S.CER C1005 JB 1A 104K-T	B	75.3/18.1
C152	4030017420	S.CER C1005 CH 1H 470J-T	B	77.8/18.1
C153	4030017420	S.CER C1005 CH 1H 470J-T	B	78.1/16.2
C154	4030017420	S.CER C1005 CH 1H 470J-T	B	76.4/16.2
C155	4030017460	S.CER C1005 JB 1H 102K-T	B	81.7/16.7
C156	4030016790	S.CER C1005 JB 1E 103K-T	B	81.2/17.9
C157	4030017620	S.CER C1005 CH 1H 100C-T	B	74.2/24.4
C160	4030016930	S.CER C1005 JB 1A 104K-T	B	72.4/21.3
C162	4030016790	S.CER C1005 JB 1E 103K-T	B	72.4/17.7
C165	4030017460	S.CER C1005 JB 1H 102K-T	B	74.1/23.5

[MAIN-B UNIT] (For [High band] versions)

REF NO.	PARTS NO.	DESCRIPTION	M.	H/V LOCATION
C192	4030017350	S.CER C1005 CH 1H 020B-T	B	34.3/40.5
C193	4030017530	S.CER C1005 CH 1H 0R5B-T	B	51.5/38.3
C277	4030016930	S.CER C1005 JB 1A 104K-T	B	36.0/28.4
C281	4030017770	S.CER C1005 JB 1H 332K-T	T	92.0/13.5
C282	4030016930	S.CER C1005 JB 1A 104K-T	T	44.2/28.0
C283	4030016930	S.CER C1005 JB 1A 104K-T	T	42.5/25.2
C284	4030016930	S.CER C1005 JB 1A 104K-T	T	44.2/28.9
C285	4030017570	S.CER C1005 CH 1H 040B-T	B	94.0/29.9
C286	4030017600	S.CER C1005 CH 1H 080C-T	B	36.4/26.3
C287	4030017460	S.CER C1005 JB 1H 102K-T	T	95.9/11.7
C298	4030017370	S.CER C1005 CH 1H 3R5B-T	T	86.3/29.4
C299	4030017370	S.CER C1005 CH 1H 3R5B-T	T	83.9/29.4
C300	4030017350	S.CER C1005 CH 1H 020B-T	B	85.1/30.8
C301	4030017730	S.CER C1005 JB 1H 471K-T	T	92.8/31.3
C302	4030017420	S.CER C1005 CH 1H 470J-T	B	80.1/39.2
C303	4030017730	S.CER C1005 JB 1H 471K-T	B	80.1/36.3
C305	4030017500	S.CER C1005 CH 1H 560J-T	B	64.8/24.2
C306	4030017580	S.CER C1005 CH 1H 060C-T	B	64.3/25.4
C307	4030017500	S.CER C1005 CH 1H 560J-T	B	61.3/22.7
C308	4030017360	S.CER C1005 CH 1H 030B-T	B	60.1/23.2
C309	4030016790	S.CER C1005 JB 1E 103K-T	B	67.4/21.8
C312	4030016930	S.CER C1005 JB 1A 104K-T	B	67.4/20.9
C314	4030016790	S.CER C1005 JB 1E 103K-T	T	110.5/33.8
C323	4030017620	S.CER C1005 CH 1H 100C-T	B	72.3/26.2
C332	4030017530	S.CER C1005 CH 1H 0R5B-T	B	84.9/50.0
C333	4030017420	S.CER C1005 CH 1H 470J-T	B	40.4/40.7
C334	4030017590	S.CER C1005 CH 1H 070C-T	B	94.9/68.3
C335	4030017630	S.CER C1005 CH 1H 120J-T	B	93.8/68.3
C336	4030017710	S.CER C1005 CH 1H 181J-T	B	62.0/68.7
C337	4030017460	S.CER C1005 JB 1H 102K-T	T	82.7/29.2
C340	4030017710	S.CER C1005 CH 1H 181J-T	B	107.7/28.7
C342	4550002980	S.TAN TEESVA 1C 225M8R	T	78.4/66.1
C343	4030017460	S.CER C1005 JB 1H 102K-T	B	51.5/39.2
C344	4030017460	S.CER C1005 JB 1H 102K-T	B	54.2/68.0
C345	4030017730	S.CER C1005 JB 1H 471K-T	B	54.2/67.1
C346	4030017420	S.CER C1005 CH 1H 470J-T	B	66.0/68.4
C347	4030017460	S.CER C1005 JB 1H 102K-T	T	52.2/22.9
C348	4030017460	S.CER C1005 JB 1H 102K-T	T	59.3/20.5
C350	4030017920	S.CER C1005 JB 1A 683K-T	T	95.9/14.4
C357	4030016930	S.CER C1005 JB 1A 104K-T	T	103.5/34.7
C358	4030017340	S.CER C1005 CH 1H 010B-T	B	91.2/35.8
C366	4030017460	S.CER C1005 JB 1H 102K-T	B	97.0/64.4
C367	4030017730	S.CER C1005 JB 1H 471K-T	B	97.0/65.8
C368	4030017420	S.CER C1005 CH 1H 470J-T	B	97.0/67.3
C372	4030017730	S.CER C1005 JB 1H 471K-T	T	60.3/67.7
C376	4030017730	S.CER C1005 JB 1H 471K-T	B	88.7/49.5
C377	4030017460	S.CER C1005 JB 1H 102K-T	T	57.8/61.6
C383	4030018860	S.CER C1005 JB 0J 105K-T	T	36.4/36.2
C384	4030016930	S.CER C1005 JB 1A 104K-T	T	59.3/29.0
C385	4030016930	S.CER C1005 JB 1A 104K-T	B	54.9/28.9
C388	4030017730	S.CER C1005 JB 1H 471K-T	B	68.2/36.7
C390	4030017460	S.CER C1005 JB 1H 102K-T	B	75.0/40.6
C391	4030017420	S.CER C1005 CH 1H 470J-T	B	75.9/40.6
C392	4030017520	S.CER C1005 CH 1H 0R3B-T	B	60.3/39.2
C393	4030017500	S.CER C1005 CH 1H 1R5B-T	B	66.3/40.5
C394	4030016930	S.CER C1005 JB 1A 104K-T	B	50.9/28.8
C395	4030016930	S.CER C1005 JB 1A 104K-T	B	45.1/29.0
C396	4030016930	S.CER C1005 JB 1A 104K-T	T	55.8/29.0
C397	4030016790	S.CER C1005 JB 1E 103K-T	B	50.4/12.7
C398	4030016790	S.CER C1005 JB 1E 103K-T	B	48.6/27.3
C399	4030016790	S.CER C1005 JB 1E 103K-T	B	48.3/28.5
C400	4030017710	S.CER C1005 CH 1H 181J-T	T	81.2/37.6
C401	4030017580	S.CER C1005 CH 1H 060C-T	B	78.6/40.6
C402	4030011040	S.CER GRM31M4C2H2R0CY21L (GRM42-6 CK)	B	38.0/68.7
C404	4030011060	S.CER GRM31M2C2H4R0CY21L (GRM42-6 CH)	B	15.5/60.7
C408	4030017730	S.CER C1005 JB 1H 471K-T	B	23.9/48.1
C409	4030017460	S.CER C1005 JB 1H 102K-T	B	39.3/51.1
C411	4030017460	S.CER C1005 JB 1H 102K-T	[USA-02] [EXP-04]	T 42.2/55.4
	4030017460	S.CER C1005 JB 1H 102K-T	[USA-02] [EXP-04]	
C413	4030018860	S.CER C1005 JB 0J 105K-T	B	91.5/25.3
C416	4030017420	S.CER		

[MAIN-B UNIT] (For [High band] versions)

REF NO.	PARTS NO.	DESCRIPTION	M.	H/V LOCATION
C639	4030016930	S.CER C1005 JB 1A 104K-T	T	46.8/25.7
C640	4030017040	S.CER C1005 JB 1A 333K-T	B	38.8/24.4
C641	4030018890	S.CER C1005 JB 0J 224K-T	B	76.3/27.1
C642	4030018890	S.CER C1005 JB 0J 224K-T	B	77.5/27.0
C643	4030017430	S.CER C1005 CH 1H 101J-T	B	77.5/27.9
C644	4030019560	S.CER GRM21BB31C106KE15L	B	81.7/20.4
C645	4030016930	S.CER C1005 JB 1A 104K-T	B	30.0/15.7
C646	4030017460	S.CER C1005 JB 1H 102K-T	T	84.7/10.0
C647	4030016790	S.CER C1005 JB 1E 103K-T	B	59.1/27.7
C1003	4030017460	S.CER C1005 JB 1H 102K-T	T	133.3/63.5
C1005	4030018980	S.CER C1608 JB 1H 104K-T	B	100.1/11.8
C1007	4030017460	S.CER C1005 JB 1H 102K-T	T	100.1/12.1
C1008	4510009680	S.ELE EEEFK1E471P	B	110.2/52.6
C1010	4030017460	S.CER C1005 JB 1H 102K-T	B	106.5/59.0
C1011	4030016930	S.CER C1005 JB 1A 104K-T	B	93.9/12.1
C1012	4030017420	S.CER C1005 CH 1H 470J-T	B	117.5/16.6
C1014	4030017460	S.CER C1005 JB 1H 102K-T	T	116.6/27.5
C1015	4030017460	S.CER C1005 JB 1H 102K-T	T	114.9/8.0
C1017	4030017460	S.CER C1005 JB 1H 102K-T	B	122.5/64.9
C1018	4030017460	S.CER C1005 JB 1H 102K-T	T	133.3/45.0
C1019	4510009250	S.ELE EEEFK1C471P	B	130.5/34.8
C1022	4030017420	S.CER C1005 CH 1H 470J-T	B	105.5/59.0
C1023	4030017460	S.CER C1005 JB 1H 102K-T	B	113.4/58.8
C1024	4030017440	S.CER C1005 CH 1H 221J-T	B	113.4/59.7
C1025	4030017510	S.CER C1005 CH 1H 680J-T	B	113.4/60.6
C1026	4030019120	S.CER GRM188B31E105KA75D	T	115.8/49.5
C1028	4030017460	S.CER C1005 JB 1H 102K-T	B	117.4/6.1
C1029	4030017460	S.CER C1005 JB 1H 102K-T	T	114.9/12.6
C1031	4030017460	S.CER C1005 JB 1H 102K-T	T	115.0/16.9
C1032	4030016930	S.CER C1005 JB 1A 104K-T	B	123.6/16.6
C1033	4510009680	S.ELE EEEFK1E471P	B	120.0/29.1
C1034	4030018860	S.CER C1005 JB 0J 105K-T	B	131.6/16.6
C1035	4030016790	S.CER C1005 JB 1E 103K-T	B	131.6/18.7
C1036	4030018980	S.CER C1608 JB 1H 104K-T	T	128.4/46.9
C1037	4030019560	S.CER GRM21BB31C106KE15L	B	129.4/43.4
C1038	4030011600	S.CER C1608 JB 1E 104K-T	T	110.5/48.7
C1039	4510009680	S.ELE EEEFK1E471P	B	117.0/41.7
C1040	4030019560	S.CER GRM21BB31C106KE15L	B	116.7/22.2
C1042	4030016930	S.CER C1005 JB 1A 104K-T	B	118.1/22.4
C1043	4030016930	S.CER C1005 JB 1A 104K-T	T	114.9/16.0
C1045	4030017460	S.CER C1005 JB 1H 102K-T	T	114.9/14.2
C1046	4030018860	S.CER C1005 JB 0J 105K-T	T	114.9/15.1
C1048	4030018900	S.CER C1005 JB 0J 474K-T	B	126.7/18.6
C1050	4030018860	S.CER C1005 JB 0J 105K-T	B	125.2/16.6
C1051	4030017460	S.CER C1005 JB 1H 102K-T	B	122.1/48.2
C1052	4030016930	S.CER C1005 JB 1A 104K-T	T	127.8/40.1
C1053	4030019560	S.CER GRM21BB31C106KE15L	T	127.8/44.5
C1056	4030018860	S.CER C1005 JB 0J 105K-T	T	111.2/11.7
C1057	4030016930	S.CER C1005 JB 1A 104K-T	B	118.7/17.1
C1058	4030019560	S.CER GRM21BB31C106KE15L	T	105.5/44.4
C1059	4030017460	S.CER C1005 JB 1H 102K-T	T	107.7/46.3
C1060	4030017460	S.CER C1005 JB 1H 102K-T	B	126.2/39.8
C1061	4030017460	S.CER C1005 JB 1H 102K-T	T	107.7/37.4
C1062	4030017460	S.CER C1005 JB 1H 102K-T	B	120.7/22.9
C1063	4030019560	S.CER GRM21BB31C106KE15L	B	126.9/22.2
C1064	4030019560	S.CER GRM21BB31C106KE15L	B	121.6/36.0
C1065	4030017460	S.CER C1005 JB 1H 102K-T	B	120.2/35.6
C1066	4030018860	S.CER C1005 JB 0J 105K-T	B	125.6/38.1
C1070	4030017440	S.CER C1005 CH 1H 221J-T	B	120.4/16.2
C1071	4030016930	S.CER C1005 JB 1A 104K-T	B	120.4/10.8
C1074	4030017460	S.CER C1005 JB 1H 102K-T	B	73.9/10.4
C1075	4030017460	S.CER C1005 JB 1H 102K-T	B	70.7/14.4
C1076	4030017460	S.CER C1005 JB 1H 102K-T	B	69.7/14.4
C1077	4030017460	S.CER C1005 JB 1H 102K-T	B	68.8/14.4
C1080	4030016790	S.CER C1005 JB 1E 103K-T	B	51.1/15.3
C1081	4030016930	S.CER C1005 JB 1A 104K-T	B	117.2/15.2
C1082	4030016930	S.CER C1005 JB 1A 104K-T	B	114.8/14.6
C1083	4030017460	S.CER C1005 JB 1H 102K-T	T	37.6/19.3
C1084	4030017710	S.CER C1005 CH 1H 181J-T	B	41.9/20.8
C1092	4030016930	S.CER C1005 JB 1A 104K-T	B	75.8/14.4
C1095	4030016930	S.CER C1005 JB 1A 104K-T	T	38.5/19.3
C1096	4030018860	S.CER C1005 JB 0J 105K-T	T	51.7/18.5
C1097	4030018240	S.CER C1005 JB 1H 562K-T	B	50.8/17.8
C1098	4030018860	S.CER C1005 JB 0J 105K-T	T	54.5/16.3
C1099	4030018860	S.CER C1005 JB 0J 105K-T	B	45.2/20.8
C1100	4030017460	S.CER C1005 JB 1H 102K-T	B	75.8/9.1
C1101	4030016930	S.CER C1005 JB 1A 104K-T	T	78.2/8.0
C1102	4030017420	S.CER C1005 CH 1H 470J-T	B	71.6/6.6
C1106	4030016930	S.CER C1005 JB 1A 104K-T	T	36.3/20.6
C1107	4030017440	S.CER C1005 CH 1H 221J-T	B	33.1/15.2
C1108	4030017450	S.CER C1005 JB 1H 271K-T	B	39.2/13.5
C1109	4030018860	S.CER C1005 JB 0J 105K-T	T	42.5/18.0
C1110	4030018860	S.CER C1005 JB 0J 105K-T	T	42.5/20.4
C1111	4030018860	S.CER C1005 JB 0J 105K-T	B	46.6/19.1
C1112	4030016930	S.CER C1005 JB 1A 104K-T	B	45.7/19.1
C1119	4030017420	S.CER C1005 CH 1H 470J-T	B	65.2/6.9
C1127	4030017660	S.CER C1005 CH 1H 330J-T	B	36.6/21.2
C1128	4030016930	S.CER C1005 JB 1A 104K-T	B	31.3/13.6
C1129	4030016930	S.CER C1005 JB 1A 104K-T	B	32.2/16.9
C1130	4030017900	S.CER C1005 JB 1E 123K-T	B	37.4/13.5
C1131	4550006970	S.TAN TEESVA0G476M8R	T	53.5/12.1
C1132	4030017460	S.CER C1005 JB 1H 102K-T	T	51.8/13.0
C1133	4030016790	S.CER C1005 JB 1E 103K-T	T	78.2/5.7
C1135	4030017460	S.CER C1005 JB 1H 102K-T	T	73.9/16.8
C1136	4030016930	S.CER C1005 JB 1A 104K-T	T	71.6/15.5
C1137	4030016970	S.CER C1005 JB 1E 223K-T	B	40.1/20.8
C1138	4030017460	S.CER C1005 JB 1H 102K-T	T	37.7/15.7
C1139	4030017920	S.CER C1005 JB 1A 683K-T	T	54.5/17.2
C1140	4030017040	S.CER C1005 JB 1A 333K-T	B	52.0/18.3
C1141	4030016790	S.CER C1005 JB 1E 103K-T	B	42.4/17.3
C1142	4030016930	S.CER C1005 JB 1A 104K-T	B	117.6/11.8
C1143	4030018980	S.CER C1608 JB 1H 104K-T	B	93.8/9.4
C1144	4030016930	S.CER C1005 JB 1A 104K-T	B	41.7/15.1
C1145	4030018090	S.CER C1005 JB 1E 822K-T	B	42.8/20.8
C2001	4050000240	S.FEE NFM18PC104R1C3D	T	39.3/10.9

[MAIN-B UNIT] (For [High band] versions)

REF NO.	PARTS NO.	DESCRIPTION	M.	H/V LOCATION
C2002	4030016930	S.CER C1005 JB 1A 104K-T	B	34.9/5.4
C2004	4550007730	S.TAN TEESVJ 0J 106M8R	B	35.3/7.2
C2007	4030018910	S.CER C1608 JB 0J 475K-T	B	18.4/10.4
C2008	4030016930	S.CER C1005 JB 1A 104K-T	B	16.1/8.9
C2009	4050000240	S.FEE NFM18PC104R1C3D	B	28.0/5.9
C2010	4050000240	S.FEE NFM18PC104R1C3D	B	12.3/5.5
C2011	4030019460	S.CER C1608 JB 0J 106M-T	T	33.0/6.9
C2012	4030016930	S.CER C1005 JB 1A 104K-T	B	26.4/5.8
C2013	4550007730	S.TAN TEESVJ 0J 106M8R	B	25.0/6.2
C2014	4030016930	S.CER C1005 JB 1A 104K-T	T	31.7/6.6
C2015	4030016930	S.CER C1005 JB 1A 104K-T	B	10.1/6.4
C2016	4550007720	S.TAN TEESVJ 0G 476M8R	T	26.7/7.1
C2017	4550007730	S.TAN TEESVJ 0J 106M8R	B	17.2/9.2
C2018	4030016930	S.CER C1005 JB 1A 104K-T	B	9.2/6.4
C2019	4030016790	S.CER C1005 JB 1E 103K-T	B	14.8/19.3
C2021	4030018910	S.CER C1608 JB 0J 475K-T	B	16.0/21.6
C2022	4030018910	S.CER C1608 JB 0J 475K-T	B	13.5/14.5
C2023	4030016790	S.CER C1005 JB 1E 103K-T	B	23.1/14.3
C2024	4030018860	S.CER C1005 JB 0J 105K-T	B	21.2/14.1
C2025	4030017420	S.CER C1005 CH 1H 470J-T	B	20.8/11.1
C2026	4030017460	S.CER C1005 JB 1H 102K-T	B	20.8/10.2
C2027	4030018910	S.CER C1608 JB 0J 475K-T	B	10.9/10.0
C2028	4030018860	S.CER C1005 JB 0J 105K-T	T	11.5/10.2
C2031	4030018860	S.CER C1005 JB 0J 105K-T	T	20.9/11.3
C2032	4030016930	S.CER C1005 JB 1A 104K-T	T	13.1/11.7
C2033	4030018860	S.CER C1005 JB 0J 105K-T	B	15.1/17.7
C2034	4030016930	S.CER C1005 JB 1A 104K-T	T	11.9/7.9
C2035	4030018910	S.CER C1608 JB 0J 475K-T	T	10.2/8.2
C2036	4030018860	S.CER C1005 JB 0J 105K-T	B	21.1/20.9
C2038	4030016790	S.CER C1005 JB 1E 103K-T	B	16.4/25.3
C2039	4030017430	S.CER C1005 CH 1H 101J-T	B	19.7/7.5
C2040	4030016790	S.CER C1005 JB 1E 103K-T	T	26.4/18.1
C2041	4030018910	S.CER C1608 JB 0J 475K-T	T	11.1/14.5
C2042	4030016930	S.CER C1005 JB 1A 104K-T	T	10.1/14.8
C2044	4030016790	S.CER C1005 JB 1E 103K-T	B	26.4/19.9
C2045	4030016930	S.CER C1005 JB 1A 104K-T	T	26.6/23.4
C2046	4030016930	S.CER C1005 JB 1A 104K-T	B	26.6/24.3
C2047	4030016930	S.CER C1005 JB 1A 104K-T	B	26.6/20.7
C2048	4030016930	S.CER C1005 JB 1A 104K-T	B	26.6/22.5
C2049	4030017420	S.CER C1005 CH 1H 470J-T	B	25.7/9.5
C2050	4030017620	S.CER C1005 CH 1H 100C-T	B	26.7/15.8
C2051	4030016930	S.CER C1005 JB 1A 104K-T	B	13.6/29.4
C2052	4030016930	S.CER C1005 JB 1A 104K-T	B	25.5/15.3
C2053	4030017460	S.CER C1005 JB 1H 102K-T	B	27.4/10.4
C2054	4030016930	S.CER C1005 JB 1A 104K-T	T	25.5/12.4
C2055	4030017400	S.CER C1005 CH 1H 220J-T	B	11.0/20.3
C2056	4030017380	S.CER C1005 CH 1H 050B-T	T	27.2/10.7
C2057	4030016930	S.CER C1005 JB 1A 104K-T	B	24.1/10.4
C2058	4030016790	S.CER C1005 JB 1E 103K-T	B	28.8/13.7
C2059	4030017620	S.CER C1005 CH 1H 100C-T	B	18.9/6.2
C2060	4030016780	S.CER C1005 JB 1E 153K-T	B	12.2/11.7
C2062	4030018860	S.CER C1005 JB 0J 105K-T	T	9.4/20.1
C2063	4030017420	S.CER C1005 CH 1H 470J-T	T	2.1/14.7
C2064	4030017420	S.CER C1005 CH 1H 470J-T	T	2.5/13.5
C2065	4030017420	S.CER C1005 CH 1H 470J-T	T	3.8/13.0
C2066	4030017420	S.CER C1005 CH 1H 470J-T	T	6.5/16.5
C2067	4030017420	S.CER C1005 CH 1H 470J-T	T	7.5/24.0
C2068	4030017620	S.CER C1005 CH 1H 100C-T	T	19.5/5.3
C2069	4030017420	S.CER C1005 CH 1H 470J-T	T	27.5/17.2
C2070	4030016930	S.CER C1005 JB 1A 104K-T	B	21.0/12.5
C2071	4030016930	S.CER C1005 JB 1A 104K-T	B	21.7/19.7
C2072	4030016930	S.CER C1005 JB 1A 104K-T	B	17.2/23.8
C2073	4030016930	S.CER C1005 JB 1A 104K-T	B	20.2/16.0
C2074	4030017420	S.CER C1005 CH 1H 470J-T	T	13.1/5.3
C2075	4030017430	S.CER C1005 CH 1H 101J-T	B	18.3/15.9
C2076	4030016930	S.CER C1005 JB 1A 104K-T	T	7.7/27.1
C2077	4030019610	S.CER GRM155B31A105KE15D	B	41.2/6.1
C2078	4030017460	S.CER C1005 JB 1H 102K-T</		

[FRONT UNIT]

REF NO.	PARTS NO.	DESCRIPTION	M.	H/V LOCATION
IC6	1130015530	S.IC BU9795AKV-E2	T	59.9/17.4
IC7	1110002751	S.IC TA75S01F(TE85RF)	B	85.8/12.3
IC51	1140015010	S.IC HD64F2506RBR26DV(EMPTY)	B	67.5/21.9
IC52	1130015080	S.IC R1EX24512ASAS0A	B	92.3/15.4
IC53	1130011741	S.IC TC7W66FK(TE85LF)	B	24.3/22.0
IC54	1130007021	S.IC TC7S66FU(TE85LF)	B	28.8/19.5
Q1	1530002851	S.TRA 2SC4116-BL(TE85RF)	B	33.6/16.2
Q2	1590004090	S.TRA LDTCT114YET1G <SLVJ>	B	33.7/19.8
Q5	1590004090	S.TRA LDTCT114YET1G <SLVJ>	B	33.7/22.3
Q10	1590004090	S.TRA LDTCT114YET1G <SLVJ>	B	54.1/21.1
Q95	1590004090	S.TRA LDTCT114YET1G <SLVJ>	B	77.6/11.2
Q96	1590004150	S.TRA DRC9114TOL	B	17.1/12.8
Q97	1590004150	S.TRA DRC9114TOL	B	30.7/21.5
D1	1790001990	S.VAR EZJP0V080DA	T	12.4/17.1
D2	1790001990	S.VAR EZJP0V080DA	T	7.0/17.1
D3	1790001990	S.VAR EZJP0V080DA	B	17.7/10.6
D5	1750002170	S.DIO DB2S31400L [EUR-01]	B	48.6/6.3
	1750002170	S.DIO DB2S31400L [EXP-01]		
	1750002170	S.DIO DB2S31400L [EXP-02]		
	1790001241	S.DIO MA2S7280GL [USA-01]		
	1750002170	S.DIO DB2S31400L [USA-02]		
	1790001241	S.DIO MA2S7280GL [EXP-03]		
	1750002170	S.DIO DB2S31400L [EXP-04]		
	1790001241	S.DIO MA2S7280GL [EXP-06]		
	1750002170	S.DIO DB2S31400L [CHN-01]		
D60	1750001790	S.DIO 1SS390 TE61	B	80.2/13.0
X51	6050013160	S.XTA CR-912 TSS3225A 19.6608 MHz	B	84.0/16.9
L1	6200003640	S.COI MLF1608E 100K-T	B	11.6/17.1
L2	6200001981	S.COI NLV25T-1R0J	B	58.5/9.5
R7	7030005000	S.RES ERJ2GEJ 471 X (470)	B	35.7/16.2
R8	7030005000	S.RES ERJ2GEJ 471 X (470)	B	36.7/16.2
R9	7030007570	S.RES ERJ2GEJ 122 X (1.2K)	B	37.6/16.2
R11	7030009280	S.RES ERJ2GEJ 391 X	B	33.1/18.0
R12	7030009140	S.RES ERJ2GEJ 272 X (2.7K)	B	34.7/18.0
R14	7210003330	VAR RK09D1130A1N		
R15	7030005120	S.RES ERJ2GEJ 102 X (1K)	B	7.2/17.1
R16	7030005120	S.RES ERJ2GEJ 102 X (1K)	B	15.5/12.0
R18	7030005240	S.RES ERJ2GEJ 473 X (47K)	T	5.9/17.1
R19	7030005090	S.RES ERJ2GEJ 104 X (100K)	B	18.7/12.6
R20	7030010040	S.RES ERJ2GEJ-JPW	B	29.7/7.3
R40	7030005040	S.RES ERJ2GEJ 472 X (4.7K)	B	23.0/25.4
R41	7030007340	S.RES ERJ2GEJ 153 X (15K)	B	23.0/27.4
R42	7030005240	S.RES ERJ2GEJ 473 X (47K)	B	26.9/27.8
R43	7030007350	S.RES ERJ2GEJ 393 X (39K)	B	28.8/27.8
R44	7030005170	S.RES ERJ2GEJ 474 X (470K)	B	25.0/26.2
R46	7030004980	S.RES ERJ2GEJ 101 X (100)	B	33.4/3.3
R47	7030007300	S.RES ERJ2GEJ 332 X (3.3K)	B	33.4/5.1
R51	7030005090	S.RES ERJ2GEJ 104 X (100K)	B	51.0/6.3
R60	7030005090	S.RES ERJ2GEJ 104 X (100K)	B	84.0/8.6
R76	7030005120	S.RES ERJ2GEJ 102 X (1K)	T	10.4/17.1
R83	7030005090	S.RES ERJ2GEJ 104 X (100K)	B	40.0/14.7
R85	7030005090	S.RES ERJ2GEJ 104 X (100K)	B	57.7/27.5
R86	7030005090	S.RES ERJ2GEJ 104 X (100K)	B	56.7/25.0
R87	7030005090	S.RES ERJ2GEJ 104 X (100K)	B	59.1/28.1
R88	7030005090	S.RES ERJ2GEJ 104 X (100K)	B	56.3/6.9
R89	7030005090	S.RES ERJ2GEJ 104 X (100K)	B	86.9/19.8
R90	7030005090	S.RES ERJ2GEJ 104 X (100K)	B	86.2/26.0
R243	7030005530	S.RES ERJ2GEJ 100 X (10)	B	80.5/18.4
R244	7030005160	S.RES ERJ2GEJ 105 X (1M)	B	81.9/17.9
R627	7030005090	S.RES ERJ2GEJ 104 X (100K)	B	74.8/17.5
R628	7030005090	S.RES ERJ2GEJ 104 X (100K)	B	58.1/5.6
R631	7030005050	S.RES ERJ2GEJ 103 X (10K)	B	80.8/15.5
R632	7030005050	S.RES ERJ2GEJ 103 X (10K)	B	81.7/13.7
R633	7030005040	S.RES ERJ2GEJ 472 X (4.7K)	B	77.6/12.7
R635	7030005050	S.RES ERJ2GEJ 103 X (10K)	B	86.0/11.0
R636	7030005050	S.RES ERJ2GEJ 103 X (10K)	B	86.6/9.8
R637	7030005120	S.RES ERJ2GEJ 102 X (1K)	B	55.0/24.4
R638	7030005090	S.RES ERJ2GEJ 104 X (100K)	B	77.8/23.8
R639	7030005090	S.RES ERJ2GEJ 104 X (100K)	B	76.6/16.3
R651	7030005120	S.RES ERJ2GEJ 102 X (1K)	B	88.4/9.8
R652	7030005120	S.RES ERJ2GEJ 102 X (1K)	B	70.9/29.6
R657	7030005120	S.RES ERJ2GEJ 102 X (1K)	B	86.0/12.2
R688	7030005120	S.RES ERJ2GEJ 102 X (1K)	B	81.8/22.3
R763	7410001150	S.ARR EXB28V471JX	B	76.0/14.5
R765	7410001130	S.ARR EXB28V102JX	B	63.1/29.6
R767	7410001130	S.ARR EXB28V102JX	B	59.2/24.8
R768	7410001130	S.ARR EXB28V102JX	B	59.2/21.7
R769	7410001130	S.ARR EXB28V102JX	B	59.3/18.0
R770	7410001130	S.ARR EXB28V102JX	B	75.8/26.3
R771	7410001130	S.ARR EXB28V102JX	B	69.4/12.7
R772	7410001130	S.ARR EXB28V102JX	B	77.3/19.1
R773	7030005120	S.RES ERJ2GEJ 102 X (1K)	B	83.4/28.7
R774	7030005120	S.RES ERJ2GEJ 102 X (1K)	B	86.5/23.2
R775	7030005090	S.RES ERJ2GEJ 104 X (100K)	B	59.2/5.6
R776	7030005090	S.RES ERJ2GEJ 104 X (100K)	B	56.0/19.8
R777	7030005090	S.RES ERJ2GEJ 104 X (100K)	B	82.3/23.8
R778	7030005090	S.RES ERJ2GEJ 104 X (100K)	B	76.5/17.2
R779	7030005090	S.RES ERJ2GEJ 104 X (100K)	B	67.3/29.3
R780	7030005210	S.RES ERJ2GEJ 822 X (8.2K)	B	23.0/29.4
R781	7030007340	S.RES ERJ2GEJ 153 X (15K)	B	23.0/28.4
R782	7030005090	S.RES ERJ2GEJ 104 X (100K)	B	75.6/22.7
R783	7030005090	S.RES ERJ2GEJ 104 X (100K)	B	58.5/29.4
R784	7030005240	S.RES ERJ2GEJ 473 X (47K)	B	26.5/18.8
R785	7030005240	S.RES ERJ2GEJ 473 X (47K)	B	30.8/19.3

[FRONT UNIT]

REF NO.	PARTS NO.	DESCRIPTION	M.	H/V LOCATION
C2	4030017420	S.CER C1005 CH 1H 470J-T	B	84.0/7.7
C3	4030017420	S.CER C1005 CH 1H 470J-T	B	28.5/6.1
C4	4030017420	S.CER C1005 CH 1H 470J-T	B	47.2/5.0
C5	4030017420	S.CER C1005 CH 1H 470J-T	B	56.3/4.6
C8	4030017460	S.CER C1005 JB 1H 102K-T	B	13.7/17.1
C9	4030017460	S.CER C1005 JB 1H 102K-T	T	11.3/17.1
C10	4030017460	S.CER C1005 JB 1H 102K-T	T	20.3/13.1
C12	4030017460	S.CER C1005 JB 1H 102K-T	T	18.3/13.1
C25	4030016970	S.CER C1005 JB 1E 103K-T	B	26.9/28.9
C26	4030016930	S.CER C1005 JB 1A 104K-T	B	23.0/26.4
C27	4030017680	S.CER C1005 CH 1H 820J-T	B	25.0/27.1
C28	4030016930	S.CER C1005 JB 1A 104K-T	B	30.6/27.1
C31	4030016930	S.CER C1005 JB 1A 104K-T	B	33.4/4.2
C34	4030017420	S.CER C1005 CH 1H 470J-T	B	56.3/5.5
C41	4030017460	S.CER C1005 JB 1H 102K-T	B	25.0/29.0
C50	4030017420	S.CER C1005 CH 1H 470J-T	B	61.6/8.6
C75	4030016930	S.CER C1005 JB 1A 104K-T	B	43.8/14.7
C76	4030016930	S.CER C1005 JB 1A 104K-T	B	28.8/28.9
C78	4030017460	S.CER C1005 JB 1H 102K-T	B	8.9/17.1
C84	4030017420	S.CER C1005 CH 1H 470J-T	B	29.9/2.9
C87	4030016930	S.CER C1005 JB 1A 104K-T	B	30.9/18.0
C93	4030017460	S.CER C1005 JB 1H 102K-T	B	56.3/7.9
C114	4030017420	S.CER C1005 CH 1H 470J-T	B	19.7/10.6
C126	4030017460	S.CER C1005 JB 1H 102K-T	B	25.2/4.2
C128	4030016930	S.CER C1005 JB 1A 104K-T	T	14.6/19.3
C129	4030017460	S.CER C1005 JB 1H 102K-T	T	13.7/19.6
C130	4030017460	S.CER C1005 JB 1H 102K-T	B	85.7/8.6
C131	4030017460	S.CER C1005 JB 1H 102K-T	B	86.9/21.0
C132	4030017460	S.CER C1005 JB 1H 102K-T	B	86.2/26.9
C626	4030017640	S.CER C1005 CH 1H 150J-T	B	81.1/19.6
C627	4030017580	S.CER C1005 CH 1H 060C-T	B	80.0/17.0
C628	4030017640	S.CER C1005 CH 1H 150J-T	B	81.0/17.0
C629	4030016930	S.CER C1005 JB 1A 104K-T	B	79.4/15.1
C630	4030016930	S.CER C1005 JB 1A 104K-T	B	76.2/12.3
C631	4030016930	S.CER C1005 JB 1A 104K-T	B	56.1/29.6
C797	4030016930	S.CER C1005 JB 1A 104K-T	B	75.6/21.5
C799	4030016930	S.CER C1005 JB 1A 104K-T	B	77.2/22.4
C800	4030016930	S.CER C1005 JB 1A 104K-T	B	77.2/21.2
C802	4030016930	S.CER C1005 JB 1A 104K-T	B	64.7/9.9
C803	4030019990	S.CER C1005 JB 1C 104K-T	B	49.7/24.9
C804	4030017460	S.CER C1005 JB 1H 102K-T	B	26.6/22.1
C805	4030018900	S.CER C1005 JB 0J 474K-T	B	65.3/29.3
C806	4550006970	S.TAN TEESVA0G476M8R	B	43.4/6.5
C807	4030016930	S.CER C1005 JB 1A 104K-T	B	75.4/20.4
C808	4030016930	S.CER C1005 JB 1A 104K-T	B	78.8/17.1
C809	4030016930	S.CER C1005 JB 1A 104K-T	B	88.6/15.1
C810	4030016930	S.CER C1005 JB 1A 104K-T	B	25.0/28.1
C811	4030017460	S.CER C1005 JB 1H 102K-T	B	31.5/8.0
J1	6450002210	CON 3017-8821 <KIN>		
J2	6510027960	S.CON 04-6294-040-000-800	B	71.0/5.7
J3	6510025142	S.CON 10FLT-SM2-TB(LF)(SN)(M)	B	51.6/28.5
DS1	5040003510	S.LED LNJ426W83RA	T	64.8/23.5
DS2	5040003510	S.LED LNJ426W83RA	T	58.2/23.5
DS3	5040003510	S.LED LNJ426W83RA	T	51.6/23.5
DS4	5040003510	S.LED LNJ426W83RA	T	31.8/23.5
DS5	5040003510	S.LED LNJ426W83RA	T	38.4/23.5
DS6	5040003510	S.LED LNJ426W83RA	T	45.0/23.5
DS7	5040003510	S.LED LNJ426W83RA	T	82.6/22.1
DS8	5040003510	S.LED LNJ426W83RA	T	65.3/5.0
DS9	5040003510	S.LED LNJ426W83RA	T	36.3/5.0
DS11	5030003390	LCD TAK-35877 FX-3331<ITAK>		
SP1	2510001221	SPE C052SB500-14 <OSC>		
W1	8900010503	CAB OPC-1046B-1(P0.5N40L55) <TJM>		
EP2	8930059170	LCD SRCN-2622-SP-N-W (SHJ)		

M.=Mounted side (T: Mounted on the Top side, B: Mounted on the Bottom side) S.=Surface mount

[MAIN-C UNIT] (For [350 MHz band] versions)

REF NO.	PARTS NO.	DESCRIPTION	M.	H/V LOCATION
IC2	1110002751	S.IC TA75S01F(TE85RF)	T	60.0/54.9
IC3	1150002231	IC RA55H3340M-121		
IC4	1110007320	S.IC NJM2591V-TE1-#ZZZB	T	57.8/24.7
IC5	1110006230	S.IC NJM2711F-TE1-#ZZZB	B	38.8/27.0
IC6	1110002751	S.IC TA75S01F(TE85RF)	B	59.9/17.4
IC7	1130011741	S.IC TCTW66FK(TE85LF)	T	85.8/12.3
IC8	1130015271	S.IC AK1541P4-L	B	78.2/23.7
IC1001	1180003660	S.REG XCG408EN22PR-G	B	96.9/10.8
IC1002	1180003500	S.REG NJM7808DL1A-TE1-#FZZB	T	123.3/45.7
IC1004	1110002751	S.IC TA75S01F(TE85RF)	B	119.7/13.0
IC1005	1110007630	S.IC NJM2783V-TE1-#ZZZH	T	47.4/18.9
IC1006	1110007290	S.IC AK2330P-L	B	53.7/11.5
IC1007	1110005320	S.IC NJM13403V-TE1-#ZZZB	B	37.4/17.0
IC1008	1130009981	S.IC TCTW53FK(TE85LF)	T	40.3/19.7
IC1009	1110003091	IC LA4425A-E		
IC2001	1180003680	S.REG TPS62204DBVR	B	32.4/6.5
IC2002	1190002900	S.IC ADS7886SDCKR	B	14.4/9.3
IC2006	1110007770	S.IC PCM3008T/2K	T	16.3/8.3
IC2007	1140013290	S.IC TMS320VC5509AZHH	T	18.0/18.4
IC2008	1130015620	S.IC EN25Q40-100GIP <MSK>	B	12.5/25.3
IC2009	1110006230	S.IC NJM2711F-TE1-#ZZZB	B	26.7/12.7
IC2010	1180003600	S.REG NJM2871BF05-TE1-#ZZZB	B	39.0/6.8
Q1	1590004090	S.TRA LDTC114YET1G <SLVJ>	B	47.2/27.1
Q2	1580000731	S.FET 3SK293(TE85LF)	B	41.5/38.7
Q3	1560000541	S.FET 2SK880-Y(T5RICOMF)	T	77.2/24.5
Q4	1530002851	S.TRA 2SC4116-BL(TE85RF)	B	67.9/25.4
Q5	1530002851	S.TRA 2SC4116-BL(TE85RF)	T	44.9/25.3
Q6	1590004090	S.TRA LDTC114YET1G <SLVJ>	T	62.2/52.2
Q7	1560000841	S.FET 2SK1829(TE85RF)	T	33.7/39.7
Q8	1530002680	S.TRA 2SC3357-T1	B	90.4/52.8
Q9	1560001360	S.FET 2SK3019 TL	T	52.2/26.3
Q10	1530003311	S.TRA 2SC5107-O(TE85RF)	B	92.8/33.1
Q11	1530003311	S.TRA 2SC5107-O(TE85RF)	B	100.5/31.7
Q12	1530004110	S.TRA MTS337T(TE85LF)	B	97.6/30.4
Q13	1590004090	S.TRA LDTC114YET1G <SLVJ>	B	57.6/27.2
Q14	1530003311	S.TRA 2SC5107-O(TE85RF)	T	64.8/24.9
Q15	1590004500	S.TRA DMC561040R	T	101.0/34.4
Q17	1530002851	S.TRA 2SC4116-BL(TE85RF)	T	107.7/33.4
Q18	1590004090	S.TRA LDTC114YET1G <SLVJ>	T	81.5/40.8
Q19	1580000731	S.FET 3SK293(TE85LF)	B	71.4/38.4
Q20	1530002851	S.TRA 2SC4116-BL(TE85RF)	T	60.0/49.8
Q21	1590004090	S.TRA LDTC114YET1G <SLVJ>	T	49.5/24.8
Q23	1530002921	S.TRA 2SC4226-T1 Y25 (R25)	B	105.2/30.9
Q24	1530002921	S.TRA 2SC4226-T1 Y25 (R25)	B	98.3/24.2
Q25	1530003260	S.TRA 2SC5006-T1	B	84.9/51.5
Q1001	1590004090	S.TRA LDTC114YET1G <SLVJ>	T	110.6/44.1
Q1003	1550000190	S.FET 2SJ506STR-E	T	115.3/45.4
Q1004	1590004090	S.TRA LDTC114YET1G <SLVJ>	T	114.0/26.7
Q1005	1590004090	S.TRA LDTC114YET1G <SLVJ>	T	114.0/24.7
Q1007	1590004090	S.TRA LDTC114YET1G <SLVJ>	B	116.3/8.1
Q1008	1590000990	S.TRA DTC363EK T146	B	128.9/17.8
Q1009	1590001451	S.FET 2SJ144-GR (TE85RF)	B	113.8/11.1
Q1010	1590004090	S.TRA LDTC114YET1G <SLVJ>	B	116.1/10.9
Q1011	1540000550	S.TRA 2SD1664 T100Q	B	125.1/47.6
Q1012	1590004090	S.TRA LDTC114YET1G <SLVJ>	B	130.9/20.7
Q1013	1510000920	S.TRA 2SA1577 T106 Q	T	107.7/44.3
Q1014	1520000460	S.TRA 2SB1132 T100 R	B	123.5/21.1
Q1015	1590004590	S.TRA DMC506010R	B	118.9/20.4
Q1016	1590004090	S.TRA LDTC114YET1G <SLVJ>	T	107.8/39.2
Q1017	1520000460	S.TRA 2SB1132 T100 R	T	120.1/35.2
Q1018	1590004090	S.TRA LDTC114YET1G <SLVJ>	B	126.4/43.3
Q1019	1590004590	S.TRA DMC506010R	B	123.8/35.8
Q1020	1590004090	S.TRA LDTC114YET1G <SLVJ>	T	42.6/22.5
Q1021	1590004090	S.TRA LDTC114YET1G <SLVJ>	B	126.4/41.3
Q2001	1590004040	S.TRA LDA1123YET1G <SLVJ>	B	26.9/26.6
D2	1750001910	S.DIO HVD144AKRF-E	B	52.6/28.5
D3	1750001910	S.DIO HVD144AKRF-E	B	52.6/27.3
D4	1750000711	S.VAR HVC350BTRF-E	B	36.0/40.2
D5	1750002060	S.DIO RN752TE-21	T	26.5/53.3
D7	1750001910	S.DIO HVD144AKRF-E	B	25.3/45.3
D8	1750001910	S.DIO HVD144AKRF-E	B	43.4/27.3
D9	1750001910	S.DIO HVD144AKRF-E	B	43.4/28.6
D10	1750000711	S.VAR HVC350BTRF-E	B	55.5/39.9
D11	1750001820	S.DIO LRB706F-40T1G <SLVJ>	B	8.2/49.9
D12	1750001820	S.DIO LRB706F-40T1G <SLVJ>	B	22.8/49.9
D13	1750001910	S.DIO HVD144AKRF-E	T	68.3/28.1
D14	1750001910	S.DIO HVD144AKRF-E	T	69.5/28.1
D15	1790001261	S.DIO MA2S077G0L	B	82.2/39.2
D16	1750000711	S.VAR HVC350BTRF-E	B	106.7/20.3
D17	1750001910	S.DIO HVD144AKRF-E	T	70.6/41.6
D18	1750001910	S.DIO HVD144AKRF-E	T	74.5/41.6
D19	1750000711	S.VAR HVC350BTRF-E	B	61.9/39.9
D20	1750000711	S.VAR HVC350BTRF-E	B	28.0/40.2
D21	1750000711	S.VAR HVC350BTRF-E	B	36.0/41.6
D22	1750000711	S.VAR HVC350BTRF-E	B	28.0/41.6
D23	1750000711	S.VAR HVC350BTRF-E	B	52.8/42.6
D24	1750002060	S.DIO RN752TE-21	T	35.1/56.7
D25	1750000581	S.DIO 1SV307(TPH3F)	B	83.5/42.1
D26	1750001650	S.VAR 1SV309(TPH3F)	B	101.8/25.9
D29	1750001820	S.DIO LRB706F-40T1G <SLVJ>	B	19.2/49.9
D33	1750000711	S.VAR HVC350BTRF-E	B	97.8/20.5
D62	1750000711	S.VAR HVC350BTRF-E	B	91.7/22.8
D64	1750000711	S.VAR HVC350BTRF-E	B	106.7/21.5
D66	1750000370	S.DIO DA221 TL	T	33.7/37.1
D67	1790001241	S.DIO MA2S7280GL	T	31.8/39.7
D1002	1790000700	DIO DSA3A1		
D1003	1750000370	S.DIO DA221 TL	B	114.0/8.2
D1004	1750000370	S.DIO DA221 TL	B	114.1/6.1
D1005	1750000370	S.DIO DA221 TL	T	113.2/7.4
D1006	1750000370	S.DIO DA221 TL	T	113.0/10.3
D1007	1750001810	S.DIO L1SS400T1G <SLVJ>	B	129.0/20.7

[MAIN-C UNIT] (For [350 MHz band] versions)

REF NO.	PARTS NO.	DESCRIPTION	M.	H/V LOCATION
D1008	1750000370	S.DIO DA221 TL	B	124.0/43.3
D2002	1790001241	S.DIO MA2S7280GL	T	24.9/18.0
D2003	1790001241	S.DIO MA2S7280GL	T	10.7/30.5
D2004	1790001241	S.DIO MA2S7280GL	T	22.1/21.4
D2005	1790001241	S.DIO MA2S7280GL	B	17.5/26.3
D2006	1790001241	S.DIO MA2S7280GL	T	12.0/25.3
D2008	1750002020	S.DIO DA2S10100L	T	100.3/6.5
F11	2020002570	CER LTM450HW <JJE>		
F12	2020002410	CER LTM450FW <JJE>		
F13	2020002610	S.CER LTUCG450G <JJE>	T	36.3/28.0
F14	2030000870	S.MON MFT46.3P3 46.350 MHz (FL-442)	T	66.9/34.9
F15	2010002760	S.XTA MFT46.3J 46.350 MHz (FL-448)	T	75.8/34.9
F16	2040001440	S.LC NFE31PT152Z1E9L (NFM60R20T152)	B	97.7/62.2
F17	2040001440	S.LC NFE31PT152Z1E9L (NFM60R20T152)	B	97.7/58.9
F18	2040001440	S.LC NFE31PT152Z1E9L (NFM60R20T152)	B	97.7/55.4
X1	6070000300	S.DIS JTBM450CX24 <JJE>	B	51.4/22.0
X2	6050013000	S.XTA CR-892 TTS14VSB-A8 15.3 MHz	B	71.5/21.5
X2001	6050013170	S.XTA CR-914 TTS18VSE-A11 12.288 MHz	B	27.0/18.2
L1	6200010150	S.COI AS080340-15N	B	8.4/62.7
L2	6200010150	S.COI AS080340-15N	B	12.9/55.5
L3	6200010150	S.COI AS080340-15N	B	20.7/55.5
L4	6200013100	S.COI 0.45-1.5-5TL 18.3N <COMO>	T	31.1/50.5
L5	6200010420	S.COI FHW1210HC 1R0JGT <JJE>	T	38.5/58.4
L6	6200010150	S.COI AS080340-15N	B	27.3/55.5
L7	6200012870	S.COI 0.30-1.4-5-STR 23.5N <COMO>	B	28.8/37.8
L8	6200012870	S.COI 0.30-1.4-5-STR 23.5N <COMO>	B	35.2/37.8
L9	6200012170	S.COI MLG1608S R18J-T	B	65.8/24.7
L10	6200011690	S.COI C2520C-12NG-A	B	49.0/39.8
L11	6200011690	S.COI C2520C-12NG-A	B	57.8/40.5
L12	6200012170	S.COI MLG1608S R18J-T	B	62.3/22.4
L13	6200007891	S.COI ELJRF 27NJFB	T	85.1/29.9
L16	6200010150	S.COI AS080340-15N	B	38.2/65.2
L17	6200005581	S.COI ELJRE 2N2ZFA	B	85.4/57.9
L18	6200005701	S.COI ELJRE 22NGFA	B	88.1/58.9
L19	6200005711	S.COI ELJRE 27NGFA	B	89.9/56.0
L20	6200010090	S.COI ELJND R82JF	B	68.9/40.9
L21	6200005721	S.COI ELJRE 33NGFA	B	90.8/33.1
L22	6200005721	S.COI ELJRE 33NGFA	B	99.5/33.8
L23	6200005701	S.COI ELJRE 22NGFA	B	84.9/53.2
L27	6200007370	S.COI ELJFC R82K-F	B	103.2/21.4
L28	6200011860	S.COI LQW18ANR47G00D	T	94.7/17.3
L36	6200006991	S.COI ELJRE 56NGFA	B	73.5/38.5
L37	6200006981	S.COI ELJRE R10GFA	T	82.6/62.9
L38	6200014300	S.COI C36-4.7J <COMO>	B	106.2/24.9
L39	6200013710	S.COI C36-8NH <COMO>	B	92.9/20.2
L41	6200005721	S.COI ELJRE 33NGFA	B	95.8/29.8
L53	6200005721	S.COI ELJRE 33NGFA	B	78.0/39.2
L54	6200007370	S.COI ELJFC R82K-F	T	100.0/30.4
L55	6200004741	S.COI NLV25T-1R2J	B	103.7/33.8
L56	6200011690	S.COI C2520C-12NG-A	B	64.2/40.5
L57	6200011860	S.COI LQW18ANR47G00D	B	92.6/24.0
L58	6200011860	S.COI LQW18ANR47G00D	B	105.9/19.1
L1001	6200004660	S.COI MLF1608A 1R8K-T	T	79.8/13.3
L2001	6200014160	S.COI VLFC4028T-100M1R0-2	T	35.9/7.6
L2002	6200007830	S.COI ELJFC 4R7K-F	B	31.2/11.2
R1	7030000620	S.RES MCR10EZJH 100 K (104)	B	12.3/65.5
R4	7030003560	S.RES ERJ3GEYJ 103 V (10K)	B	16.4/50.6
R5	7030005220	S.RES ERJ2GEJ 223 X (22K)	B	11.2/49.6
R6	7030005220	S.RES ERJ2GEJ 223 X (22K)	B	19.8/48.1
R7	7030003560	S.RES ERJ3GEYJ 103 V (10K)	B	8.2/53.2
R8	7030006070	S.RES ERJ12YJ101U (100)	B	45.7/51.9
R9	7030003560	S.RES ERJ3GEYJ 103 V (10K)	B	25.6/50.6
R10	7030005220	S.RES ERJ2GEJ 223 X (22K)	B	22.2/48.1
R11	7030005050	S.RES ERJ2GEJ 103 X (10K)	B	31.5/40.5
R12	7030004980	S.RES ERJ2GEJ 101 X (100)	B	39.2/39.5
R13	7030005050	S.RES ERJ2GEJ 103 X (10K)	B	32.5/40.5
R14	7030005050	S.RES ERJ2GEJ 103 X (10K)	B	32.5/38.8
R15	7030005700	S.RES ERJ2GEJ 274 X (270K)	B	39.2/38.6
R16	7030004980	S.RES ERJ2GEJ 101 X (100)	B	39.5/40.7
R17	7030005530	S.RES ERJ2GEJ 100 X (10)	B	51.5/40.2
R18	7030005050	S.RES ERJ2GEJ 103 X (10K)	B	60.8/40.5
R19	7030005090	S.RES ERJ2GEJ 104 X (100K)	B	39.2/36.8
R20	7030005120	S.RES ERJ2GEJ 102 X (1K)	B	52.8/38.6
R21	7030005050	S.RES ERJ2GEJ 103 X (10K)	B	54.1/40.6
R22	7030005050	S.RES ERJ2GEJ 103 X (10K)	B	56.2/37.4
R23	7030005050	S.RES ERJ2GEJ 103 X (10K)	B	54.1/41.2
R29	7030005570	S.RES ERJ2GEJ 820 X (82)	B	74.0/40.6
R30	7030007300	S.RES ERJ2GEJ 332 X (3.3K)	B	71.3/41.2
R31	7030004980	S.RES ERJ2GEJ 101 X (100)	B	66.9/37.4
R33	7030005600	S.RES ERJ2GEJ 273 X (27K)	T	71.9/42.7
R34	7030005110	S.RES ERJ2GEJ 224 X (220K)	T	64.9/23.1
R35	7030005530	S.RES ERJ2GEJ 100 X (10)	T	64.9/22.2
R36	7030005030	S.RES ERJ2GEJ 152 X (1.5K)	B	56.2/21.7
R37	7030008400	S.RES ERJ2GE		

[MAIN-C UNIT] (For [350 MHz band] versions)

REF NO.	PARTS NO.	DESCRIPTION	M.	H/V LOCATION
R48	7030008300	S.RES ERJ2GJEJ 184 X (180K)	T	56.8/53.2
R49	7520000241	S.POS PRF18BC471QBSRB	T	47.3/53.2
R50	7030005050	S.RES ERJ2GJEJ 103 X (10K)	B	80.1/37.9
R51	7030005080	S.RES ERJ2GJEJ 823 X (82K)	T	61.8/49.8
R52	7030005070	S.RES ERJ2GJEJ 683 X (68K)	T	58.7/52.1
R53	7030004990	S.RES ERJ2GJEJ 221 X (220)	T	57.8/53.2
R54	7030005220	S.RES ERJ2GJEJ 223 X (22K)	B	58.8/55.7
R56	7030005110	S.RES ERJ2GJEJ 224 X (220K)	T	63.3/55.0
R57	7030005050	S.RES ERJ2GJEJ 103 X (10K)	B	58.8/54.8
R58	7030005570	S.RES ERJ2GJEJ 820 X (82)	T	64.2/55.0
R59	7030007350	S.RES ERJ2GJEJ 393 X (39K)	T	59.7/52.1
R61	7030004970	S.RES ERJ2GJEJ 470 X (47)	B	90.5/49.5
R62	7030008290	S.RES ERJ2GJEJ 183 X (18K)	B	89.6/49.5
R66	7030005090	S.RES ERJ2GJEJ 104 X (100K)	B	84.9/49.1
R67	7030004980	S.RES ERJ2GJEJ 101 X (100)	B	83.0/47.3
R68	7030005050	S.RES ERJ2GJEJ 103 X (10K)	B	82.6/48.7
R69	7030005040	S.RES ERJ2GJEJ 472 X (4.7K)	B	84.0/38.0
R70	7030004990	S.RES ERJ2GJEJ 221 X (220)	B	92.8/35.8
R71	7030007260	S.RES ERJ2GJEJ 330 X (33)	B	95.3/33.8
R72	7030004980	S.RES ERJ2GJEJ 101 X (100)	B	86.5/49.1
R73	7030004980	S.RES ERJ2GJEJ 101 X (100)	B	99.5/35.3
R74	7030005080	S.RES ERJ2GJEJ 823 X (82K)	B	101.3/33.7
R75	7030005720	S.RES ERJ2GJEJ 563 X (56K)	B	97.6/32.2
R76	7030005030	S.RES ERJ2GJEJ 152 X (1.5K)	B	96.7/32.2
R77	7030005120	S.RES ERJ2GJEJ 102 X (1K)	T	105.6/36.0
R78	7030009270	S.RES ERJ2GJEJ 821 X (820)	T	102.5/32.5
R79	7030006020	S.RES RR0510P-682-D (6.8K)	B	96.5/23.7
R80	7030005120	S.RES ERJ2GJEJ 102 X (1K)	T	100.0/32.5
R83	7030006020	S.RES RR0510P-682-D (6.8K)	B	106.4/29.1
R84	7030006020	S.RES RR0510P-682-D (6.8K)	B	106.4/28.2
R85	7030006020	S.RES RR0510P-682-D (6.8K)	B	95.6/25.3
R86	7030005110	S.RES ERJ2GJEJ 224 X (220K)	B	102.6/24.4
R87	7030005530	S.RES ERJ2GJEJ 100 X (10)	B	102.6/27.5
R89	7030005050	S.RES ERJ2GJEJ 103 X (10K)	T	79.0/25.0
R90	7030005170	S.RES ERJ2GJEJ 474 X (470K)	T	95.9/13.3
R92	7030005100	S.RES ERJ2GJEJ 154 X (150K)	T	94.3/14.4
R93	7030005600	S.RES ERJ2GJEJ 273 X (27K)	B	81.3/25.8
R95	7030005710	S.RES ERJ2GJEJ 121 X (120)	B	83.8/24.5
R96	7030008400	S.RES ERJ2GJEJ 182 X (1.8K)	B	83.8/23.5
R97	7030010040	S.RES ERJ2GJEJ-JPW	B	82.2/24.5
R98	7030007290	S.RES ERJ2GJEJ 222 X (2.2K)	T	109.5/33.8
R100	7030005240	S.RES ERJ2GJEJ 473 X (47K)	T	76.1/20.3
R101	7030004980	S.RES ERJ2GJEJ 101 X (100)	T	77.9/22.2
R123	7030005530	S.RES ERJ2GJEJ 100 X (10)	B	68.2/40.4
R125	7030008370	S.RES ERJ2GJEJ 561 X (56K)	T	65.6/29.2
R171	7030004980	S.RES ERJ2GJEJ 101 X (100)	T	45.5/28.6
R172	7030008300	S.RES ERJ2GJEJ 184 X (180K)	T	44.2/27.1
R173	7030005120	S.RES ERJ2GJEJ 102 X (1K)	T	42.9/26.4
R174	7030005290	S.RES ERJ2GJEJ 682 X (6.8K)	T	42.0/28.8
R175	7030009290	S.RES ERJ2GJEJ 562 X (5.6K)	T	41.6/27.6
R176	7030005030	S.RES ERJ2GJEJ 152 X (1.5K)	T	42.0/26.4
R178	7030004970	S.RES ERJ2GJEJ 470 X (47)	B	39.8/24.4
R211	7030004970	S.RES ERJ2GJEJ 470 X (47)	T	82.7/28.3
R212	7030010040	S.RES ERJ2GJEJ-JPW	T	82.6/60.4
R234	7030005070	S.RES ERJ2GJEJ 683 X (68K)	B	92.8/34.9
R235	7030004980	S.RES ERJ2GJEJ 101 X (100)	B	81.0/37.9
R236	7030007570	S.RES ERJ2GJEJ 122 X (1.2K)	B	67.4/22.7
R237	7030007060	S.RES ERJ2GJEJ 684X (680K)	B	67.4/23.6
R289	7030005090	S.RES ERJ2GJEJ 104 X (100K)	T	95.9/12.6
R290	7030005010	S.RES ERJ2GJEJ 681 X (680)	T	63.2/23.1
R291	7030005090	S.RES ERJ2GJEJ 104 X (100K)	T	94.3/13.5
R293	7030006610	S.RES ERJ2GJEJ 394 X (390K)	T	88.4/12.0
R295	7030006610	S.RES ERJ2GJEJ 394 X (390K)	T	101.0/17.3
R299	7030008300	S.RES ERJ2GJEJ 184 X (180K)	B	74.6/38.5
R300	7030005720	S.RES ERJ2GJEJ 563 X (56K)	B	76.8/40.6
R301	7030005100	S.RES ERJ2GJEJ 154 X (150K)	B	67.5/40.5
R302	7030005720	S.RES ERJ2GJEJ 563 X (56K)	B	66.9/38.3
R308	7030009140	S.RES ERJ2GJEJ 272 X (2.7K)	T	56.9/54.9
R311	7030010040	S.RES ERJ2GJEJ-JPW	B	94.9/32.2
R317	7030005120	S.RES ERJ2GJEJ 102 X (1K)	T	105.6/37.4
R319	7030007340	S.RES ERJ2GJEJ 153 X (15K)	T	37.3/37.9
R320	7030005170	S.RES ERJ2GJEJ 474 X (470K)	T	35.5/36.2
R328	7030010040	S.RES ERJ2GJEJ-JPW	B	104.8/29.1
R334	7030007280	S.RES ERJ2GJEJ 331 X (330)	T	87.6/61.3
R337	7030005300	S.RES ERJ2GJEJ 150 X (15)	T	87.1/62.7
R338	7030007280	S.RES ERJ2GJEJ 331 X (330)	T	87.6/64.1
R339	7030010040	S.RES ERJ2GJEJ-JPW	B	96.5/25.3
R340	7030005050	S.RES ERJ2GJEJ 103 X (10K)	B	72.4/25.3
R350	7030005600	S.RES ERJ2GJEJ 273 X (27K)	B	52.9/26.2
R351	7030005600	S.RES ERJ2GJEJ 273 X (27K)	B	43.2/26.3
R352	7030007300	S.RES ERJ2GJEJ 332 X (3.3K)	B	50.9/26.8
R353	7030005210	S.RES ERJ2GJEJ 822 X (8.2K)	B	45.4/27.3
R354	7030005210	S.RES ERJ2GJEJ 822 X (8.2K)	B	46.1/29.0
R394	7030010040	S.RES ERJ2GJEJ-JPW	B	100.1/27.3
R395	7030010040	S.RES ERJ2GJEJ-JPW	B	26.7/46.8
R478	7030007340	S.RES ERJ2GJEJ 153 X (15K)	B	35.5/26.8
R479	7030005600	S.RES ERJ2GJEJ 273 X (27K)	T	66.8/27.4
R483	7030007300	S.RES ERJ2GJEJ 332 X (3.3K)	T	71.5/28.8
R484	7030007300	S.RES ERJ2GJEJ 332 X (3.3K)	T	76.5/42.5
R485	7030010040	S.RES ERJ2GJEJ-JPW	T	77.0/40.4
R486	7030005000	S.RES ERJ2GJEJ 471 X (470)	T	73.2/29.7
R488	7030007300	S.RES ERJ2GJEJ 332 X (3.3K)	T	68.6/42.5
R489	7030007300	S.RES ERJ2GJEJ 332 X (3.3K)	T	68.5/29.7
R490	7030005120	S.RES ERJ2GJEJ 102 X (1K)	T	81.3/42.2
R492	7030005090	S.RES ERJ2GJEJ 104 X (100K)	B	80.0/27.2
R500	7030010040	S.RES ERJ2GJEJ-JPW	B	49.8/16.5
R504	7030005090	S.RES ERJ2GJEJ 104 X (100K)	T	75.3/17.9
R505	7030005290	S.RES ERJ2GJEJ 682 X (6.8K)	T	76.1/22.7
R506	7030005050	S.RES ERJ2GJEJ 103 X (10K)	T	74.8/21.5
R613	7030005120	S.RES ERJ2GJEJ 102 X (1K)	T	81.2/39.3
R614	7030005030	S.RES ERJ2GJEJ 152 X (1.5K)	B	56.2/24.3
R615	7030005040	S.RES ERJ2GJEJ 472 X (4.7K)	T	50.7/27.7
R616	7030008300	S.RES ERJ2GJEJ 184 X (180K)	B	59.9/19.6
R617	7030005090	S.RES ERJ2GJEJ 104 X (100K)	B	57.4/15.8
R618	7030004980	S.RES ERJ2GJEJ 101 X (100)	B	62.1/16.9

[MAIN-C UNIT] (For [350 MHz band] versions)

REF NO.	PARTS NO.	DESCRIPTION	M.	H/V LOCATION
R619	7030005030	S.RES ERJ2GJEJ 152 X (1.5K)	B	36.0/27.5
R620	7030005240	S.RES ERJ2GJEJ 473 X (4.7K)	B	57.4/18.4
R621	7410001130	S.ARR EXB28V102JX	B	76.6/19.6
R622	7030007570	S.RES ERJ2GJEJ 122 X (1.2K)	B	83.8/21.6
R623	7030005090	S.RES ERJ2GJEJ 104 X (100K)	T	50.7/26.1
R624	7030005090	S.RES ERJ2GJEJ 104 X (100K)	T	83.2/11.6
R625	7030010040	S.RES ERJ2GJEJ-JPW	B	96.1/20.1
R1003	7030007601	S.RES ERA3YKD 913V (91K)	B	72.6/9.4
R1004	7030006101	S.RES ERA3YED 183V (18K)	B	70.2/10.2
R1005	7030005120	S.RES ERJ2GJEJ 102 X (1K)	T	112.3/16.5
R1006	7030005090	S.RES ERJ2GJEJ 104 X (100K)	B	112.4/8.1
R1008	7030001040	S.RES ERJ2GJEJ-JPW	T	124.9/24.8
R1009	7030005050	S.RES ERJ2GJEJ 103 X (10K)	T	133.3/49.2
R1010	7030005050	S.RES ERJ2GJEJ 103 X (10K)	T	128.6/23.8
R1012	7030005040	S.RES ERJ2GJEJ 472 X (4.7K)	T	110.6/46.0
R1013	7030005240	S.RES ERJ2GJEJ 473 X (47K)	T	114.7/49.0
R1014	7030005090	S.RES ERJ2GJEJ 104 X (100K)	T	98.3/12.1
R1015	7030005120	S.RES ERJ2GJEJ 102 X (1K)	B	115.3/22.8
R1016	7030005090	S.RES ERJ2GJEJ 104 X (100K)	B	115.6/6.1
R1018	7030005090	S.RES ERJ2GJEJ 104 X (100K)	T	111.7/7.0
R1020	7030005090	S.RES ERJ2GJEJ 104 X (100K)	B	114.7/24.9
R1021	7030005120	S.RES ERJ2GJEJ 102 X (1K)	B	116.5/6.1
R1022	7030005120	S.RES ERJ2GJEJ 102 X (1K)	T	114.9/7.1
R1023	7030005050	S.RES ERJ2GJEJ 103 X (10K)	B	125.2/15.7
R1024	7030007290	S.RES ERJ2GJEJ 222 X (2.2K)	B	131.6/17.6
R1025	7030000480	S.RES MCR10EZHJ 6.8K (682)	B	129.4/47.0
R1026	7030000480	S.RES MCR10EZHJ 6.8K (682)	B	129.4/48.8
R1027	7030010040	S.RES ERJ2GJEJ-JPW	T	113.7/16.5
R1028	7030004970	S.RES ERJ2GJEJ 470 X (47)	B	114.9/13.4
R1029	7030005120	S.RES ERJ2GJEJ 102 X (1K)	T	115.3/10.5
R1030	7030005050	S.RES ERJ2GJEJ 103 X (10K)	T	114.4/10.5
R1031	7030005050	S.RES ERJ2GJEJ 103 X (10K)	B	117.8/7.7
R1032	7030005050	S.RES ERJ2GJEJ 103 X (10K)	B	127.1/19.9
R1033	7030000480	S.RES MCR10EZHJ 6.8K (682)	B	129.4/45.2
R1034	7030005040	S.RES ERJ2GJEJ 472 X (4.7K)	B	123.6/17.5
R1035	7030005050	S.RES ERJ2GJEJ 103 X (10K)	T	107.8/42.5
R1036	7030005040	S.RES ERJ2GJEJ 472 X (4.7K)	T	107.8/41.2
R1037	7030005090	S.RES ERJ2GJEJ 104 X (100K)	T	95.9/13.5
R1038	7030005120	S.RES ERJ2GJEJ 102 X (1K)	B	125.6/36.3
R1039	7030005090	S.RES ERJ2GJEJ 104 X (100K)	B	113.7/12.9
R1040	7030005160	S.RES ERJ2GJEJ 105 X (1M)	T	111.2/19.9
R1043	7030005160	S.RES ERJ2GJEJ 105 X (1M)	B	112.0/11.0
R1044	7030005090	S.RES ERJ2GJEJ 104 X (100K)	B	117.9/9.9
R1045	7030005050	S.RES ERJ2GJEJ 103 X (10K)	B	120.4/17.1
R1046	7030005800	S.RES RR0510P-102-D (1K)	B	119.7/9.0
R1047	7030005050	S.RES ERJ2GJEJ 103 X (10K)	B	119.4/18.6
R1048	7030009710	S.RES ERJ2GJEJ 203 X (20K)	B	119.0/22.4
R1049	7030005040	S.RES ERJ2GJEJ 472 X (4.7K)	B	116.7/19.7
R1050	7030007290	S.RES ERJ2GJEJ 222 X (2.2K)	B	123.0/38.1
R1054	7030008270	S.RES RR0510P-104-D (100K)	B	119.7/9.9
R1055	7030005090	S.RES ERJ2GJEJ 104 X (100K)	B	120.4/15.2
R1056	7030008270	S.RES RR0510P-104-D (100K)	B	118.8/10.8
R1057	7030005100	S.RES ERJ2GJEJ 154 X (15K)	B	118.8/15.2
R1059	7410001130	S.ARR EXB28V102JX	T	69.7/14.8
R1060	7410001130	S.ARR EXB28V102JX	T	63.4/11.8
R1062	7030008270	S.RES RR0510P-104-D (100K)	B	116.0/14.8
R1063	7030007340	S.RES ERJ2GJEJ 153 X (15K)	B	42.8/22.4
R1064	7030005090	S.RES ERJ2GJEJ 104 X (100K)	T	40.5/23.1
R1068	7030005120	S.RES ERJ2GJEJ 102 X (1K)	T	74.3/14.1
R1069	7030005120	S.RES ERJ2GJEJ 102 X (1K)	T	72.6/14.1
R1070	7030005120	S.RES ERJ2GJEJ 102 X (1K)	T	57.3/15.1
R1071	7030005090	S.RES ERJ2GJEJ 104 X (100K)	T	51.7/16.7
R1072	7030005040	S.RES ERJ2GJEJ 472 X (4.7K)	T	52.9/16.3
R1073	7030005700	S.RES ERJ2GJEJ 274 X (270K)	B	50.8/18.7
R1074	7030005100	S.RES ERJ2GJEJ 154 X (15K)	T	32.7/20.6
R1075	7030008010	S.RES ERJ2GJEJ 123 X (12K)	T	36.3/21.5
R1076	7030005090	S.RES ERJ2GJEJ 104 X (100K)	B	35.0/20.5
R1077	7030005170	S.RES ERJ2GJEJ 474 X (470K)	B	36.6/20.2
R1078	7030005090	S.RES ERJ2GJEJ 104 X (100K)	B	32.2/15.2
R1080	7030005310	S.RES ERJ2GJEJ 124 X (120K)	B	40.1/13.5
R1081	7030008290	S.RES ERJ2GJEJ 183 X (18K)	T	42.5/19.5
R1082	7410001130	S.ARR EXB28V102JX	T	56.9/7.6
R1083</				

[MAIN-C UNIT] (For [350 MHz band] versions)

REF NO.	PARTS NO.	DESCRIPTION	M.	H/V LOCATION
R2004	7030005210	S.RES ERJ2GEJ 822 X (8.2K)	B	12.6/8.8
R2005	7030005210	S.RES ERJ2GEJ 822 X (8.2K)	B	15.8/6.8
R2009	7030007290	S.RES ERJ2GEJ 222 X (2.2K)	B	10.5/11.7
R2010	7030004980	S.RES ERJ2GEJ 101 X (100)	T	11.5/11.7
R2011	7030004980	S.RES ERJ2GEJ 101 X (100)	T	23.0/10.4
R2012	7030004980	S.RES ERJ2GEJ 101 X (100)	T	22.5/11.3
R2013	7030005240	S.RES ERJ2GEJ 473 X (47K)	B	19.8/12.0
R2015	7030005240	S.RES ERJ2GEJ 473 X (47K)	T	18.4/11.6
R2016	7030010040	S.RES ERJ2GEJ-JPW	B	24.0/5.8
R2019	7030010040	S.RES ERJ2GEJ-JPW	B	9.9/17.9
R2020	7030010040	S.RES ERJ2GEJ-JPW	B	14.4/11.1
R2021	7030004980	S.RES ERJ2GEJ 101 X (100)	B	23.6/12.1
R2022	7030004980	S.RES ERJ2GEJ 101 X (100)	B	27.9/24.7
R2024	7030005240	S.RES ERJ2GEJ 473 X (47K)	B	26.6/21.6
R2026	7030004970	S.RES ERJ2GEJ 470 X (47)	B	27.9/22.9
R2028	7030005240	S.RES ERJ2GEJ 473 X (47K)	B	12.1/19.3
R2030	7030005240	S.RES ERJ2GEJ 473 X (47K)	B	11.0/21.2
R2031	7030005240	S.RES ERJ2GEJ 473 X (47K)	B	10.7/29.4
R2032	7030005240	S.RES ERJ2GEJ 473 X (47K)	B	24.9/17.4
R2034	7030005240	S.RES ERJ2GEJ 473 X (47K)	B	28.8/10.5
R2035	7030005240	S.RES ERJ2GEJ 473 X (47K)	B	26.7/14.9
R2036	7030004980	S.RES ERJ2GEJ 101 X (100)	T	26.8/11.9
R2037	7030007290	S.RES ERJ2GEJ 222 X (2.2K)	T	28.1/10.7
R2038	7030004970	S.RES ERJ2GEJ 470 X (47)	B	28.8/12.1
R2039	7030005240	S.RES ERJ2GEJ 473 X (47K)	B	24.1/9.5
R2040	7030005240	S.RES ERJ2GEJ 473 X (47K)	B	24.5/12.1
R2043	7410001140	S.ARR EXB28V104JX	T	15.6/26.7
R2044	7410001140	S.ARR EXB28V104JX	B	20.8/26.3
R2045	7410001140	S.ARR EXB28V104JX	T	27.0/22.6
R2046	7410001140	S.ARR EXB28V104JX	T	19.3/26.7
R2047	7410001140	S.ARR EXB28V104JX	B	10.9/14.5
R2048	7030005090	S.RES ERJ2GEJ 104 X (100K)	T	25.7/14.6
R2049	7030005090	S.RES ERJ2GEJ 104 X (100K)	B	21.8/15.6
R2050	7410001140	S.ARR EXB28V104JX	B	22.6/18.2
R2051	7410001140	S.ARR EXB28V104JX	T	9.9/17.6
R2052	7030005090	S.RES ERJ2GEJ 104 X (100K)	T	16.8/11.6
R2053	7030005090	S.RES ERJ2GEJ 104 X (100K)	T	16.0/14.5
R2056	7030010040	S.RES ERJ2GEJ-JPW	B	10.6/20.0
R2057	7030005090	S.RES ERJ2GEJ 104 X (100K)	T	10.4/22.9
R2058	7410001140	S.ARR EXB28V104JX	B	17.0/18.6
R2059	7030005090	S.RES ERJ2GEJ 104 X (100K)	T	10.4/23.8
R2060	7030005090	S.RES ERJ2GEJ 104 X (100K)	T	25.7/15.6
R2061	7030005090	S.RES ERJ2GEJ 104 X (100K)	B	14.7/12.6
R2062	7030005090	S.RES ERJ2GEJ 104 X (100K)	B	17.7/14.4
R2063	7030005090	S.RES ERJ2GEJ 104 X (100K)	B	22.1/23.4
R2064	7030005090	S.RES ERJ2GEJ 104 X (100K)	B	19.7/17.7
R2065	7030005030	S.RES ERJ2GEJ 152 X (1.5K)	B	13.8/6.8
R2066	7410001170	S.ARR EXB28V470JX	T	21.3/6.7
R2067	7030010040	S.RES ERJ2GEJ-JPW	T	11.4/5.3
R2068	7030010040	S.RES ERJ2GEJ-JPW	T	20.9/10.4
R2071	7030010040	S.RES ERJ2GEJ-JPW	T	24.9/5.7
R2072	7030005050	S.RES ERJ2GEJ 103 X (10K)	B	12.2/10.1
R2074	7030010040	S.RES ERJ2GEJ-JPW	T	8.7/10.0
R2084	7030010040	S.RES ERJ2GEJ-JPW	T	30.7/10.5
R2085	7030010040	S.RES ERJ2GEJ-JPW	B	19.5/9.6
C1	4030011080	S.CER GRM31M2C2H6R0DV01L (GRM42-6 CH)	B	8.4/66.6
C2	4030011080	S.CER GRM31M2C2H6R0DV01L (GRM42-6 CH)	B	7.4/58.6
C3	4030009500	S.CER C1608 CH 1H 0R5B-T	B	25.6/51.9
C4	4030009500	S.CER C1608 CH 1H 0R5B-T	B	16.4/51.9
C5	4030009500	S.CER C1608 CH 1H 0R5B-T	B	8.2/54.5
C6	4030011100	S.CER GRM31M2C2H8R0DV01L (GRM42-6 CH)	B	7.4/56.3
C7	4030011110	S.CER GRM31M2C2H9R0DV01L (GRM42-6 CH)	B	13.1/60.7
C8	4030011100	S.CER GRM31M2C2H8R0DV01L (GRM42-6 CH)	B	19.5/60.7
C9	4030011100	S.CER GRM31M2C2H8R0DV01L (GRM42-6 CH)	T	30.6/53.1
C10	4030017730	S.CER C1005 JB 1H 471K-T	B	18.1/48.1
C11	4030017730	S.CER C1005 JB 1H 471K-T	B	10.0/49.2
C12	4030017730	S.CER C1005 JB 1H 471K-T	T	39.4/54.4
C13	4030017420	S.CER C1005 CH 1H 470J-T	B	49.5/51.4
C14	4030019420	S.CER GRM31A7U2J102JW31D	B	34.9/55.5
C15	4030017360	S.CER C1005 CH 1H 030B-T	T	23.7/50.4
C20	4030017670	S.CER C1005 CH 1H 390J-T	B	30.6/40.5
C21	4030017580	S.CER C1005 CH 1H 060C-T	B	26.7/38.1
C22	4030017560	S.CER C1005 CH 1H 2R5B-T	B	32.0/37.5
C25	4030017420	S.CER C1005 CH 1H 470J-T	B	25.8/38.1
C26	4030017670	S.CER C1005 CH 1H 390J-T	B	33.4/40.5
C27	4030016930	S.CER C1005 JB 1A 104K-T	B	31.5/38.8
C28	4030017460	S.CER C1005 JB 1H 102K-T	B	42.5/36.2
C29	4030017600	S.CER C1005 CH 1H 080C-T	B	37.1/37.4
C30	4030017630	S.CER C1005 CH 1H 120J-T	B	39.2/37.7
C31	4030016930	S.CER C1005 JB 1A 104K-T	B	51.5/37.4
C32	4030017460	S.CER C1005 JB 1H 102K-T	B	41.3/40.7
C33	4030017420	S.CER C1005 CH 1H 470J-T	B	38.6/40.7
C34	4030017460	S.CER C1005 JB 1H 102K-T	B	37.7/40.7
C36	4030017460	S.CER C1005 JB 1H 102K-T	B	51.5/41.2
C37	4030017730	S.CER C1005 JB 1H 471K-T	B	49.0/42.7
C38	4030017460	S.CER C1005 JB 1H 102K-T	B	39.2/35.9
C39	4030017640	S.CER C1005 CH 1H 150J-T	B	52.8/40.2
C40	4030017540	S.CER C1005 CH 1H R75B-T	B	54.1/39.2
C41	4030017410	S.CER C1005 CH 1H 240J-T	B	66.9/39.2
C42	4030017460	S.CER C1005 JB 1H 102K-T	B	54.0/37.8
C43	4030016930	S.CER C1005 JB 1A 104K-T	B	54.1/38.3
C44	4030017580	S.CER C1005 CH 1H 060C-T	B	59.9/40.5
C45	4030017640	S.CER C1005 CH 1H 150J-T	B	55.5/42.0
C48	4030017420	S.CER C1005 CH 1H 470J-T	B	72.2/40.6
C49	4030017380	S.CER C1005 CH 1H 050B-T	B	75.9/39.2
C50	4030017460	S.CER C1005 JB 1H 102K-T	B	73.1/40.6
C51	4030017460	S.CER C1005 JB 1H 102K-T	T	72.4/41.1

[MAIN-C UNIT] (For [350 MHz band] versions)

REF NO.	PARTS NO.	DESCRIPTION	M.	H/V LOCATION
C52	4030017620	S.CER C1005 CH 1H 100C-T	B	70.4/41.2
C53	4030016790	S.CER C1005 JB 1E 103K-T	B	71.3/42.8
C54	4030017730	S.CER C1005 JB 1H 471K-T	B	70.4/42.8
C57	4030017460	S.CER C1005 JB 1H 102K-T	B	74.6/36.7
C58	4030017460	S.CER C1005 JB 1H 102K-T	T	67.2/26.1
C59	4030017460	S.CER C1005 JB 1H 102K-T	T	66.9/22.7
C60	4030016790	S.CER C1005 JB 1E 103K-T	T	65.3/26.6
C61	4030017430	S.CER C1005 CH 1H 101J-T	T	61.6/23.1
C62	4030017420	S.CER C1005 CH 1H 470J-T	B	57.1/24.3
C63	4030017420	S.CER C1005 CH 1H 470J-T	T	60.3/14.3
C64	4030016790	S.CER C1005 JB 1E 103K-T	B	56.2/26.8
C65	4030018860	S.CER C1005 JB 0J 105K-T	T	58.2/19.6
C66	4030017460	S.CER C1005 JB 1H 102K-T	T	54.7/19.9
C67	4030017460	S.CER C1005 JB 1H 102K-T	B	58.4/21.3
C68	4030017680	S.CER C1005 CH 1H 820J-T	T	52.2/23.8
C69	4030017710	S.CER C1005 CH 1H 181J-T	T	54.0/23.8
C70	4030017710	S.CER C1005 CH 1H 181J-T	T	54.0/25.6
C71	4030016930	S.CER C1005 JB 1A 104K-T	T	57.4/29.0
C72	4030017730	S.CER C1005 JB 1H 471K-T	T	59.8/48.0
C74	4030017730	S.CER C1005 JB 1H 471K-T	B	11.2/50.5
C75	4030019560	S.CER GRM21BB31C106KE15L	T	61.6/25.3
C76	4030016790	S.CER C1005 JB 1E 103K-T	T	57.8/54.9
C77	4030017460	S.CER C1005 JB 1H 102K-T	T	56.8/50.7
C78	4030017730	S.CER C1005 JB 1H 471K-T	B	58.8/56.6
C79	4030016960	S.CER C1005 JB 1E 183K-T	T	62.4/55.0
C81	4030017460	S.CER C1005 JB 1H 102K-T	T	65.1/55.0
C82	4030011030	S.CER GRM31M4C2H1R5CY21L (GRM42-6 CK)	T	34.9/65.2
C84	4030017420	S.CER C1005 CH 1H 470J-T	T	55.0/61.6
C85	4030017460	S.CER C1005 JB 1H 102K-T	T	56.0/61.6
C86	4030017710	S.CER C1005 CH 1H 181J-T	T	81.3/63.8
C87	4030017460	S.CER C1005 JB 1H 102K-T	T	79.8/68.8
C88	4030017730	S.CER C1005 JB 1H 471K-T	T	64.6/52.1
C89	4030017600	S.CER C1005 CH 1H 080C-T	B	87.3/57.5
C90	4030017600	S.CER C1005 CH 1H 080C-T	B	88.2/57.5
C92	4030017570	S.CER C1005 CH 1H 040B-T	B	89.9/58.0
C93	4030017630	S.CER C1005 CH 1H 120J-T	B	86.9/51.6
C96	4030017460	S.CER C1005 JB 1H 102K-T	B	87.8/56.3
C97	4030017730	S.CER C1005 JB 1H 471K-T	B	87.8/55.4
C98	4030017730	S.CER C1005 CH 1H 050B-T	B	83.5/48.7
C99	4030017380	S.CER C1005 JB 1H 471K-T	B	81.4/48.3
C100	4030017600	S.CER C1005 CH 1H 080C-T	B	91.2/34.9
C102	4030017580	S.CER C1005 CH 1H 060C-T	B	97.1/33.8
C103	4030017360	S.CER C1005 CH 1H 030B-T	B	98.5/32.2
C104	4030017460	S.CER C1005 JB 1H 102K-T	B	100.8/29.9
C105	4030017730	S.CER C1005 JB 1H 471K-T	B	97.6/28.9
C106	4030017420	S.CER C1005 CH 1H 470J-T	B	91.7/48.9
C107	4030017460	S.CER C1005 JB 1H 102K-T	T	80.2/51.7
C108	4030016790	S.CER C1005 JB 1E 103K-T	B	81.3/49.2
C109	4030017460	S.CER C1005 JB 1H 102K-T	B	95.8/35.3
C110	4030017730	S.CER C1005 JB 1H 471K-T	B	98.6/35.3
C111	4030017730	S.CER C1005 JB 1H 471K-T	T	101.7/37.1
C112	4030016930	S.CER C1005 JB 1A 104K-T	T	100.8/37.1
C113	4030017520	S.CER C1005 CH 1H 0R3B-T	B	102.0/29.6
C114	4030017610	S.CER C1005 CH 1H 090C-T	B	98.3/26.1
C115	4030017400	S.CER C1005 CH 1H 220J-T	B	98.8/21.9
C116	4030017460	S.CER C1005 JB 1H 102K-T	B	107.5/30.0
C117	4030017730	S.CER C1005 JB 1H 471K-T	B	107.5/30.9
C118	4030017520	S.CER C1005 CH 1H 0R3B-T	B	102.8/32.0
C119	4030016790	S.CER C1005 JB 1E 103K-T	B	97.0/21.9
C120	4030017730	S.CER C1005 JB 1H 471K-T	B	97.9/21.9
C121	4030017590	S.CER C1005 CH 1H 070C-T	B	103.3/30.8
C122	4030017390	S.CER C1005 CH 1H 180J-T	B	107.5/31.8
C123	4030017670	S.CER C1005 CH 1H 390J-T	B	104.8/28.2
C124	4030017660	S.CER C1005 CH 1H 330J-T	B	105.0/20.8
C125	4030017420	S.CER C1005 CH 1H 470J-T	B	101.7/27.5
C126	4030018070	S.CER C1005 CH 1H 300J-T	B	95.6/23.7
C127	4030017660	S.CER C1005 CH 1H 330J-T	B	96.1/21.9
C128	4030017360	S.CER C1005 CH 1H 030B-T	B	99.2/27.3
C129	4030017530	S.CER C1005 CH 1H 0R5B-T	B	103.5/27.5
C131	4030017600	S.CER C1005 CH 1H 080C-T	B	106.4/27.2
C132	4030017460	S.CER C1005 JB 1H 102K-T	T	94.3/12.6
C133	4030017640	S.CER C1005 CH 1H 150J-T	B	105.4/22.8
C134	4030017390	S.CER C1005 CH 1H 180J-T	B	93.7/22.7
C135	4030016790	S.CER C1005 JB 1E 103K-T	T	78.3/21.0
C136	4030017370	S.CER C1005 CH 1H 3R5B-T	B	95.2/20.1
C139	4030016930	S.CER C1005 JB 1A 104K-T	B	107.5/33.6
C140	4030017430	S.CER C1005 CH 1H 101J-T	B	81.2/18.9
C141	4030017460	S.CER C1005 JB 1H 102K-T	T	75.7/21.5
C143	4030017460	S.CER C1005 JB 1H 102K-T	T	78.9/22.2
C144	4030017420	S.CER C1005 CH 1H 470J-T	T	92.5/16.1
C146				

[MAIN-C UNIT] (For [350 MHz band] versions)

REF NO.	PARTS NO.	DESCRIPTION	M.	H/V LOCATION
C299	4030017580	S.CER C1005 CH 1H 060C-T	T	83.9/29.4
C300	4030017560	S.CER C1005 CH 1H 2R5B-T	T	85.1/30.8
C301	4030017730	S.CER C1005 JB 1H 471K-T	B	92.8/31.3
C302	4030017420	S.CER C1005 CH 1H 470J-T	B	80.1/39.2
C303	4030017730	S.CER C1005 JB 1H 471K-T	B	80.1/36.3
C305	4030017500	S.CER C1005 CH 1H 560J-T	B	64.8/24.2
C306	4030017580	S.CER C1005 CH 1H 060C-T	B	64.3/25.4
C307	4030017500	S.CER C1005 CH 1H 560J-T	B	61.3/22.7
C308	4030017360	S.CER C1005 CH 1H 030B-T	B	60.1/23.2
C309	4030016790	S.CER C1005 JB 1E 103K-T	B	67.4/21.8
C312	4030016930	S.CER C1005 JB 1A 104K-T	B	67.4/20.9
C314	4030016790	S.CER C1005 JB 1E 103K-T	T	110.5/33.8
C323	4030017620	S.CER C1005 CH 1H 100C-T	B	72.3/26.2
C328	4030017340	S.CER C1005 CH 1H 010B-T	B	85.4/55.8
C332	4030017530	S.CER C1005 CH 1H 0R5B-T	B	84.9/50.0
C333	4030017420	S.CER C1005 CH 1H 470J-T	B	40.4/40.7
C334	4030017590	S.CER C1005 CH 1H 070C-T	B	94.9/68.3
C335	4030017630	S.CER C1005 CH 1H 120J-T	B	93.8/68.3
C336	4030017710	S.CER C1005 CH 1H 181J-T	B	62.0/68.7
C337	4030017460	S.CER C1005 JB 1H 102K-T	T	82.7/29.2
C340	4030017710	S.CER C1005 CH 1H 181J-T	B	107.7/28.7
C342	4550002980	S.TAN TEESVA 1C 225M8R	T	78.4/66.1
C343	4030017460	S.CER C1005 JB 1H 102K-T	B	51.5/39.2
C344	4030017460	S.CER C1005 JB 1H 102K-T	B	54.2/68.0
C345	4030017730	S.CER C1005 JB 1H 471K-T	B	54.2/67.1
C346	4030017420	S.CER C1005 CH 1H 470J-T	B	66.0/68.7
C347	4030017460	S.CER C1005 JB 1H 102K-T	T	52.2/22.9
C348	4030017460	S.CER C1005 JB 1H 102K-T	T	59.3/20.5
C350	4030017920	S.CER C1005 JB 1A 683K-T	T	95.9/14.4
C357	4030016930	S.CER C1005 JB 1A 104K-T	T	103.5/34.7
C358	4030017340	S.CER C1005 CH 1H 010B-T	B	91.2/35.8
C366	4030017460	S.CER C1005 JB 1H 102K-T	B	97.0/64.4
C367	4030017730	S.CER C1005 JB 1H 471K-T	B	97.0/65.8
C368	4030017420	S.CER C1005 CH 1H 470J-T	B	97.0/67.3
C372	4030017730	S.CER C1005 JB 1H 471K-T	T	60.3/67.7
C376	4030017730	S.CER C1005 JB 1H 471K-T	B	88.7/49.5
C377	4030017460	S.CER C1005 JB 1H 102K-T	T	57.8/61.6
C383	4030018860	S.CER C1005 JB 0J 105K-T	T	36.4/36.2
C384	4030016930	S.CER C1005 JB 1A 104K-T	T	59.3/29.0
C385	4030016930	S.CER C1005 JB 1A 104K-T	B	54.9/28.9
C388	4030017730	S.CER C1005 JB 1H 471K-T	B	68.2/36.7
C390	4030017460	S.CER C1005 JB 1H 102K-T	B	75.0/40.6
C391	4030017420	S.CER C1005 CH 1H 470J-T	B	75.9/40.6
C392	4030017540	S.CER C1005 CH 1H R75B-T	B	60.3/39.2
C393	4030017570	S.CER C1005 CH 1H 040B-T	B	66.3/40.5
C394	4030016930	S.CER C1005 JB 1A 104K-T	B	50.9/28.8
C395	4030016930	S.CER C1005 JB 1A 104K-T	B	45.1/29.0
C396	4030016930	S.CER C1005 JB 1A 104K-T	T	55.8/29.0
C397	4030016790	S.CER C1005 JB 1E 103K-T	B	50.4/12.7
C398	4030016790	S.CER C1005 JB 1E 103K-T	B	48.6/27.3
C399	4030016790	S.CER C1005 JB 1E 103K-T	B	48.3/28.5
C400	4030017710	S.CER C1005 CH 1H 181J-T	T	81.2/37.6
C401	4030017580	S.CER C1005 CH 1H 060C-T	B	78.6/40.6
C402	4030011070	S.CER GRM31M2C2H5R0CY21L (GRM42-6 CH)	B	38.0/68.7
C403	4030011070	S.CER GRM31M2C2H5R0CY21L (GRM42-6 CH)	B	34.9/65.2
C404	4030011110	S.CER GRM31M2C2H9R0DV01L (GRM42-6 CH)	B	15.5/60.7
C408	4030017730	S.CER C1005 JB 1H 471K-T	B	23.9/48.1
C409	4030017460	S.CER C1005 JB 1H 102K-T	B	39.3/51.1
C411	4030017460	S.CER C1005 JB 1H 102K-T	T	42.2/55.4
C413	4030018860	S.CER C1005 JB 0J 105K-T	B	91.5/25.3
C416	4030017420	S.CER C1005 CH 1H 470J-T	B	93.4/25.3
C418	4030018890	S.CER C1005 JB 0J 224K-T	T	102.8/17.3
C420	4030011110	S.CER GRM31M2C2H9R0DV01L (GRM42-6 CH)	B	21.7/60.7
C421	4030011080	S.CER GRM31M2C2H6R0DV01L (GRM42-6 CH)	B	28.2/60.7
C423	4030017570	S.CER C1005 CH 1H 040B-T	B	77.7/40.6
C429	4030017640	S.CER C1005 CH 1H 150J-T	B	61.9/42.0
C447	4030017730	S.CER C1005 JB 1H 471K-T	B	83.3/52.0
C448	4030017670	S.CER C1005 CH 1H 390J-T	B	87.8/49.5
C453	4030017420	S.CER C1005 CH 1H 470J-T	B	101.3/35.3
C454	4030017460	S.CER C1005 JB 1H 102K-T	B	100.4/35.3
C457	4030017420	S.CER C1005 CH 1H 470J-T	B	54.0/37.4
C458	4030017420	S.CER C1005 CH 1H 470J-T	T	63.8/50.8
C459	4030017420	S.CER C1005 CH 1H 470J-T	B	61.1/48.4
C460	4030017420	S.CER C1005 CH 1H 470J-T	T	84.9/49.8
C463	4030017720	S.CER C1005 JB 1H 331K-T	T	54.0/26.5
C466	4030017420	S.CER C1005 CH 1H 470J-T	T	62.7/49.8
C467	4030017420	S.CER C1005 CH 1H 470J-T	T	88.4/10.4
C471	4030017420	S.CER C1005 CH 1H 470J-T	B	103.7/19.2
C494	4030018860	S.CER C1005 JB 0J 105K-T	T	37.3/36.2
C624	4030017460	S.CER C1005 JB 1H 102K-T	B	81.2/26.7
C625	4030019990	S.CER C1005 JB 1C 104K-T	B	63.3/16.4
C626	4030017430	S.CER C1005 CH 1H 101J-T	B	59.9/20.5
C627	4030018910	S.CER C1608 JB 0J 475K-T	B	57.7/19.6
C628	4030017590	S.CER C1005 CH 1H 070C-T	T	63.3/36.2
C629	4030017530	S.CER C1005 CH 1H 0R5B-T	T	66.8/29.7
C630	4030016790	S.CER C1005 JB 1E 103K-T	T	68.6/28.8
C631	4030016790	S.CER C1005 JB 1E 103K-T	T	68.6/41.6
C632	4030016790	S.CER C1005 JB 1E 103K-T	T	76.5/41.6
C633	4030016930	S.CER C1005 JB 1A 104K-T	T	81.3/43.1
C634	4030016930	S.CER C1005 JB 1A 104K-T	T	80.0/41.2
C635	4030016790	S.CER C1005 JB 1E 103K-T	T	71.5/29.7
C637	4030017600	S.CER C1005 CH 1H 080C-T	T	72.3/36.2
C638	4030017460	S.CER C1005 JB 1H 102K-T	T	83.5/42.2
C639	4030016930	S.CER C1005 JB 1A 104K-T	T	46.8/25.7
C640	4030017040	S.CER C1005 JB 1A 333K-T	B	38.8/24.4
C641	4030018890	S.CER C1005 JB 0J 224K-T	B	76.3/27.1
C642	4030018890	S.CER C1005 JB 0J 224K-T	B	77.5/27.0
C643	4030017430	S.CER C1005 CH 1H 101J-T	B	77.5/27.9
C644	4030019560	S.CER GRM21BB31C106KE15L	B	81.7/20.4
C645	4030016930	S.CER C1005 JB 1A 104K-T	B	30.0/15.7

[MAIN-C UNIT] (For [350 MHz band] versions)

REF NO.	PARTS NO.	DESCRIPTION	M.	H/V LOCATION
C646	4030017460	S.CER C1005 JB 1H 102K-T	T	84.7/10.0
C647	4030016790	S.CER C1005 JB 1E 103K-T	B	59.1/27.7
C1003	4030017460	S.CER C1005 JB 1H 102K-T	B	133.3/63.5
C1005	4030018980	S.CER C1608 JB 1H 104K-T	B	100.1/11.8
C1007	4030017460	S.CER C1005 JB 1H 102K-T	T	100.1/12.1
C1008	4510009680	S.ELE EEEFK1E471P	B	110.2/52.6
C1010	4030017460	S.CER C1005 JB 1H 102K-T	B	106.5/59.0
C1011	4030016930	S.CER C1005 JB 1A 104K-T	B	93.9/12.1
C1012	4030017420	S.CER C1005 CH 1H 470J-T	B	117.5/16.6
C1014	4030017460	S.CER C1005 JB 1H 102K-T	T	116.6/27.5
C1015	4030017460	S.CER C1005 JB 1H 102K-T	T	114.9/8.0
C1017	4030017460	S.CER C1005 JB 1H 102K-T	B	122.5/64.9
C1018	4030017460	S.CER C1005 JB 1H 102K-T	T	133.3/45.0
C1019	4510009250	S.ELE EEEFK1C471P	B	130.5/34.8
C1022	4030017420	S.CER C1005 CH 1H 470J-T	B	105.5/59.0
C1023	4030017460	S.CER C1005 JB 1H 102K-T	B	113.4/58.8
C1024	4030017440	S.CER C1005 CH 1H 221J-T	B	113.4/59.7
C1025	4030017510	S.CER C1005 CH 1H 680J-T	B	113.4/60.6
C1026	4030019120	S.CER GRM188B31E105KA75D	T	115.8/49.5
C1028	4030017460	S.CER C1005 JB 1H 102K-T	B	117.4/6.1
C1029	4030017460	S.CER C1005 JB 1H 102K-T	T	114.9/12.6
C1031	4030017460	S.CER C1005 JB 1H 102K-T	T	115.0/16.9
C1032	4030016930	S.CER C1005 JB 1A 104K-T	B	123.6/16.6
C1033	4510009680	S.ELE EEEFK1E471P	B	120.0/29.1
C1034	4030018860	S.CER C1005 JB 0J 105K-T	B	131.6/16.6
C1035	4030016790	S.CER C1005 JB 1E 103K-T	B	131.6/18.7
C1036	4030018980	S.CER C1608 JB 1H 104K-T	T	128.4/46.9
C1037	4030019560	S.CER GRM21BB31C106KE15L	B	129.4/43.4
C1038	4030011600	S.CER C1608 JB 1E 104K-T	T	110.5/48.7
C1039	4510009680	S.ELE EEEFK1E471P	B	117.0/41.7
C1040	4030019560	S.CER GRM21BB31C106KE15L	B	116.7/22.2
C1042	4030016930	S.CER C1005 JB 1A 104K-T	B	118.1/22.4
C1043	4030016930	S.CER C1005 JB 1A 104K-T	T	114.9/16.0
C1045	4030017460	S.CER C1005 JB 1H 102K-T	T	114.9/14.2
C1046	4030018860	S.CER C1005 JB 0J 105K-T	T	114.9/15.1
C1048	4030018900	S.CER C1005 JB 0J 474K-T	B	126.7/18.6
C1050	4030018860	S.CER C1005 JB 0J 105K-T	B	125.2/16.6
C1051	4030017460	S.CER C1005 JB 1H 102K-T	B	122.1/48.2
C1052	4030016930	S.CER C1005 JB 1A 104K-T	T	127.8/40.1
C1053	4030019560	S.CER GRM21BB31C106KE15L	T	127.8/44.5
C1056	4030018860	S.CER C1005 JB 0J 105K-T	T	111.2/11.7
C1057	4030016930	S.CER C1005 JB 1A 104K-T	B	118.7/17.1
C1058	4030019560	S.CER GRM21BB31C106KE15L	T	105.5/44.4
C1059	4030017460	S.CER C1005 JB 1H 102K-T	T	107.7/46.3
C1060	4030017460	S.CER C1005 JB 1H 102K-T	B	126.2/39.8
C1061	4030017460	S.CER C1005 JB 1H 102K-T	T	107.7/37.4
C1062	4030017460	S.CER C1005 JB 1H 102K-T	B	120.7/22.9
C1063	4030019560	S.CER GRM21BB31C106KE15L	B	126.9/22.2
C1064	4030019560	S.CER GRM21BB31C106KE15L	B	121.6/36.0
C1065	4030017460	S.CER C1005 JB 1H 102K-T	B	120.2/35.6
C1066	4030018860	S.CER C1005 JB 0J 105K-T	B	125.6/38.1
C1070	4030017440	S.CER C1005 CH 1H 221J-T	B	120.4/16.2
C1071	4030016930	S.CER C1005 JB 1A 104K-T	B	120.4/10.8
C1074	4030017460	S.CER C1005 JB 1H 102K-T	B	73.9/10.4
C1075	4030017460	S.CER C1005 JB 1H 102K-T	B	70.7/14.4
C1076	4030017460	S.CER C1005 JB 1H 102K-T	B	69.7/14.4
C1077	4030017460	S.CER C1005 JB 1H 102K-T	B	68.8/14.4
C1080	4030016790	S.CER C1005 JB 1E 103K-T	B	51.1/15.3
C1081	4030016930	S.CER C1005 JB 1A 104K-T	B	117.2/15.2
C1082	4030016930	S.CER C1005 JB 1A 104K-T	B	114.8/16.3
C1083	4030017460	S.CER C1005 JB 1H 102K-T	T	37.6/19.3
C1084	4030017710	S.CER C1005 CH 1H 181J-T	B	41.9/20.8
C1092	4030016930	S.CER C1005 JB 1A 104K-T	B	75.8/14.4
C1095	4030016930	S.CER C1005 JB 1A 104K-T	T	38.5/19.3
C1096	4030018860	S.CER C1005 JB 0J 105K-T	T	51.7/18.5
C1097	4030018240	S.CER C1005 JB 1H 562K-T	B	50.8/17.8
C1098	4030018860	S.CER C1005 JB 0J 105K-T	T	54.5/16.3
C1099	4030018860	S.CER C1005 JB 0J 105K-T	B	45.2/20.8
C1100	4030017460	S.CER C1005 JB 1H 102K-T	B	75.8/9.1
C1101	4030016930	S.CER C1005 JB 1A 104K-T	T	78.2/8.0
C1102	4030017420	S.CER C1005 CH 1H 470J-T	B	71.6/6.6
C1106	4030016930	S.CER C1005 JB 1A 104K-T	T	36.3/20.6
C1107	4030017440	S.CER C1005 CH 1H		

[MAIN-C UNIT] (For [350 MHz band] versions)

REF NO.	PARTS NO.	DESCRIPTION	M.	H/V LOCATION
C2012	4030016930	S.CER C1005 JB 1A 104K-T	B	26.4/5.8
C2013	4550007730	S.TAN TEESVJ OJ 106M8R	B	25.0/6.2
C2014	4030016930	S.CER C1005 JB 1A 104K-T	T	31.7/6.6
C2015	4030016930	S.CER C1005 JB 1A 104K-T	B	10.1/6.4
C2016	4550007720	S.TAN TEESVP OG 476M8R	T	26.7/7.1
C2017	4550007730	S.TAN TEESVJ OJ 106M8R	B	17.2/9.2
C2018	4030016930	S.CER C1005 JB 1A 104K-T	B	9.2/6.4
C2019	4030016790	S.CER C1005 JB 1E 103K-T	B	14.8/19.3
C2021	4030018910	S.CER C1608 JB 0J 475K-T	B	16.0/21.6
C2022	4030018910	S.CER C1608 JB 0J 475K-T	B	13.5/14.5
C2023	4030016790	S.CER C1005 JB 1E 103K-T	B	23.1/14.3
C2024	4030018860	S.CER C1005 JB 0J 105K-T	B	21.2/14.1
C2025	4030017420	S.CER C1005 CH 1H 470J-T	B	20.8/11.1
C2026	4030017460	S.CER C1005 JB 1H 102K-T	B	20.8/10.2
C2027	4030018910	S.CER C1608 JB 0J 475K-T	B	10.9/10.0
C2028	4030018860	S.CER C1005 JB 0J 105K-T	T	11.5/10.2
C2031	4030018860	S.CER C1005 JB 0J 105K-T	T	20.9/11.3
C2032	4030016930	S.CER C1005 JB 1A 104K-T	T	13.1/11.7
C2033	4030018860	S.CER C1005 JB 0J 105K-T	B	15.1/17.7
C2034	4030016930	S.CER C1005 JB 1A 104K-T	T	11.9/7.9
C2035	4030018910	S.CER C1608 JB 0J 475K-T	T	10.2/8.2
C2036	4030018860	S.CER C1005 JB 0J 105K-T	B	21.1/20.9
C2038	4030016790	S.CER C1005 JB 1E 103K-T	B	16.4/25.3
C2039	4030017430	S.CER C1005 CH 1H 101J-T	B	19.7/7.5
C2040	4030016790	S.CER C1005 JB 1E 103K-T	T	26.4/18.1
C2041	4030018910	S.CER C1608 JB 0J 475K-T	T	11.1/14.5
C2042	4030016930	S.CER C1005 JB 1A 104K-T	T	10.1/14.8
C2044	4030016790	S.CER C1005 JB 1E 103K-T	T	26.4/19.9
C2045	4030016930	S.CER C1005 JB 1A 104K-T	B	26.6/23.4
C2046	4030016930	S.CER C1005 JB 1A 104K-T	B	26.6/24.3
C2047	4030016930	S.CER C1005 JB 1A 104K-T	B	26.6/20.7
C2048	4030016930	S.CER C1005 JB 1A 104K-T	B	26.6/22.5
C2049	4030017420	S.CER C1005 CH 1H 470J-T	B	25.7/9.5
C2050	4030017620	S.CER C1005 CH 1H 100C-T	B	26.7/15.8
C2051	4030016930	S.CER C1005 JB 1A 104K-T	B	13.6/29.4
C2052	4030016930	S.CER C1005 JB 1A 104K-T	B	25.5/15.3
C2053	4030017460	S.CER C1005 JB 1H 102K-T	B	27.4/10.4
C2054	4030016930	S.CER C1005 JB 1A 104K-T	T	25.5/12.4
C2055	4030017400	S.CER C1005 CH 1H 220J-T	B	11.0/20.3
C2056	4030017380	S.CER C1005 CH 1H 050B-T	T	27.2/10.7
C2057	4030016930	S.CER C1005 JB 1A 104K-T	B	24.1/10.4
C2058	4030016790	S.CER C1005 JB 1E 103K-T	B	28.8/13.7
C2059	4030017620	S.CER C1005 CH 1H 100C-T	B	18.9/6.2
C2060	4030016780	S.CER C1005 JB 1E 153K-T	B	12.2/11.7
C2062	4030018860	S.CER C1005 JB 0J 105K-T	T	9.4/20.1
C2063	4030017420	S.CER C1005 CH 1H 470J-T	T	2.1/14.7
C2064	4030017420	S.CER C1005 CH 1H 470J-T	T	2.5/13.5
C2065	4030017420	S.CER C1005 CH 1H 470J-T	T	3.8/13.0
C2066	4030017420	S.CER C1005 CH 1H 470J-T	T	6.5/16.5
C2067	4030017420	S.CER C1005 CH 1H 470J-T	T	7.5/24.0
C2068	4030017620	S.CER C1005 CH 1H 100C-T	T	19.5/5.3
C2069	4030017420	S.CER C1005 CH 1H 470J-T	T	27.5/17.2
C2070	4030016930	S.CER C1005 JB 1A 104K-T	B	21.0/12.5
C2071	4030016930	S.CER C1005 JB 1A 104K-T	B	21.7/19.7
C2072	4030016930	S.CER C1005 JB 1A 104K-T	B	17.2/23.8
C2073	4030016930	S.CER C1005 JB 1A 104K-T	B	20.2/16.0
C2074	4030017420	S.CER C1005 CH 1H 470J-T	T	13.1/5.3
C2075	4030017430	S.CER C1005 CH 1H 101J-T	B	18.3/15.9
C2076	4030016930	S.CER C1005 JB 1A 104K-T	T	7.7/27.1
C2077	4030019610	S.CER GRM155B31A105KE15D	B	41.2/6.1
C2078	4030017460	S.CER C1005 JB 1H 102K-T	B	39.8/8.9
C2079	4030017460	S.CER C1005 JB 1H 102K-T	B	38.2/8.9
C2080	4030016790	S.CER C1005 JB 1E 103K-T	B	36.7/5.4
C2081	4550007730	S.TAN TEESVJ OJ 106M8R	B	36.5/7.2
J1001	6510014961	S.CON B2B-ZR-SM4-TF(LF)(SN)	T	130.5/27.3
J1002	6450000140	CON HSJ0807-01-010		
J1003	6510022891	S.CON B13B-ZR-SM4-TF(LF)(SN)	T	120.0/17.2
J1004	6510027960	S.CON 04-6294-040-000-800	T	67.5/10.6
S1001	2260003180	S.SWI MINISMDC050F-2 CN	T	114.1/33.8
W1	7030012290	JUM RDS2T0R0		
W2	8900011863	CAB OPC-1195C <TJM>		
EP1	6910018460	S.BEA MMZ1005Y102C-T	B	107.5/32.7
EP4	6910010280	BEA HF70BB9.5X10.4X4.9		
EP5	6910010280	BEA HF70BB9.5X10.4X4.9		
EP7	6910018460	S.BEA MMZ1005Y102C-T	B	74.2/19.4
EP8	6910018460	S.BEA MMZ1005Y102C-T	B	80.8/16.7
EP13	6910018460	S.BEA MMZ1005Y102C-T	B	100.1/25.3
EP2001	6910016330	S.BEA MMZ1005S 601CT-S	B	22.8/5.3
EP2003	6910016330	S.BEA MMZ1005S 601CT-S	T	9.1/7.0
EP2004	6910016330	S.BEA MMZ1005S 601CT-S	T	32.7/9.0
EP2005	6910016330	S.BEA MMZ1005S 601CT-S	B	24.6/23.8
EP2007	6910016330	S.BEA MMZ1005S 601CT-S	T	10.8/6.2

M.=Mounted side (T: Mounted on the Top side, B: Mounted on the Bottom side)
S.=Surface mount

BOARD LAYOUTS

• FRONT UNIT (TOP VIEW)

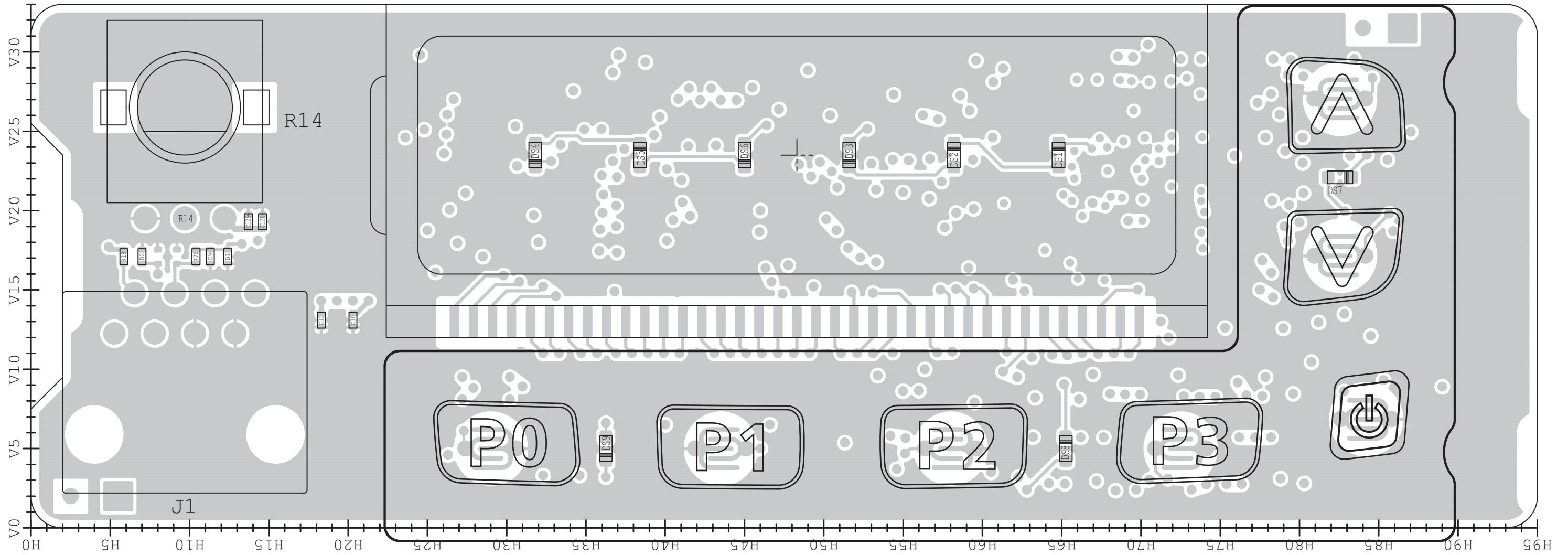

• FRONT UNIT
(BOTTOM VIEW)

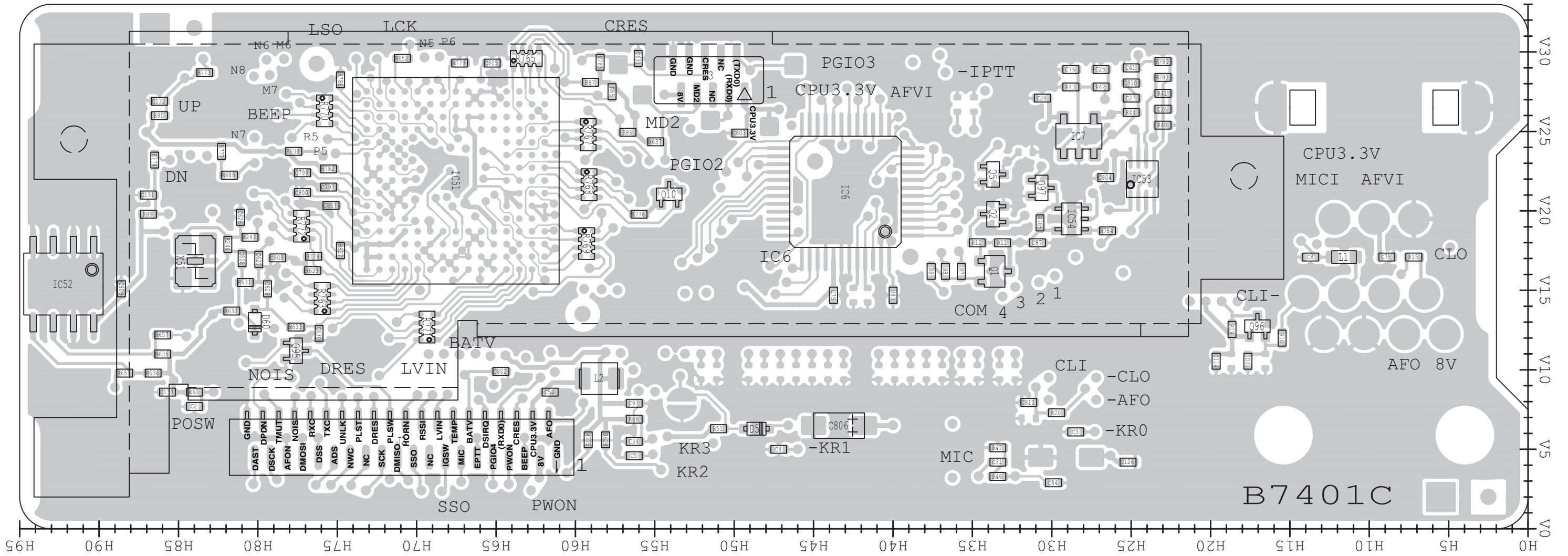

VOLTAGE DIAGRAM

• FRONT UNIT

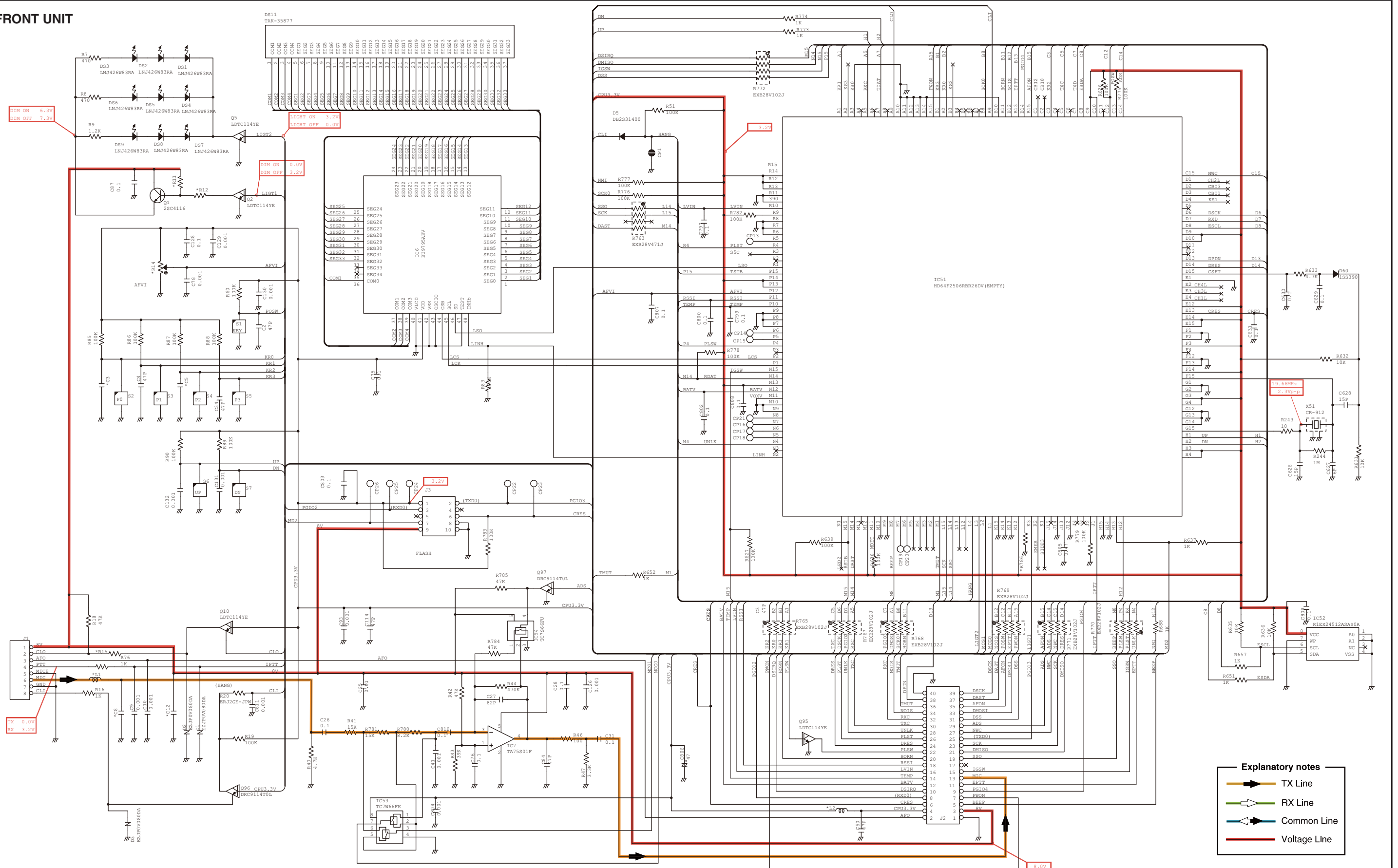

Explanatory notes

- TX Line
- RX Line
- Common Line
- Voltage Line

*: Refer to the PARTS LIST for the value and name of component.

• MAIN-A/MAIN-B/MAIN-C UNIT (1/3)

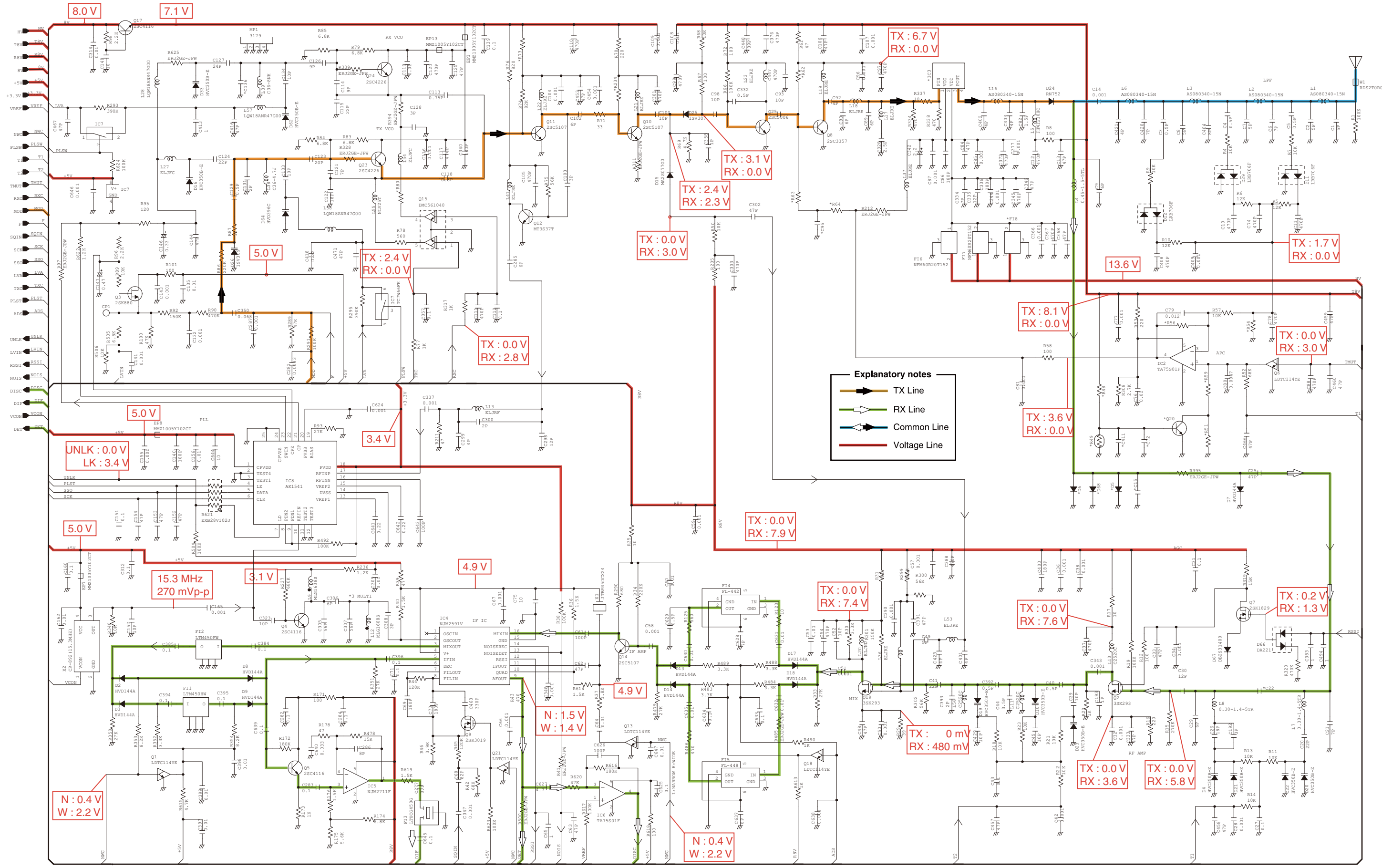

*: Refer to the PARTS LIST for the value and name of component.

• MAIN-A/MAIN-B/MAIN-C UNIT (2/3)

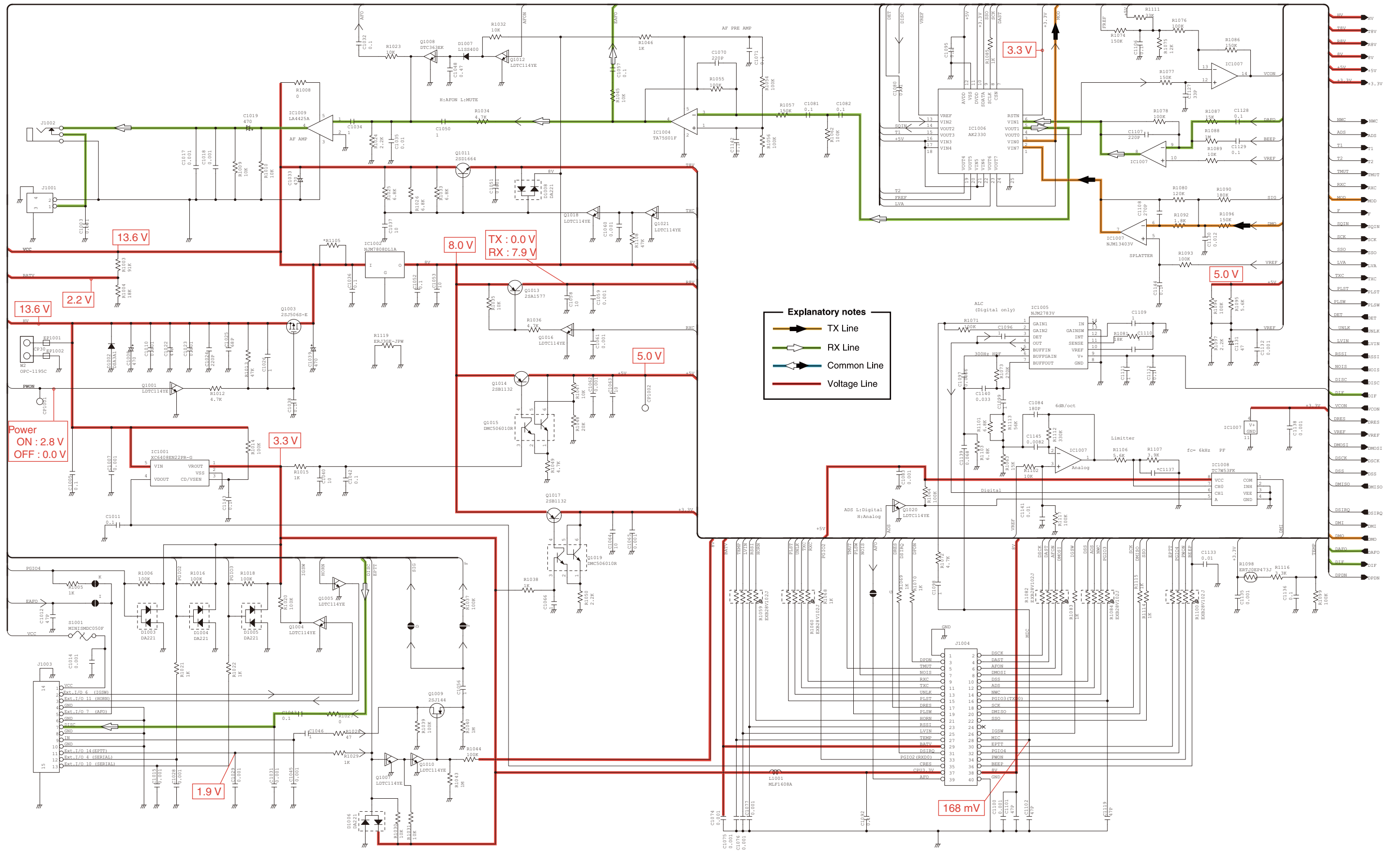

• MAIN-A/MAIN-B/MAIN-C UNIT (3/3)

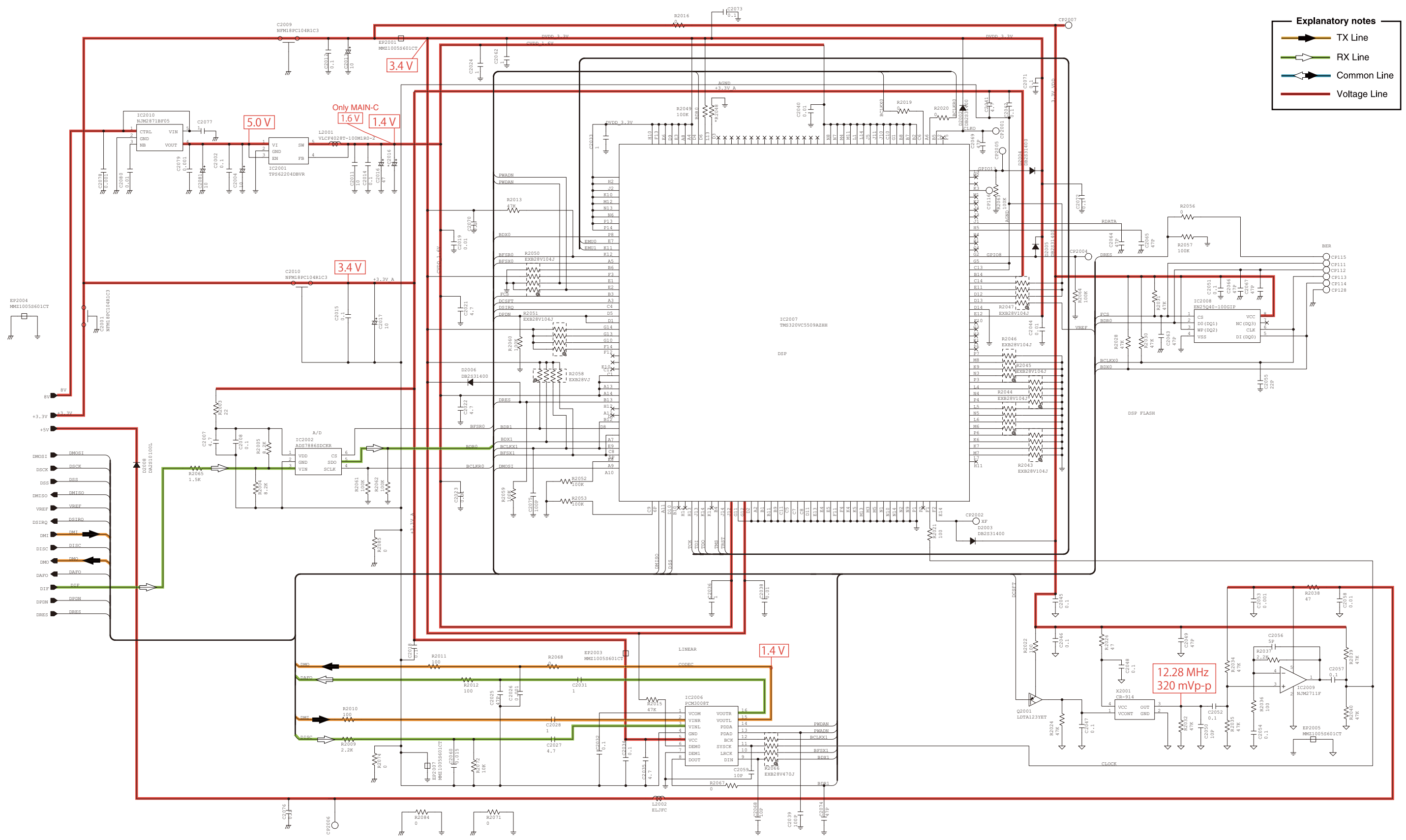
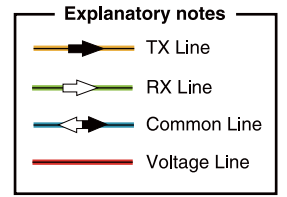

*: Refer to the PARTS LIST for the value and name of component.



SERVICE MANUAL ADDENDUM

IC-F6120D IC-F6122D IC-F6123D IC-F6128D

CONTENTS

REPLACEMENT PAGE	6-5 to 6-8
PARTS LIST	1
BOARD LAYOUTS	17
VOLTAGE DIAGRAM	19

[VERSION LIST]

MODEL	VERSION	FREQUENCY RANGE (MHz)	CHANNEL SPACING (kHz)	TX POWER
IC-F6121D	USA-01	400-470	6.25/12.5	45 W
	USA-02	450-512		
IC-F6122D	EUR-01	400-470	6.25/12.5/20.0/25.0	25 W
IC-F6123D	EXP-01	400-470	6.25/12.5/25.0	
	EXP-02	450-520		
	EXP-03	400-470		
	EXP-04	400-520		
	EXP-05	350-400		
	EXP-06	350-400		
IC-F6128D	CHN-01	400-470		45W

6-2 FREQUENCY ADJUSTMENTS

- 1) Select an adjustment item using [↑]/[↓] on the PC's keyboard.
- 2) Set or modify the adjustment value as specified using [←]/[→] on the PC's keyboard, then push [ENTER].

ADJUSTMENT	TRANSCEIVER'S CONDITION	OPERATION	ADJUSTMENT ITEM	VALUE
PLL LOCK VOLTAGE (RX)	1 • Channel : 1-1 • Receiving	• Connect an RF power meter to the antenna connector.	[RX LVA(Adjust)]	1.0 V
	2 • Channel : 1-2 • Receiving		[RX LVA(Adjust)]	3.95–4.05 V
(TX)	3 • Channel : 1-1 • Transmitting		[TX LVA(Adjust)]	1.0 V
	4 • Channel : 1-2 • Transmitting		[TX LVA(Adjust)]	3.95–4.05 V
REFERENCE FREQUENCY	1 • Channel : 1-2 • Transmitting	• Loosely couple a frequency counter to the antenna connector.	[REF]	470.000000 MHz* 520.000000 MHz** 400.000000 MHz*** (±250 Hz)

*; [Low band] versions.

**; [High band] versions.

***; [350 MHz band] versions.

• I/O Check screen

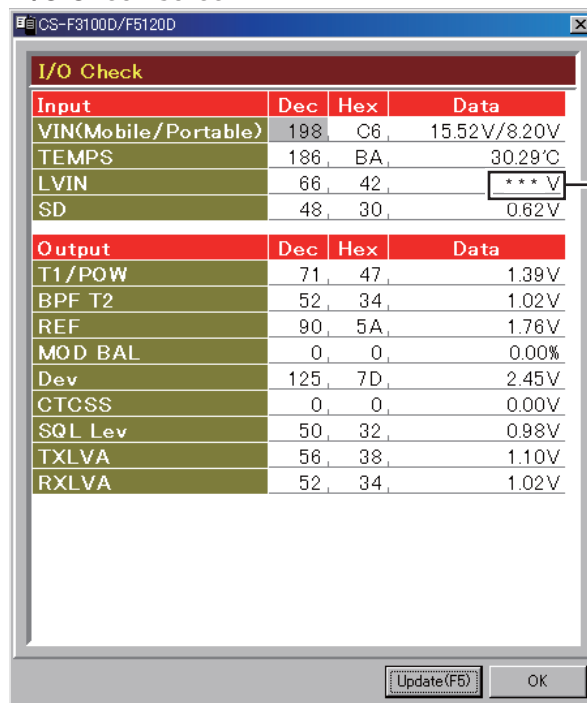

Lock voltage appears here

(The values shown above are exsample only.
Each transceiver has own values.)

6-3 TRANSMIT ADJUSTMENTS

- 1) Select an adjustment item using [↑]/[↓] on the PC's keyboard.
- 2) Set or modify the adjustment value as specified using [←]/[→] on the PC's keyboard, then push [ENTER].

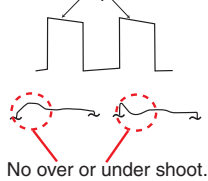
ADJUSTMENT	TRANSCEIVER'S CONDITION	OPERATION	ADJUSTMENT ITEM	VALUE	
TX OUTPUT POWER (Hi power)	1 • Channel : 1-3 • Transmitting	• Connect an RF power meter to the antenna connector.	[Power (Hi)]	45 W [45 W ver.] 25 W [25 W ver.]	
(L2 power)	2 • Channel : 1-4 • Transmitting		[Power (L2)]	25 W [45 W ver.] 10 W [25 W ver.]	
(L1 power)	3 • Channel : 1-5 • Transmitting		[Power (L1)]	4.5 W [45 W ver.] 2.5 W [25 W ver.]	
MODULATION BALANCE -Band low-	1	• Set [MOD(NARROW)] to "150" on the "Adjust Utility" screen.	[MOD(NARROW)]	150	
	2	• Set [TX MODE] to "2 (Analog 100Hz Pulse)" on the "Adjust Utility" screen.	[TX MODE]	2 (Analog 100Hz Pulse)	
	3	• Push [ENTER] on the PC's keyboard, to enter the modulation balance adjustment mode.	[BAL Start]	—	
	4	• Channel : 1-6 • Transmitting	• Connect a modulation analyzer with an oscilloscope to the antenna connector, through an attenuator, and then set it as; HPF : OFF LPF : 20 kHz De-emphasis : OFF Detector : (P-P)/2	[BAL 1]	Square waveform As flat as possible. 
	-Band center-	5 • Channel : 1-7 • Transmitting		[BAL 2]	
	-Band high-	6 • Channel : 1-8 • Transmitting		[BAL 3]	
		7	• Push [ENTER] on the PC's keyboard, to store the value and quit the modulation balance adjustment mode.	[BAL Start]	—
FM DEVIATION (Narrow mode) -Band low-	1	• Push [ENTER] on the PC's keyboard, to enter the FM deviation (For narrow mode) adjustment mode.	[MOD N Start]	—	
	2	• Channel : 1-9 • Transmitting	• Connect a modulation analyzer to the antenna connector, through an attenuator, and set it as described in the "MODULATION BALANCE" above. • Connect as audio generator to the [MIC] jack, and set it as; Frequency : 1 kHz (Sine wave) Level : 40 mVrms	[MOD N L]	±2.05 to ±2.15 kHz
	-Band center-	3 • Channel : 1-10 • Transmitting		[MOD N C]	
	-Band high-	4 • Channel : 1-11 • Transmitting		[MOD N H]	
		5	• Push [ENTER] on the PC's keyboard, to store the value and quit the FM deviation (For narrow mode) adjustment mode.	[MOD N Start]	—
(Wide mode)† -Band low-	6	• Push [ENTER] on the PC's keyboard, to enter the FM deviation (For wide mode) adjustment mode.	[MOD W Start]	—	
	7	• Channel : 1-12 • Transmitting	• Connect a modulation analyzer to the antenna connector, through an attenuator, and set it as described in the "MODULATION BALANCE" above. • Connect as audio generator to the [MIC] jack, and set it as; Frequency : 1 kHz (Sine wave) Level : 40 mVrms	[MOD W L]	±4.05 to ±4.15 kHz (except [EUR-01]) ±4.15 to ±4.25 kHz ([EUR-01])
	-Band center-	8 • Channel : 1-13 • Transmitting		[MOD W C]	
	-Band high-	9 • Channel : 1-14 • Transmitting		[MOD W H]	
		10	• Push [ENTER] on the PC's keyboard, to store the value and quit the FM deviation (For wide mode) adjustment mode.	[MOD W Start]	—
(Middle mode)‡ -Band low-	11	• Push [ENTER] on the PC's keyboard, to enter the FM deviation (For middle mode) adjustment mode.	[MOD M Start]	—	
	12	• Channel : 1-15 • Transmitting	• Connect a modulation analyzer to the antenna connector, through an attenuator, and set it as described in the "MODULATION BALANCE" above. • Connect as audio generator to the [MIC] jack, and set it as; Frequency : 1 kHz (Sine wave) Level : 40 mVrms	[MOD M L]	±3.31 to ±3.41 kHz
	-Band center-	13 • Channel : 1-16 • Transmitting		[MOD M C]	
	-Band high-	14 • Channel : 1-17 • Transmitting		[MOD M H]	
		15	• Push [ENTER] on the PC's keyboard, to store the value and quit the FM deviation (For middle mode) adjustment mode.	[MOD M Start]	—

†; For all models except [USA] ‡; [EUR] only

6-3 TRANSMIT ADJUSTMENTS (continued)

1) Select an adjustment item using [↑]/[↓] on the PC's keyboard.

2) Set or modify the adjustment value as specified using [←]/[→] on the PC's keyboard, then push [ENTER].

ADJUSTMENT	TRANSCEIVER'S CONDITION	OPERATION	ADJUSTMENT ITEM	VALUE	
DIGITAL DEVIATION (Band Low)	1	• Set [TX MODE] to "16 (Digital Max Amp 600Hz Sin Wave)" on the "Adjust Utility" screen.	[TX MODE]	16 (Digital Max Amp 600Hz Sin Wave)	
	2	• Push [ENTER] on the PC's keyboard, to enter the digital deviation adjustment mode.	[MOD D Start]	–	
	3	• Channel : 1-18 • Transmitting	• Connect a modulation analyzer to the antenna connector, through an attenuator, and set it as; HPF : OFF LPF : 20 kHz De-emphasis : OFF Detector : (P–P)/2	[MOD D L]	±1.35 to ±1.39 kHz
(Band Center)	4	• Channel : 1-19 • Transmitting		[MOD D C]	
(Band High)	5	• Channel : 1-20 • Transmitting		[MOD D H]	
	6	• Push [ENTER] on the PC's keyboard, to store the value and quit the digital deviation adjustment mode.	[MOD D Start]	–	
CTCSS DEVIATION	1	• Channel : 1-21 • Transmitting	[CTCSS]	±0.65 to ±0.75 kHz Except [USA] ±0.30 to ±0.40 kHz [USA]	
DTCS DEVIATION	1	• Channel : 1-22 • Transmitting	[DTCS]		
2/5 TONE, DTMF DEVIATION	1	• Set the TX Mode to "5 (Analog DTMF "D" Tone)" on the "Adjust Utility" screen.	[TX MODE]	5 (Analog DTMF "D" Tone)	
	2	• Channel : 1-23 • Transmitting	[S.Tone]	±1.45 to ±1.55 kHz	

6-4 RECEIVE ADJUSTMENTS

1) Select an adjustment item using [↑]/[↓] on the PC's keyboard.

2) Set or modify the adjustment value as specified using [←]/[→] on the PC's keyboard, then push [ENTER].

ADJUSTMENT	TRANSCEIVER'S CONDITION	OPERATION	ADJUSTMENT ITEM	VALUE	
RX SENSITIVITY	1	NOTE: When "RX SENSITIVITY" is re-adjusted, "S-METER" must be re-adjusted too.			
		<ul style="list-style-type: none"> Channel : 1-24 Receiving 	<ul style="list-style-type: none"> Set the SSG to the antenna connector and set it as; <ul style="list-style-type: none"> Frequency : 400.000 MHz* 450.000 MHz** 350.000 MHz*** Level† : +20 dBμ (-87 dBm) Modulation : 1 kHz Deviation : ±3.0 kHz (Except [USA]) ±1.5 kHz ([USA]) 	[BPF C ALL]	Push [ENTER].
S-METER (S3 level setting)	1	NOTE: When "RX SENSITIVITY" must be adjusted before "S-METER." And when "RX SENSITIVITY" is re-adjusted, "S-METER" must be re-adjusted too.			
		<ul style="list-style-type: none"> Channel : 1-25 Receiving 	<ul style="list-style-type: none"> Connect the SSG to the antenna connector and set as; <ul style="list-style-type: none"> Frequency : 400.000 MHz* 450.000 MHz** 350.000 MHz*** Level† : +23 dBμ (-84 dBm) Modulation : None 	[RSSI S3 Level]	Push [ENTER].
(S3 level setting)	2		<ul style="list-style-type: none"> Set the SSG to the antenna connector and set it as; <ul style="list-style-type: none"> Frequency : 400.000 MHz* 450.000 MHz** 350.000 MHz*** Level† : -7 dBμ (-114 dBm) Modulation : None 	[RSSI S1 Level]	
SQUELCH	1	NOTE: When "RX SENSITIVITY" must be adjusted before "SQUELCH." And when "RX SENSITIVITY" is re-adjusted, "SQUELCH" must be re-adjusted too.			
		<ul style="list-style-type: none"> Channel : 1-26 Receiving 	<ul style="list-style-type: none"> Set the SSG to the antenna connector and set it as; <ul style="list-style-type: none"> Frequency : 470.000 MHz* 520.000 MHz** 400.000 MHz*** Level† : -14 dBμ (-121 dBm) Modulation : 1 kHz Deviation : ±3.00 kHz (Except [USA]) ±1.50 kHz ([USA]) 	-	-
	2		<ul style="list-style-type: none"> Once close the squelch by increasing [SQL] value, then decrease the value to open the squelch. 	[SQL]	Push [ENTER].

†; The output level of the standard signal generator (SSG) is indicated as the SSG's terminated circuit.

*; [Low band] versions.

**; [High band] versions.

***; [350 MHz band] versions.

PARTS LIST

[MAIN-A UNIT] (For [Low band] versions)

REF NO.	PARTS NO.	DESCRIPTION	M.	H/V LOCATION
IC2	1110002751	S.IC TA75S01F(TE85RF)	T	60/54.9
IC3	1150002380	IC RA30H4047M1-101 [EUR-01]		
	1150002380	IC RA30H4047M1-101 [EXP-01]		
	1150002400	IC RA60H4047M1-121 [USA-01]		
	1150002400	IC RA60H4047M1-121 [EXP-03]		
	1150002400	IC RA60H4047M1-121 [CHN-01]		
IC4	1110007320	S.IC NJM2591V-TE1-#ZZZB	T	57.8/24.7
IC5	1110006230	S.IC NJM2711F-TE1-#ZZZB	B	38.8/27.0
IC6	1110002751	S.IC TA75S01F(TE85RF)	B	43.0/21.2
IC7	1130011741	S.IC TC7W66FK(TE85LF)	B	28.3/24.7
IC8	1130015270	S.IC AK1541P-L	B	78.2/23.7
IC1001	1180003660	S.REG XC6408EN22PR-G	B	96.9/10.8
IC1002	1180003500	S.REG NJM7808DL1A-TE1-#FZZB	T	123.3/45.7
IC1004	1110002751	S.IC TA75S01F(TE85RF)	B	119.7/13.0
IC1005	1110007630	S.IC NJM2783V-TE1-#ZZZH	T	47.4/18.9
IC1006	1110007290	S.IC AK2330P-L	B	53.7/11.5
IC1007	1110005320	S.IC NJM13403V-TE1-#ZZZB	B	37.4/17.0
IC1008	1130009981	S.IC TC7W53FK(TE85LF)	T	40.3/19.7
IC1009	1110003091	S.IC LA4425A-E		
IC2001	1180003680	S.REG TPS62204DBVR	B	32.4/6.5
IC2002	1190002900	S.IC ADS7886SDCKR	B	14.4/9.3
IC2006	1110007770	S.IC PCM3008T2K	T	16.3/8.3
IC2007	1140013290	S.IC TMS320VC5509AZHH	T	18.0/18.4
IC2008	1130015620	S.IC EN25Q40-100GIP <MSK>	B	12.5/25.3
IC2009	1110006230	S.IC NJM2711F-TE1-#ZZZB	B	26.7/12.7
IC2010	1180003600	S.REG NJM2871BF05-TE1-#ZZZB	B	39.0/6.8
Q1	1590004090	S.TRA LDTC114YET1G <SLVJ>	B	47.2/27.1
Q2	1580000731	S.FET 3SK293(TE85LF)	B	41.5/38.7
Q3	1560000541	S.FET 2SK880-Y(T5RICOMF)	T	77.2/24.5
Q4	1530002851	S.TRA 2SC4116-BL(TE85RF)	B	67.9/25.4
Q5	1530002851	S.TRA 2SC4116-BL(TE85RF)	T	44.9/25.3
Q6	1590004090	S.TRA LDTC114YET1G <SLVJ>	T	62.2/52.2
Q7	1560000841	S.FET 2SK1829(TE85RF)	T	33.7/39.7
Q8	1530002680	S.TRA 2SC3357-T1	B	90.4/52.8
Q9	1560001360	S.FET 2SK3019 TL	T	52.2/26.3
Q10	1530003311	S.TRA 2SC5107-O(TE85RF)	B	92.8/33.1
Q11	1530003311	S.TRA 2SC5107-O(TE85RF)	B	100.5/31.7
Q12	1530004110	S.TRA MT3S37T(TE85LF)	B	97.6/30.4
Q13	1590004090	S.TRA LDTC114YET1G <SLVJ>	B	57.6/27.2
Q14	1530003311	S.TRA 2SC5107-O(TE85RF)	T	64.8/24.9
Q15	1590004500	S.TRA DMC561040R	T	101.0/34.4
Q17	1530002851	S.TRA 2SC4116-BL(TE85RF)	T	107.7/33.4
Q18	1590004090	S.TRA LDTC114YET1G <SLVJ>	T	81.5/40.8
Q19	1580000731	S.FET 3SK293(TE85LF)	B	71.4/38.4
Q20	1530002851	S.TRA 2SC4116-BL(TE85RF) [USA-01]	T	60.0/49.8
	1530002851	S.TRA 2SC4116-BL(TE85RF) [EXP-03]		
	1530002851	S.TRA 2SC4116-BL(TE85RF) [CHN-01]		
Q21	1590004090	S.TRA LDTC114YET1G <SLVJ>	T	49.5/24.8
Q23	1530002921	S.TRA 2SC4226-T1 Y25 (R25)	B	105.2/30.9
Q24	1530002921	S.TRA 2SC4226-T1 Y25 (R25)	B	98.3/24.2
Q25	1530003260	S.TRA 2SC5006-T1	B	84.9/51.5
Q1001	1590004090	S.TRA LDTC114YET1G <SLVJ>	T	110.6/44.1
Q1003	1550000190	S.FET 2SJ506STR-E	T	113.3/45.4
Q1004	1590004090	S.TRA LDTC114YET1G <SLVJ>	T	114.0/26.7
Q1005	1590004090	S.TRA LDTC114YET1G <SLVJ>	T	114.0/24.7
Q1007	1590004090	S.TRA LDTC114YET1G <SLVJ>	B	116.3/8.1
Q1008	1590000990	S.TRA DTC363EK T146	B	128.9/17.8
Q1009	1590001451	S.FET 2SJ144-GR (TE85RF)	B	113.8/11.1
Q1010	1590004090	S.TRA LDTC114YET1G <SLVJ>	B	116.1/10.9
Q1011	1540000550	S.TRA 2SD1664 T100Q	B	125.1/47.6
Q1012	1590004090	S.TRA LDTC114YET1G <SLVJ>	B	130.9/20.7
Q1013	1510000920	S.TRA 2SA1577 T106 Q	T	107.7/44.3
Q1014	1520000460	S.TRA 2SB1132 T100 R	B	123.5/21.1
Q1015	1590004590	S.TRA DMC506010R	B	118.9/20.4
Q1016	1590004090	S.TRA LDTC114YET1G <SLVJ>	T	107.8/39.2
Q1017	1520000460	S.TRA 2SB1132 T100 R	T	120.1/35.2
Q1018	1590004090	S.TRA LDTC114YET1G <SLVJ>	B	126.4/43.3
Q1019	1590004590	S.TRA DMC506010R	B	123.8/35.8
Q1020	1590004090	S.TRA LDTC114YET1G <SLVJ>	T	42.6/22.5
Q1021	1590004090	S.TRA LDTC114YET1G <SLVJ>	B	126.4/41.3
Q2001	1590004040	S.TRA LDTA123YET1G <SLVJ>	B	26.9/26.6
D2	1750001910	S.DIO HVD144AKRF-E	B	52.6/28.5
D3	1750001910	S.DIO HVD144AKRF-E	B	52.6/27.3
D4	1750000711	S.DIO HVC350BTRF-E	B	36.0/40.2
D5	1750002060	S.DIO RNY752E-21	T	26.5/53.3
D7	1750001910	S.DIO HVD144AKRF-E	B	25.3/45.3
D8	1750001910	S.DIO HVD144AKRF-E	B	43.4/27.3
D9	1750001910	S.DIO HVD144AKRF-E	B	43.4/28.6
D10	1750000711	S.DIO HVC350BTRF-E	B	55.5/39.9
D11	1750001820	S.DIO LRB706F-40T1G <SLVJ>	B	8.2/49.9
D12	1750001820	S.DIO LRB706F-40T1G <SLVJ>	B	28.8/49.9
D13	1750001910	S.DIO HVD144AKRF-E	T	66.3/28.1
D14	1750001910	S.DIO HVD144AKRF-E	T	69.5/28.1
D15	1790001261	S.DIO MA2S077G0L	B	82.2/39.2
D16	1750000711	S.DIO HVC350BTRF-E	B	106.7/20.3
D17	1750001910	S.DIO HVD144AKRF-E	T	70.6/41.6
D18	1750001910	S.DIO HVD144AKRF-E	T	74.5/41.6
D19	1750000711	S.DIO HVC350BTRF-E	B	61.9/39.9
D20	1750000711	S.DIO HVC350BTRF-E	B	28.0/40.2
D21	1750000711	S.DIO HVC350BTRF-E	B	36.0/41.6
D22	1750000711	S.DIO HVC350BTRF-E	B	28.0/41.6
D23	1750000711	S.DIO HVC350BTRF-E	B	52.8/42.6
D24	1750002060	S.DIO RNY752E-21	T	35.1/56.7
D25	1750000581	S.DIO 1SV307(TPH3F)	B	83.5/42.1

[MAIN-A UNIT] (For [Low band] versions)

REF NO.	PARTS NO.	DESCRIPTION	M.	H/V LOCATION
D26	1750001650	S.VAR 1SV309(TPH3F)	B	101.8/25.9
D29	1750001820	S.DIO LRB706F-40T1G <SLVJ>	B	19.2/49.9
D33	1750000711	S.VAR HVC350BTRF-E	B	97.8/20.5
D62	1750000711	S.VAR HVC350BTRF-E	B	91.7/22.8
D64	1750002270	S.VAR HVD396CKRF-E	B	106.7/21.5
D66	1750000370	S.DIO DA221 TL	T	33.7/37.1
D67	1750002170	S.DIO DB2S31400L [EUR-01]	T	31.8/39.7
	1750002170	S.DIO DB2S31400L [EXP-01]		
	1790001241	S.DIO MA2S7280GL [USA-01]		
	1750002270	S.DIO MA2S7280GL [EXP-03]		
	1750002170	S.DIO DB2S31400L [CHN-01]		
D1002	1790000700	DIO DSA3A1		
D1003	1750000370	S.DIO DA221 TL	B	114.0/8.2
D1004	1750000370	S.DIO DA221 TL	B	114.1/6.1
D1005	1750000370	S.DIO DA221 TL	T	113.2/7.4
D1006	1750000370	S.DIO DA221 TL	T	113.0/10.3
D1007	1750001810	S.DIO L1SS400T1G <SLVJ>	B	129.0/20.7
D1008	1750000370	S.DIO DA221 TL	B	124.0/43.3
D2002	1750002170	S.DIO DB2S31400L [EUR-01]	T	24.9/18.0
	1750002170	S.DIO DB2S31400L [EXP-01]		
	1790001241	S.DIO MA2S7280GL [USA-01]		
	1790001241	S.DIO MA2S7280GL [EXP-03]		
	1750002170	S.DIO DB2S31400L [CHN-01]		
D2003	1750002170	S.DIO DB2S31400L [EUR-01]	B	10.7/30.5
	1750002170	S.DIO DB2S31400L [EXP-01]		
	1790001241	S.DIO MA2S7280GL [USA-01]		
	1750002170	S.DIO DB2S31400L [EXP-01]		
	1790001241	S.DIO MA2S7280GL [EXP-03]		
	1750002170	S.DIO DB2S31400L [CHN-01]		
D2004	1750002170	S.DIO DB2S31400L [EUR-01]	B	22.1/21.4
	1750002170	S.DIO DB2S31400L [EXP-01]		
	1790001241	S.DIO MA2S7280GL [USA-01]		
	1790001241	S.DIO MA2S7280GL [EXP-03]		
	1750002170	S.DIO DB2S31400L [CHN-01]		
D2005	1750002170	S.DIO DB2S31400L [EUR-01]	B	17.5/26.3
	1750002170	S.DIO DB2S31400L [EXP-01]		
	1790001241	S.DIO MA2S7280GL [USA-01]		
	1790001241	S.DIO MA2S7280GL [EXP-03]		
	1750002170	S.DIO DB2S31400L [CHN-01]		
D2006	1750002170	S.DIO DB2S31400L [EUR-01]	T	12.0/25.3
	1750002170	S.DIO DB2S31400L [EXP-01]		
	1790001241	S.DIO MA2S7280GL [USA-01]		
	1790001241	S.DIO MA2S7280GL [EXP-03]		
	1750002170	S.DIO DB2S31400L [CHN-01]		
D2008	1750002020	S.DIO DA2S10100L	T	100.3/6.5
F11	2020002570	CER LTM450HW <JJE>		
F12	2020002410	CER LTM450FW <JJE>		
F13	2020002610	S.CER LTUCG450G <JJE>	T	36.3/28.0
F14	2030000870	S.MON MFT46.3P3 46.350 MHz (FL-442)	T	66.9/34.9
F15	2010002760	S.XTA MFT46.3J 46.350 MHz (FL-448)	T	75.8/34.9
F16	2040001440	S.LC NFE31PT152Z1E9L (NFM60R20T152)	B	97.7/62.2
F17	2040001440	S.LC NFE31PT152Z1E9L (NFM60R20T152)	B	97.7/58.9
F18	2040001440	S.LC NFE31PT152Z1E9L (NFM60R20T152) [USA-01]	B	97.7/55.4
	2040001440	S.LC NFE31PT152Z1E9L (NFM60R20T152) [EXP-03]		
	2040001440	S.LC NFE31PT152Z1E9L (NFM60R20T152) [CHN-01]		
X1	6070000300	S.DIS JTBM450CX24 <JJE>	B	51.4/22.5
X2	6050013000	S.XTA CR-892 TTS14VSB-A8 15.3 MHz	B	71.5/21.0
X2001	6050013170	S.XTA CR-914 TTS18VSE-A11 12.288 MHz	B	27.0/18.2
L1	6200010150	S.COI AS080340-15N	B	8.4/62.7
L2	6200010150	S.COI AS080340-15N	B	12.9/55.5
L3	6200010150	S.COI AS080340-15N	B	20.7/55.5
L4	6200013100	S.COI 0.45-1.5-STL 18.3N <COMO>	T	31.1/50.5
L5	6200010420	S.COI FHW1210HC 1R0JGT <JJE>	T	38.5/58.4
L6	6200010150	S.COI AS080340-15N	B	27.3/55.5
L7	6200012870	S.COI 0.30-1.4-5TR 23.5N <COMO>	B	28.8/37.8
L8	6200012870	S.COI 0.30-1.4-5TR 23.5N <COMO>	B	35.2/37.8
L9	6200012170	S.COI MLG1608S R18J-T	B	65.8/24.7
L10	6200011690	S.COI C2520C-12NG-A	B	49.0/39.8
L11	6200011690	S.COI C2520C-12NG-A	B	57.8/40.5
L12	6200012170	S.COI MLG1608S R18J-T	B	62.3/22.4
L13	6200007901	S.COI ELJRF 22NJFB	T	85.1/29.9
L16	6200010150	S.COI AS080340-15N	B	38.2/65.2
L17	6200005661	S.COI ELJRE 10NGFA	B	85.4/57.9
L18	6200005701	S.COI ELJRE 22NGFA	B	88.1/58.9
L19	6200005711	S.COI ELJRE 27NGFA	B	89.9/56.0
L20	6200010090	S.COI ELJND R82JF	B	68.9/40.9
L21				

[MAIN-A UNIT] (For [Low band] versions)

REF NO.	PARTS NO.	DESCRIPTION	M.	H/V LOCATION
L54	6200007370	S.COI ELJFC R82K-F	T	100.0/30.4
L55	6200004741	S.COI NLY25F-1R2J	B	103.7/33.8
L56	6200011690	S.COI C2520C-12NG-A	B	64.2/40.5
L57	6200011860	S.COI LQW18ANR47G00D	B	92.6/24.0
L58	6200011860	S.COI LQW18ANR47G00D	B	105.9/19.1
L1001	6200004660	S.COI MLF1608A 1R8K-T	T	79.8/13.3
L2001	6200014160	S.COI VLFC4028T-100M1R0-2	T	35.9/7.6
L2002	6200007830	S.COI ELJFC 4R7K-F	B	31.2/11.2
R1	7030000620	S.RES MCR10EZJH 100 K (104)	B	12.3/65.5
R4	7030003560	S.RES ERJ3GEYJ 103 V (10K)	B	16.4/50.6
R5	7030008010	S.RES ERJ2GEJ 123 X (12K) [EUR-01]	B	11.2/49.6
	7030008010	S.RES ERJ2GEJ 123 X (12K) [EXP-01]		
	7030005220	S.RES ERJ2GEJ 223 X (22K) [USA-01]		
	7030005220	S.RES ERJ2GEJ 223 X (22K) [EXP-03]		
	7030005220	S.RES ERJ2GEJ 223 X (22K) [CHN-01]		
R6	7030008010	S.RES ERJ2GEJ 123 X (12K) [EUR-01]	B	19.8/48.1
	7030008010	S.RES ERJ2GEJ 123 X (12K) [EXP-01]		
	7030005220	S.RES ERJ2GEJ 223 X (22K) [USA-01]		
	7030005220	S.RES ERJ2GEJ 223 X (22K) [EXP-03]		
	7030005220	S.RES ERJ2GEJ 223 X (22K) [CHN-01]		
R7	7030003560	S.RES ERJ3GEYJ 103 V (10K)	B	8.2/53.2
R8	7030006070	S.RES ERJ12YJ101U (100)	B	45.7/51.9
R9	7030003560	S.RES ERJ3GEYJ 103 V (10K)	B	25.6/50.6
R10	7030008010	S.RES ERJ2GEJ 123 X (12K) [EUR-01]	B	22.2/48.1
	7030008010	S.RES ERJ2GEJ 123 X (12K) [EXP-01]		
	7030005220	S.RES ERJ2GEJ 223 X (22K) [USA-01]		
	7030005220	S.RES ERJ2GEJ 223 X (22K) [EXP-03]		
	7030005220	S.RES ERJ2GEJ 223 X (22K) [CHN-01]		
R11	7030005050	S.RES ERJ2GEJ 103 X (10K)	B	31.5/40.5
R12	7030004980	S.RES ERJ2GEJ 101 X (100)	B	39.2/39.5
R13	7030005050	S.RES ERJ2GEJ 103 X (10K)	B	32.5/40.5
R14	7030005050	S.RES ERJ2GEJ 103 X (10K)	B	32.5/38.8
R15	7030005700	S.RES ERJ2GEJ 274 X (270K)	B	39.2/38.6
R16	7030004990	S.RES ERJ2GEJ 221 X (220) [EUR-01]	B	39.5/40.7
	7030004980	S.RES ERJ2GEJ 101 X (100) [EXP-01]		
	7030004980	S.RES ERJ2GEJ 101 X (100) [USA-01]		
	7030004980	S.RES ERJ2GEJ 101 X (100) [EXP-03]		
	7030004980	S.RES ERJ2GEJ 101 X (100) [CHN-01]		
R17	7030005530	S.RES ERJ2GEJ 100 X (10)	B	51.5/40.2
R18	7030005050	S.RES ERJ2GEJ 103 X (10K)	B	60.8/40.5
R19	7030005090	S.RES ERJ2GEJ 104 X (100K)	B	39.2/36.8
R20	7030005120	S.RES ERJ2GEJ 102 X (1K)	B	52.8/38.6
R21	7030005050	S.RES ERJ2GEJ 103 X (10K)	B	54.1/40.2
R22	7030005050	S.RES ERJ2GEJ 103 X (10K)	B	56.2/37.4
R23	7030005050	S.RES ERJ2GEJ 103 X (10K)	B	54.1/41.2
R29	7030009200	S.RES ERJ2GEJ 390 X (39)	B	74.0/40.6
	7030005570	S.RES ERJ2GEJ 820 X (82) [EXP-01]		
	7030005570	S.RES ERJ2GEJ 820 X (82) [USA-01]		
	7030005570	S.RES ERJ2GEJ 820 X (82) [EXP-03]		
	7030005570	S.RES ERJ2GEJ 820 X (82) [CHN-01]		
R30	7030007300	S.RES ERJ2GEJ 332 X (3.3K)	B	71.3/41.2
R31	7030004980	S.RES ERJ2GEJ 101 X (100)	B	66.9/37.4
R33	7030005600	S.RES ERJ2GEJ 273 X (27K)	T	71.9/42.7
R34	7030005110	S.RES ERJ2GEJ 224 X (220K)	T	64.9/23.1
R35	7030005530	S.RES ERJ2GEJ 100 X (10)	T	64.9/22.2
R36	7030005030	S.RES ERJ2GEJ 152 X (1.5K)	B	56.2/21.7
R37	7030008400	S.RES ERJ2GEJ 182 X (1.8K)	B	56.6/25.5
R38	7030005090	S.RES ERJ2GEJ 104 X (100K)	T	61.7/17.8
R39	7030004970	S.RES ERJ2GEJ 470 X (47)	B	58.4/22.2
R40	7030005030	S.RES ERJ2GEJ 152 X (1.5K)	B	58.4/23.2
R41	7030010040	S.RES ERJ2GEJ-JPW	T	60.8/17.8
R42	7030005070	S.RES ERJ2GEJ 683 X (68K)	T	51.0/24.3
R43	7030005000	S.RES ERJ2GEJ 471 X (470)	T	55.6/19.1
R44	7030005310	S.RES ERJ2GEJ 124 X (120K)	T	54.0/24.7
R45	7030005310	S.RES ERJ2GEJ 124 X (120K)	T	52.2/24.7
R46	7030008410	S.RES ERJ2GEJ 392 X (3.9K)	T	54.0/22.9
R48	7030008300	S.RES ERJ2GEJ 184 X (180K) [USA-01]	T	56.8/53.2
	7030008300	S.RES ERJ2GEJ 184 X (180K) [EXP-03]		
	7030008300	S.RES ERJ2GEJ 184 X (180K) [CHN-01]		
R49	7520000241	S.POS PRF18BC471QB5RB [USA-01]	T	47.3/53.2
	7520000241	S.POS PRF18BC471QB5RB [EXP-03]		
	7520000241	S.POS PRF18BC471QB5RB [CHN-01]		
R50	7030005050	S.RES ERJ2GEJ 103 X (10K)	B	80.1/37.9
R51	7030008290	S.RES ERJ2GEJ 183 X (18K) [EUR-01]	T	61.8/49.8
	7030008290	S.RES ERJ2GEJ 183 X (18K) [EXP-01]		
	7030005080	S.RES ERJ2GEJ 823 X (82K) [USA-01]		
	7030005080	S.RES ERJ2GEJ 823 X (82K) [EXP-03]		
	7030005080	S.RES ERJ2GEJ 823 X (82K) [CHN-01]		
R52	7030005070	S.RES ERJ2GEJ 683 X (68K)	T	58.7/52.1
R53	7030004990	S.RES ERJ2GEJ 221 X (220)	T	57.8/53.2
R54	7030005050	S.RES ERJ2GEJ 103 X (10K) [EUR-01]	B	58.8/55.7
	7030005050	S.RES ERJ2GEJ 103 X (10K) [EXP-01]		
	7030005220	S.RES ERJ2GEJ 223 X (22K) [USA-01]		
	7030005220	S.RES ERJ2GEJ 223 X (22K) [EXP-03]		
	7030005220	S.RES ERJ2GEJ 223 X (22K) [CHN-01]		
R56	7030005110	S.RES ERJ2GEJ 224 X (220K) [EUR-01]	T	63.3/55.0
	7030005110	S.RES ERJ2GEJ 224 X (220K) [EXP-01]		
	7030005100	S.RES ERJ2GEJ 154 X (150K) [USA-01]		
	7030005100	S.RES ERJ2GEJ 154 X (150K) [EXP-03]		
	7030005100	S.RES ERJ2GEJ 154 X (150K) [CHN-01]		
R57	7030005050	S.RES ERJ2GEJ 103 X (10K)	B	58.8/54.8
R58	7030004980	S.RES ERJ2GEJ 101 X (100)	T	64.2/55.0
R59	7030008290	S.RES ERJ2GEJ 183 X (18K) [EUR-01]	T	59.7/52.1
	7030008290	S.RES ERJ2GEJ 183 X (18K) [EXP-01]		
	7030007350	S.RES ERJ2GEJ 393 X (39K) [USA-01]		
	7030007350	S.RES ERJ2GEJ 393 X (39K) [EXP-03]		
	7030007350	S.RES ERJ2GEJ 393 X (39K) [CHN-01]		
R61	7030004970	S.RES ERJ2GEJ 470 X (47)	B	90.5/49.5
R62	7030008290	S.RES ERJ2GEJ 183 X (18K)	B	89.6/49.5
R66	7030005090	S.RES ERJ2GEJ 104 X (100K)	B	84.9/49.1
R67	7030004980	S.RES ERJ2GEJ 101 X (100)	B	83.0/47.3
R68	7030005050	S.RES ERJ2GEJ 103 X (10K)	B	82.6/48.7
R69	7030005040	S.RES ERJ2GEJ 472 X (4.7K)	B	84.0/38.0

[MAIN-A UNIT] (For [Low band] versions)

REF NO.	PARTS NO.	DESCRIPTION	M.	H/V LOCATION
R70	7030004990	S.RES ERJ2GEJ 221 X (220)	B	92.8/35.8
R71	7030007260	S.RES ERJ2GEJ 330 X (33)	B	95.3/33.8
R72	7030004980	S.RES ERJ2GEJ 101 X (100)	B	86.5/49.1
R73	7030005000	S.RES ERJ2GEJ 471 X (470) [EUR-01]	B	99.5/35.3
	7030004980	S.RES ERJ2GEJ 101 X (100) [EXP-01]		
	7030004980	S.RES ERJ2GEJ 101 X (100) [USA-01]		
	7030004980	S.RES ERJ2GEJ 101 X (100) [EXP-03]		
	7030004980	S.RES ERJ2GEJ 101 X (100) [CHN-01]		
R74	7030005080	S.RES ERJ2GEJ 823 X (82K)	B	101.3/33.7
R75	7030005720	S.RES ERJ2GEJ 563 X (56K)	B	97.6/32.2
R76	7030009270	S.RES ERJ2GEJ 821 X (820)	B	96.7/32.2
R77	7030005120	S.RES ERJ2GEJ 102 X (1K)	T	105.6/36.0
R78	7030008370	S.RES ERJ2GEJ 561 X (56K)	T	102.5/32.5
R79	7030006020	S.RES RR0510P-682-D (6.8K)	B	96.5/23.7
R80	7030009270	S.RES ERJ2GEJ 821 X (820)	T	100.0/32.5
R83	7030006020	S.RES RR0510P-682-D (6.8K)	B	106.4/29.1
R84	7030006020	S.RES RR0510P-682-D (6.8K)	B	106.4/29.2
R85	7030006020	S.RES RR0510P-682-D (6.8K)	B	95.6/25.3
R86	7030005110	S.RES ERJ2GEJ 224 X (220K)	B	102.6/24.4
R87	7030005530	S.RES ERJ2GEJ 100 X (10)	B	102.6/27.5
R89	7030005050	S.RES ERJ2GEJ 103 X (10K)	T	79.0/25.0
R90	7030005170	S.RES ERJ2GEJ 474 X (470K)	T	95.9/15.3
R92	7030005100	S.RES ERJ2GEJ 154 X (150K)	T	94.3/14.4
R93	7030005600	S.RES ERJ2GEJ 273 X (27K)	B	81.3/25.8
R95	7030005710	S.RES ERJ2GEJ 121 X (120)	B	83.8/24.5
R96	7030007290	S.RES ERJ2GEJ 222 X (2.2K)	B	83.8/23.5
R97	7030010040	S.RES ERJ2GEJ-JPW	B	82.2/24.5
R98	7030007290	S.RES ERJ2GEJ 222 X (2.2K)	T	109.5/33.8
R100	7030005240	S.RES ERJ2GEJ 473 X (47K)	T	76.1/20.3
R101	7030004980	S.RES ERJ2GEJ 101 X (100)	T	77.9/22.2
R123	7030005530	S.RES ERJ2GEJ 100 X (10)	T	68.2/40.4
R125	7030008370	S.RES ERJ2GEJ 561 X (560)	T	65.6/29.2
R171	7030004980	S.RES ERJ2GEJ 101 X (100)	T	45.5/28.6
R172	7030008300	S.RES ERJ2GEJ 184 X (180K)	T	44.2/27.1
R173	7030005120	S.RES ERJ2GEJ 102 X (1K)	T	42.9/26.4
R174	7030005290	S.RES ERJ2GEJ 682 X (6.8K)	T	42.0/28.8
R175	7030009290	S.RES ERJ2GEJ 562 X (5.6K)	T	41.6/27.6
R176	7030005030	S.RES ERJ2GEJ 152 X (1.5K)	T	42.0/26.4
R178	7030004970	S.RES ERJ2GEJ 470 X (47)	B	39.8/24.4
R211	7030004970	S.RES ERJ2GEJ 470 X (47)	T	82.7/23.8
R212	7030010040	S.RES ERJ2GEJ-JPW	T	82.6/60.4
R234	7030005720	S.RES ERJ2GEJ 563 X (56K) [EUR-01]	B	92.8/34.9
	7030005070	S.RES ERJ2GEJ 683 X (68K) [EXP-01]		
	7030005070	S.RES ERJ2GEJ 683 X (68K) [USA-01]		
	7030005070	S.RES ERJ2GEJ 683 X (68K) [EXP-03]		
	7030005070	S.RES ERJ2GEJ 683 X (68K) [CHN-01]		
R235	7030004980	S.RES ERJ2GEJ 101 X (100)	B	81.0/37.9
R236	7030007570	S.RES ERJ2GEJ 122 X (1.2K)	B	67.4/22.7
R237	7030007060	S.RES ERJ2GEJ 684X (680K)	B	67.4/23.6
R289	7030005240	S.RES ERJ2GEJ 473 X (47K)	T	95.9/12.6
R290	7030005010	S.RES ERJ2GEJ 681 X (680)	T	63.2/23.1
R291	7030005090	S.RES ERJ2GEJ 104 X (100K)	T	94.3/13.5
R293	7030006610	S.RES ERJ2GEJ 394 X (390K)	T	88.4/12.0
R295	7030006610	S.RES ERJ2GEJ 394 X (390K)	T	101.0/17.3
R299	7030008300	S.RES ERJ2GEJ 184 X (180K)	B	74.6/38.5
R300	7030005720	S.RES ERJ2GEJ 563 X (56K)	B	76.8/40.6
R301	7030005100	S.RES ERJ2GEJ 154 X (150K)	B	67.5/40.5
R302	7030005720	S.RES ERJ2GEJ 563 X (56K)	B	66.9/38.3
R308	7030009140	S.RES ERJ2GEJ 272 X (2.7K)	T	56.9/54.9
R311	7030010040	S.RES ERJ2GEJ-JPW	B	94.9/32.2
R317	7030005120	S.RES ERJ2GEJ 102 X (1K)	T	105.6/37.4
R319	7030007340	S.RES ERJ2GEJ 153 X (15K)	T	37.3/37.9
R320	7030005170	S.RES ERJ2GEJ 474 X (470K)	T	35.5/36.2
R328	7030010040	S.RES ERJ2GEJ-JPW	B	104.8/29.1
R334	7030005000	S.RES ERJ2GEJ 471 X (470)	T	87.6/61.3
R337	7030005530	S.RES ERJ2GEJ 100 X (10)	T	87.1/62.7
R338	7030005000	S.RES ERJ2GEJ 471 X (470)	T	87.6/64.1
R339	7030010040	S.RES ERJ2GEJ-JPW	B	96.5/25.3
R340	7030005050	S.RES ERJ2GEJ 103 X (10K)	B	72.4/25.3
R350	7030005600	S.RES ERJ2GEJ 273 X (27K)	B	52.9/26.2
R351	7030005600	S.RES ERJ2GEJ 273 X (27K)	B	43.2/26.3
R352	7030007300	S.RES ERJ2GEJ 332 X (3.3K)	B	50.9/26.8
R353	7030005210	S.RES ERJ2GEJ 822 X (8.2K)	B	45.4/27.3
R354	7030005210	S.RES ERJ2GEJ 822 X (8.2K)	B	46.1/29.0
R394	7030010040	S.RES ERJ2GEJ-JPW	B	100.1/27.3
R395	7030010040	S.RES ERJ2GEJ-JPW	B	26.7/46.8
R478	7030007340	S.RES ERJ2GEJ 153 X (15K)	B	35.5/26.3
R479	7030005600	S.RES ERJ2GEJ 273 X (27K)	T	66.8/27.4
R483	7030007300	S.RES ERJ2GEJ 332 X (3.3K)	T	71.5/28.8
R484	7030007300	S.RES ERJ2GEJ 332 X (3.3K)	T	76.5/42.5
R485	7030010040	S.RES ERJ2GEJ-JPW	T	77.0/40.4
R486	7030005000	S.RES ERJ2GEJ 471 X (470)	T	73.2/29.7
R488	7030007300	S.RES ERJ2GEJ 332 X (3.3K)	T	68.6/42.7
R489	7030007300	S.RES ERJ2GEJ 332 X (3.3K)	T	6

[MAIN-A UNIT] (For [Low band] versions)

REF NO.	PARTS NO.	DESCRIPTION	M.	H/V LOCATION
R1005	7030005120	S.RES ERJ2GEJ 102 X (1K)	T	112.3/16.5
R1006	7030005090	S.RES ERJ2GEJ 104 X (100K)	B	112.4/8.1
R1008	7030010040	S.RES ERJ2GEJ-JPW	T	124.9/24.8
R1009	7030005050	S.RES ERJ2GEJ 103 X (10K)	T	133.3/49.2
R1010	7030005050	S.RES ERJ2GEJ 103 X (10K)	T	128.6/23.8
R1012	7030005040	S.RES ERJ2GEJ 472 X (4.7K)	T	110.6/46.0
R1013	7030005240	S.RES ERJ2GEJ 473 X (47K)	T	114.7/24.9
R1014	7030005090	S.RES ERJ2GEJ 104 X (100K)	T	98.3/12.1
R1015	7030005120	S.RES ERJ2GEJ 102 X (1K)	B	115.3/22.8
R1016	7030005090	S.RES ERJ2GEJ 104 X (100K)	B	115.6/6.1
R1018	7030005090	S.RES ERJ2GEJ 104 X (100K)	T	111.7/7.0
R1020	7030005090	S.RES ERJ2GEJ 104 X (100K)	B	114.7/24.9
R1021	7030005120	S.RES ERJ2GEJ 102 X (1K)	B	116.5/6.1
R1022	7030005120	S.RES ERJ2GEJ 102 X (1K)	T	114.9/7.1
R1023	7030005050	S.RES ERJ2GEJ 103 X (10K)	B	125.2/15.7
R1024	7030007290	S.RES ERJ2GEJ 222 X (2.2K)	B	131.6/17.6
R1025	7030000480	S.RES MCR10EZHH 6.8K (682)	B	129.4/47.0
R1026	7030000480	S.RES MCR10EZHH 6.8K (682)	B	129.4/48.8
R1027	7030010040	S.RES ERJ2GEJ-JPW	T	113.7/16.5
R1028	7030004970	S.RES ERJ2GEJ 470 X (47K)	B	114.9/13.4
R1029	7030005120	S.RES ERJ2GEJ 102 X (1K)	B	115.3/10.5
R1030	7030005050	S.RES ERJ2GEJ 103 X (10K)	T	114.4/10.5
R1031	7030005050	S.RES ERJ2GEJ 103 X (10K)	B	117.8/7.7
R1032	7030005050	S.RES ERJ2GEJ 103 X (10K)	B	127.1/19.9
R1033	7030000480	S.RES MCR10EZHH 6.8K (682)	B	129.4/45.2
R1034	7030005040	S.RES ERJ2GEJ 472 X (4.7K)	B	123.6/17.5
R1035	7030005050	S.RES ERJ2GEJ 103 X (10K)	T	107.8/42.5
R1036	7030005040	S.RES ERJ2GEJ 472 X (4.7K)	T	107.8/41.2
R1037	7030005090	S.RES ERJ2GEJ 104 X (100K)	T	95.9/13.5
R1038	7030005120	S.RES ERJ2GEJ 102 X (1K)	B	125.6/36.3
R1039	7030005090	S.RES ERJ2GEJ 104 X (100K)	B	113.7/12.9
R1040	7030005160	S.RES ERJ2GEJ 105 X (1M)	T	111.2/12.9
R1043	7030005160	S.RES ERJ2GEJ 105 X (1M)	B	112.0/11.0
R1044	7030005090	S.RES ERJ2GEJ 104 X (100K)	B	117.9/9.9
R1045	7030005050	S.RES ERJ2GEJ 103 X (10K)	B	120.4/17.1
R1046	7030005800	S.RES RR0510P-102-D (1K)	B	119.7/9.0
R1047	7030005050	S.RES ERJ2GEJ 103 X (10K)	B	119.4/18.6
R1048	7030009710	S.RES ERJ2GEJ 203 X (20K)	B	119.0/22.4
R1049	7030005040	S.RES ERJ2GEJ 472 X (4.7K)	B	116.7/19.7
R1050	7030007290	S.RES ERJ2GEJ 222 X (2.2K)	B	123.0/38.1
R1054	7030008270	S.RES RR0510P-104-D (100K)	B	119.7/9.9
R1055	7030005090	S.RES ERJ2GEJ 104 X (100K)	B	120.4/15.2
R1056	7030008270	S.RES RR0510P-104-D (100K)	B	118.8/10.8
R1057	7030005100	S.RES ERJ2GEJ 154 X (150K)	B	118.8/15.2
R1059	7410001130	S.ARR EXB28V102JX	T	69.7/14.8
R1060	7410001130	S.ARR EXB28V102JX	T	63.4/14.8
R1062	7030008270	S.RES RR0510P-104-D (100K)	B	116.0/14.8
R1063	7030007340	S.RES ERJ2GEJ 153 X (15K)	B	42.8/22.4
R1064	7030005090	S.RES ERJ2GEJ 104 X (100K)	T	40.5/23.1
R1068	7030005120	S.RES ERJ2GEJ 102 X (1K)	T	74.3/14.1
R1069	7030005120	S.RES ERJ2GEJ 102 X (1K)	T	72.6/14.1
R1070	7030005120	S.RES ERJ2GEJ 102 X (1K)	T	57.3/15.1
R1071	7030005090	S.RES ERJ2GEJ 104 X (100K)	T	51.7/16.7
R1072	7030005040	S.RES ERJ2GEJ 472 X (4.7K)	T	52.9/16.3
R1073	7030005700	S.RES ERJ2GEJ 274 X (270K)	B	50.8/18.7
R1074	7030005100	S.RES ERJ2GEJ 154 X (150K)	T	32.7/20.6
R1075	7030008010	S.RES ERJ2GEJ 123 X (12K)	T	36.3/21.5
R1076	7030005090	S.RES ERJ2GEJ 104 X (100K)	B	35.0/20.5
R1077	7030005170	S.RES ERJ2GEJ 474 X (470K)	B	36.6/20.2
R1078	7030005090	S.RES ERJ2GEJ 104 X (100K)	B	32.2/15.4
R1080	7030005310	S.RES ERJ2GEJ 124 X (120K)	B	40.1/13.5
R1081	7030008290	S.RES ERJ2GEJ 183 X (18K)	T	42.5/19.5
R1082	7410001130	S.ARR EXB28V102JX	T	56.9/6.7
R1083	7030005120	S.RES ERJ2GEJ 102 X (1K)	B	69.1/8.8
R1084	7410001130	S.ARR EXB28V102JX	T	61.7/6.1
R1085	7030005120	S.RES ERJ2GEJ 102 X (1K)	B	49.5/9.9
R1086	7030005100	S.RES ERJ2GEJ 154 X (150K)	B	32.2/18.5
R1087	7030007340	S.RES ERJ2GEJ 153 X (15K)	B	31.3/15.2
R1088	7030005160	S.RES ERJ2GEJ 105 X (1M)	B	31.3/16.9
R1089	7030005050	S.RES ERJ2GEJ 103 X (10K)	B	44.2/16.9
R1090	7030008300	S.RES ERJ2GEJ 184 X (180K)	B	36.5/13.4
R1092	7030008400	S.RES ERJ2GEJ 182 X (1.8K)	B	38.3/13.5
R1093	7030005090	S.RES ERJ2GEJ 104 X (100K)	B	42.9/15.5
R1094	7030005090	S.RES ERJ2GEJ 104 X (100K)	T	55.7/12.8
R1095	7030009290	S.RES ERJ2GEJ 562 X (5.6K)	T	55.7/13.7
R1096	7030005100	S.RES ERJ2GEJ 154 X (150K)	B	35.6/13.4
R1097	7030007290	S.RES ERJ2GEJ 222 X (2.2K)	T	55.2/11.6
R1098	7510001730	S.THE ERTJJOEP 473J	T	74.9/15.5
R1099	7030008270	S.RES RR0510P-104-D (100K)	T	72.5/15.5
R1100	7410001130	S.ARR EXB28V102JX	T	75.3/6.0
R1101	7030005290	S.RES ERJ2GEJ 682 X (6.8K)	B	44.0/20.4
R1102	7030005040	S.RES ERJ2GEJ 472 X (4.7K)	B	42.4/16.4
R1103	7030005290	S.RES ERJ2GEJ 682 X (6.8K)	B	52.9/18.3
R1105	7030003860	S.RES ERJ3GE JPW V	T	127.8/48.9
R1106	7030009290	S.RES ERJ2GEJ 562 X (5.6K)	B	41.0/20.8
R1107	7030008410	S.RES ERJ2GEJ 392 X (3.9K)	B	39.2/20.8
R1108	7030005240	S.RES ERJ2GEJ 473 X (47K)	B	124.9/41.7
R1111	7030005060	S.RES ERJ2GEJ 333 X (33K)	T	36.3/19.7
R1112	7030005230	S.RES ERJ2GEJ 334 X (330K)	B	41.5/19.6
R1113	7030005720	S.RES ERJ2GEJ 563 X (56K) [EUR-01]	B	44.0/21.3
	7030005720	S.RES ERJ2GEJ 563 X (56K) [EXP-01]		
	7030005720	S.RES ERJ2GEJ 563 X (56K) [CHN-01]		
R1114	7030005120	S.RES ERJ2GEJ 102 X (1K)	T	65.8/6.4
R1115	7030005120	S.RES ERJ2GEJ 102 X (1K)	T	65.8/5.4
R1116	7030007300	S.RES ERJ2GEJ 332 X (3.3K)	T	73.7/15.0
R1117	7030005090	S.RES ERJ2GEJ 104 X (100K)	B	42.4/18.2
R1119	7030003860	S.RES ERJ3GE JPW V [CHN-01] only	T	99.5/68.6
R2003	7030007250	S.RES ERJ2GEJ 220 X (22K)	B	16.7/6.8
R2004	7030005210	S.RES ERJ2GEJ 822 X (8.2K)	B	12.6/8.8
R2005	7030005210	S.RES ERJ2GEJ 822 X (8.2K)	B	15.8/6.8
R2009	7030007290	S.RES ERJ2GEJ 222 X (2.2K)	B	10.5/11.7
R2010	7030004980	S.RES ERJ2GEJ 101 X (100)	T	11.5/11.7
R2011	7030004980	S.RES ERJ2GEJ 101 X (100)	T	20.3/10.4
R2012	7030004980	S.RES ERJ2GEJ 101 X (100)	T	22.5/11.3
R2013	7030005240	S.RES ERJ2GEJ 473 X (47K)	B	19.8/12.0

[MAIN-A UNIT] (For [Low band] versions)

REF NO.	PARTS NO.	DESCRIPTION	M.	H/V LOCATION
R2015	7030005240	S.RES ERJ2GEJ 473 X (47K)	T	18.4/11.6
R2016	7030010040	S.RES ERJ2GEJ-JPW	B	24.0/5.8
R2019	7030010040	S.RES ERJ2GEJ-JPW	B	9.9/17.9
R2020	7030010040	S.RES ERJ2GEJ-JPW	B	14.4/11.1
R2021	7030004980	S.RES ERJ2GEJ 101 X (100)	B	23.6/12.1
R2022	7030004980	S.RES ERJ2GEJ 101 X (100)	B	27.9/24.7
R2024	7030005240	S.RES ERJ2GEJ 473 X (47K)	B	26.6/21.6
R2026	7030004970	S.RES ERJ2GEJ 470 X (47K)	B	27.9/22.9
R2028	7030005240	S.RES ERJ2GEJ 473 X (47K)	B	12.1/19.3
R2030	7030005240	S.RES ERJ2GEJ 473 X (47K)	B	11.0/21.2
R2031	7030005240	S.RES ERJ2GEJ 473 X (47K)	B	10.7/29.4
R2032	7030005240	S.RES ERJ2GEJ 473 X (47K)	B	24.9/17.4
R2034	7030005240	S.RES ERJ2GEJ 473 X (47K)	B	28.8/10.5
R2035	7030005240	S.RES ERJ2GEJ 473 X (47K)	B	26.7/14.9
R2036	7030004980	S.RES ERJ2GEJ 101 X (100)	T	26.8/11.9
R2037	7030007290	S.RES ERJ2GEJ 222 X (2.2K)	T	28.1/10.7
R2038	7030004970	S.RES ERJ2GEJ 470 X (47K)	B	28.8/12.1
R2039	7030005240	S.RES ERJ2GEJ 473 X (47K)	B	24.1/9.5
R2040	7030005240	S.RES ERJ2GEJ 473 X (47K)	B	24.5/12.1
R2043	7410001140	S.ARR EXB28V104JX	T	15.6/26.7
R2044	7410001140	S.ARR EXB28V104JX	T	20.8/26.6
R2045	7410001140	S.ARR EXB28V104JX	B	27.0/22.3
R2046	7410001140	S.ARR EXB28V104JX	T	19.3/26.7
R2047	7410001140	S.ARR EXB28V104JX	B	10.9/14.5
R2048	7030005090	S.RES ERJ2GEJ 104 X (100K)	T	25.7/14.6
R2049	7030005090	S.RES ERJ2GEJ 104 X (100K)	B	21.8/15.6
R2050	7410001140	S.ARR EXB28V104JX	B	22.6/18.2
R2051	7410001140	S.ARR EXB28V104JX	T	9.9/11.6
R2052	7030005090	S.RES ERJ2GEJ 104 X (100K)	T	16.8/11.7
R2053	7030005090	S.RES ERJ2GEJ 104 X (100K)	B	16.0/14.5
R2056	7030010040	S.RES ERJ2GEJ-JPW	T	10.6/20.0
R2057	7030005090	S.RES ERJ2GEJ 104 X (100K)	T	10.4/22.9
R2058	7410001140	S.ARR EXB28V104JX	B	17.0/18.6
R2059	7030005090	S.RES ERJ2GEJ 104 X (100K)	T	10.4/23.8
R2060	7030005090	S.RES ERJ2GEJ 104 X (100K)	T	25.7/16.6
R2061	7030005090	S.RES ERJ2GEJ 104 X (100K)	B	11.7/12.6
R2062	7030005090	S.RES ERJ2GEJ 104 X (100K)	B	17.7/14.4
R2063	7030005090	S.RES ERJ2GEJ 104 X (100K)	B	22.1/23.4
R2064	7030005090	S.RES ERJ2GEJ 104 X (100K)	B	19.7/17.7
R2065	7030005030	S.RES ERJ2GEJ 152 X (1.5K)	B	13.8/6.8
R2066	7410001170	S.ARR EXB28V104JX	T	21.3/6.7
R2067	7030010040	S.RES ERJ2GEJ-JPW	T	11.4/5.3
R2068	7030010040	S.RES ERJ2GEJ-JPW	T	20.9/10.4
R2071	7030010040	S.RES ERJ2GEJ-JPW	T	24.9/5.7
R2072	7030005050	S.RES ERJ2GEJ 103 X (10K)	B	12.2/10.1
R2074	7030010040	S.RES ERJ2GEJ-JPW	T	8.7/10.0
R2084	7030010040	S.RES ERJ2GEJ-JPW [EUR-01]	T	30.7/10.5
	7030010040	S.RES ERJ2GEJ-JPW [EXP-01]		
	7030010040	S.RES ERJ2GEJ-JPW [CHN-01]		
R2085	7030010040	S.RES ERJ2GEJ-JPW [EUR-01]	B	19.5/9.6
	7030010040	S.RES ERJ2GEJ-JPW [EXP-01]		
	7030010040	S.RES ERJ2GEJ-JPW [CHN-01]		
C1	4030011070	S.CER GRM31M2C2H5R0CY21L (GRM42-6 CH)	B	8.4/66.6
C2	4030011070	S.CER GRM31M2C2H5R0CY21L (GRM42-6 CH)	B	7.4/58.6
C3	4030009500	S.CER C1608 CH 1H 0R5B-T	B	25.6/51.9
C4	4030009500	S.CER C1608 CH 1H 0R5B-T	B	16.4/51.9
C5	4030009500	S.CER C1608 CH 1H 0R5B-T	B	8.2/54.5
C6	4030011090	S.CER GRM31M2C2H7R0DV01L (GRM42-6 CH)	B	7.4/56.3
C7	4030011070	S.CER GRM31M2C2H5R0CY21L (GRM42-6 CH)	B	13.1/60.7
C8	4030011070	S.CER GRM31M2C2H5R0CY21L (GRM42-6 CH)	B	19.5/60.7
C9	4030011080	S.CER GRM31M2C2H6R0DV01L (GRM42-6 CH)	T	30.6/53.1
C10	4030017730	S.CER C1005 JB 1H 471K-T	B	18.1/48.1
C11	4030017730	S.CER C1005 JB 1H 471K-T	B	10.0/49.2
C12	4030017730	S.CER C1005 JB 1H 471K-T	T	39.4/54.4
C13	4030017420	S.CER C1005 CH 1H 470J-T	B	49.5/51.4
C14	4030019420	S.CER GRM31A7U2102JW31D	B	34.9/55.5
C15	4030017570	S.CER C1005 CH 1H 040B-T [EUR-01]	T	23.7/50.4
	4030017380	S.CER C1005 CH 1H 050B-T [EXP-01]		
	4030017380	S.CER C1005 CH 1H 050B-T [USA-01]		
	4030017380	S.CER C1005 CH 1H 050B-T [EXP-03]		
	4030017380	S.CER C1005 CH 1H 050B-T [CHN-01]		
C20	4030017400	S.CER C1005 CH 1H 220J-T	B	30.6/40.5
C21	4030017590	S.CER C1005 CH 1H 070C-T	B	26.7/38.1
C22	4030017360	S.CER C1005 CH 1H 030B-T [EUR-01]	B	32.0/37.5
	4030017370			

[MAIN-A UNIT] (For [Low band] versions)

REF NO.	PARTS NO.	DESCRIPTION	M.	H/V LOCATION	
C45	4030017620	S.CER C1005 CH 1H 100C-T	B	55.5/42.0	
C48	4030017420	S.CER C1005 CH 1H 470J-T	B	72.2/40.6	
C49	4030017380	S.CER C1005 CH 1H 050B-T	B	75.9/39.2	
C50	4030017460	S.CER C1005 JB 1H 102K-T	B	73.1/40.6	
C51	4030017460	S.CER C1005 JB 1H 102K-T	T	72.4/41.1	
C52	4030017620	S.CER C1005 CH 1H 100C-T	B	70.4/41.2	
C53	4030016790	S.CER C1005 JB 1E 103K-T	B	71.3/42.8	
C54	4030017730	S.CER C1005 JB 1H 471K-T	B	70.4/42.8	
C57	4030017460	S.CER C1005 JB 1H 102K-T	B	74.6/36.7	
C58	4030017460	S.CER C1005 JB 1H 102K-T	T	67.2/26.1	
C59	4030017460	S.CER C1005 JB 1H 102K-T	T	66.9/22.7	
C60	4030016790	S.CER C1005 JB 1E 103K-T	T	65.3/26.6	
C61	4030017430	S.CER C1005 CH 1H 101J-T	T	61.6/23.1	
C62	4030017420	S.CER C1005 CH 1H 470J-T	B	57.1/24.3	
C63	4030017420	S.CER C1005 CH 1H 470J-T	T	60.3/14.3	
C64	4030016790	S.CER C1005 JB 1E 103K-T	B	56.2/26.8	
C65	4030018860	S.CER C1005 JB 0J 105K-T	T	58.2/19.6	
C66	4030017460	S.CER C1005 JB 1H 102K-T	T	54.7/19.9	
C67	4030017460	S.CER C1005 JB 1H 102K-T	B	58.4/21.3	
C68	4030017680	S.CER C1005 CH 1H 820J-T	T	52.2/23.8	
C69	4030017710	S.CER C1005 CH 1H 181J-T	T	54.0/23.8	
C70	4030017710	S.CER C1005 CH 1H 181J-T	T	54.0/25.6	
C71	4030016930	S.CER C1005 JB 1A 104K-T	T	57.4/29.0	
C72	4030017730	S.CER C1005 JB 1H 471K-T	[USA-01] [EXP-03] [CHN-01]	T	59.8/48.0
	4030017730	S.CER C1005 JB 1H 471K-T	[USA-01] [EXP-03] [CHN-01]	T	59.8/48.0
C74	4030017730	S.CER C1005 JB 1H 471K-T	B	11.2/50.5	
C75	4030019560	S.CER GRM21BB31C106KE15L	T	61.6/25.3	
C76	4030016790	S.CER C1005 JB 1E 103K-T	T	57.8/54.9	
C77	4030017460	S.CER C1005 JB 1H 102K-T	T	56.8/50.7	
C78	4030017730	S.CER C1005 JB 1H 471K-T	B	58.8/56.6	
C79	4030017900	S.CER C1005 JB 1E 123K-T	[EUR-01] [EXP-01]	T	62.4/55.0
	4030017900	S.CER C1005 JB 1E 123K-T	[EUR-01] [EXP-01]	T	62.4/55.0
	4030016960	S.CER C1005 JB 1E 183K-T	[USA-01] [EXP-03] [CHN-01]	T	61.4/48.3
	4030016960	S.CER C1005 JB 1E 183K-T	[USA-01] [EXP-03] [CHN-01]	T	61.4/48.3
	4030016960	S.CER C1005 JB 1E 183K-T	[USA-01] [EXP-03] [CHN-01]	T	61.4/48.3
C80	4030017780	S.CER C1005 JB 1H 472K-T	T	60.6/52.1	
C81	4030017460	S.CER C1005 JB 1H 102K-T	T	65.1/55.0	
C82	4030011030	S.CER GRM31M4C2H1R5CY21L (GRM42-6 CK)	T	34.9/65.2	
C84	4030017420	S.CER C1005 CH 1H 470J-T	T	55.0/61.6	
C85	4030017460	S.CER C1005 JB 1H 102K-T	T	56.0/61.6	
C86	4030017710	S.CER C1005 CH 1H 181J-T	T	81.3/63.8	
C87	4030017460	S.CER C1005 JB 1H 102K-T	T	79.8/68.8	
C88	4030017730	S.CER C1005 JB 1H 471K-T	T	64.6/52.1	
C89	4030017580	S.CER C1005 CH 1H 060C-T	B	87.3/57.5	
C90	4030017580	S.CER C1005 CH 1H 060C-T	B	88.2/57.5	
C92	4030017570	S.CER C1005 CH 1H 040B-T	B	89.9/58.0	
C93	4030017620	S.CER C1005 CH 1H 100C-T	B	86.9/51.5	
C96	4030017460	S.CER C1005 JB 1H 102K-T	B	87.8/56.3	
C97	4030017730	S.CER C1005 JB 1H 471K-T	B	87.8/55.4	
C98	4030017620	S.CER C1005 CH 1H 100C-T	B	83.5/48.7	
C99	4030017730	S.CER C1005 JB 1H 471K-T	B	81.4/48.3	
C100	4030017620	S.CER C1005 CH 1H 100C-T	B	91.2/34.9	
C102	4030017580	S.CER C1005 CH 1H 060C-T	[EUR-01] [EXP-01]	B	97.1/33.8
	4030017380	S.CER C1005 CH 1H 050B-T	[EXP-01] [USA-01]	B	97.1/33.8
	4030017380	S.CER C1005 CH 1H 050B-T	[EXP-01] [USA-01]	B	97.1/33.8
	4030017380	S.CER C1005 CH 1H 050B-T	[EXP-03] [CHN-01]	B	97.1/33.8
	4030017380	S.CER C1005 CH 1H 050B-T	[EXP-03] [CHN-01]	B	97.1/33.8
C103	4030017350	S.CER C1005 CH 1H 020B-T	[EUR-01] [EXP-01] [USA-01] [EXP-03] [CHN-01]	B	98.5/32.2
	4030017360	S.CER C1005 CH 1H 030B-T	[EXP-01] [USA-01] [EXP-03] [CHN-01]	B	98.5/32.2
	4030017360	S.CER C1005 CH 1H 030B-T	[EXP-01] [USA-01] [EXP-03] [CHN-01]	B	98.5/32.2
	4030017360	S.CER C1005 CH 1H 030B-T	[EXP-01] [USA-01] [EXP-03] [CHN-01]	B	98.5/32.2
C104	4030017460	S.CER C1005 JB 1H 102K-T	B	100.8/29.9	
C105	4030017730	S.CER C1005 JB 1H 471K-T	B	97.6/28.9	
C106	4030017420	S.CER C1005 CH 1H 470J-T	B	91.7/48.9	
C107	4030017460	S.CER C1005 JB 1H 102K-T	T	80.2/51.7	
C108	4030016790	S.CER C1005 JB 1E 103K-T	B	81.3/49.2	
C109	4030017460	S.CER C1005 JB 1H 102K-T	B	95.8/35.3	
C110	4030017730	S.CER C1005 JB 1H 471K-T	B	98.6/35.3	
C111	4030017730	S.CER C1005 JB 1H 471K-T	T	101.7/37.1	
C112	4030016930	S.CER C1005 JB 1A 104K-T	T	100.8/37.1	
C113	4030017540	S.CER C1005 CH 1H R75B-T	B	102.0/29.6	
C114	4030017610	S.CER C1005 CH 1H 090C-T	B	98.3/26.1	
C115	4030017400	S.CER C1005 CH 1H 220J-T	B	98.8/21.9	
C116	4030017460	S.CER C1005 JB 1H 102K-T	B	107.5/30.0	
C117	4030017730	S.CER C1005 JB 1H 471K-T	B	107.5/30.9	
C118	4030017520	S.CER C1005 CH 1H 0R3B-T	B	102.8/32.0	
C119	4030016790	S.CER C1005 JB 1E 103K-T	B	97.0/21.9	
C120	4030017730	S.CER C1005 JB 1H 471K-T	B	97.9/21.9	
C121	4030017590	S.CER C1005 CH 1H 070C-T	B	103.3/30.8	
C122	4030017390	S.CER C1005 CH 1H 180J-T	B	107.5/31.8	
C123	4030020040	S.CER C1005 CH 1H 200J-T	B	104.8/28.2	
C124	4030017400	S.CER C1005 CH 1H 220J-T	B	105.0/20.8	
C125	4030017420	S.CER C1005 CH 1H 470J-T	B	101.7/27.5	
C126	4030017610	S.CER C1005 CH 1H 090C-T	B	95.6/23.7	
C127	4030017410	S.CER C1005 CH 1H 240J-T	B	96.1/21.9	
C128	4030017360	S.CER C1005 CH 1H 030B-T	B	99.2/27.3	
C129	4030017530	S.CER C1005 CH 1H 0R5B-T	B	103.5/27.5	
C131	4030017350	S.CER C1005 CH 1H 020B-T	B	106.4/27.2	
C132	4030017460	S.CER C1005 JB 1H 102K-T	T	94.3/12.6	
C133	4030017620	S.CER C1005 CH 1H 100C-T	B	105.4/22.7	
C134	4030017620	S.CER C1005 CH 1H 100C-T	B	93.7/22.8	
C135	4030016790	S.CER C1005 JB 1E 103K-T	T	78.3/21.0	
C139	4030016930	S.CER C1005 JB 1A 104K-T	B	107.5/33.6	
C140	4030017430	S.CER C1005 CH 1H 101J-T	B	81.2/18.9	
C141	4030017460	S.CER C1005 JB 1H 102K-T	T	75.7/21.5	
C143	4030017460	S.CER C1005 JB 1H 102K-T	T	78.9/22.2	
C144	4030017420	S.CER C1005 CH 1H 470J-T	T	92.5/16.1	
C146	4550000560	S.TAN TEESVA 1V 334M8R	T	84.7/22.9	
C147	45500003250	S.TAN TEESVA 1V 474M8R	T	80.5/22.9	
C148	4030019560	S.CER GRM21BB31C106KE15L	T	109.7/30.5	
C151	4030016930	S.CER C1005 JB 1A 104K-T	B	75.3/18.1	
C152	4030017420	S.CER C1005 CH 1H 470J-T	B	77.8/18.1	

[MAIN-A UNIT] (For [Low band] versions)

REF NO.	PARTS NO.	DESCRIPTION	M.	H/V LOCATION	
C153	4030017420	S.CER C1005 CH 1H 470J-T	B	78.1/16.2	
C154	4030017420	S.CER C1005 CH 1H 470J-T	B	76.4/16.2	
C155	4030017460	S.CER C1005 JB 1H 102K-T	B	81.7/16.7	
C156	4030016790	S.CER C1005 JB 1E 103K-T	B	81.2/17.9	
C157	4030017620	S.CER C1005 CH 1H 100C-T	B	72.4/24.4	
C160	4030016930	S.CER C1005 JB 1A 104K-T	B	74.2/21.3	
C162	4030016790	S.CER C1005 JB 1E 103K-T	B	72.4/17.7	
C165	4030017460	S.CER C1005 JB 1H 102K-T	B	74.1/23.5	
C192	4030017360	S.CER C1005 CH 1H 030B-T	[EUR-01] [EXP-01] [USA-01] [EXP-03] [CHN-01]	B	34.3/40.5
	4030017350	S.CER C1005 CH 1H 020B-T	[EUR-01] [EXP-01] [USA-01] [EXP-03] [CHN-01]	B	34.3/40.5
	4030017350	S.CER C1005 CH 1H 020B-T	[EUR-01] [EXP-01] [USA-01] [EXP-03] [CHN-01]	B	34.3/40.5
	4030017350	S.CER C1005 CH 1H 020B-T	[EUR-01] [EXP-01] [USA-01] [EXP-03] [CHN-01]	B	34.3/40.5
C193	4030017340	S.CER C1005 CH 1H 010B-T	B	51.5/38.3	
C277	4030016930	S.CER C1005 JB 1A 104K-T	B	36.0/28.4	
C281	4030017770	S.CER C1005 JB 1H 332K-T	T	92.0/13.5	
C282	4030016930	S.CER C1005 JB 1A 104K-T	T	44.2/28.0	
C283	4030016930	S.CER C1005 JB 1A 104K-T	T	42.5/25.2	
C284	4030016930	S.CER C1005 JB 1A 104K-T	T	44.2/28.9	
C285	4030017580	S.CER C1005 CH 1H 060C-T	B	94.0/29.9	
C286	4030017600	S.CER C1005 CH 1H 080C-T	B	36.4/26.3	
C287	4030017460	S.CER C1005 JB 1H 102K-T	T	95.9/11.7	
C298	4030017630	S.CER C1005 CH 1H 120J-T	T	86.3/29.4	
C299	4030017570	S.CER C1005 CH 1H 040B-T	T	83.9/29.4	
C300	4030017350	S.CER C1005 CH 1H 020B-T	T	85.1/30.8	
C301	4030017730	S.CER C1005 JB 1H 471K-T	B	92.8/31.3	
C302	4030017420	S.CER C1005 CH 1H 470J-T	B	80.1/39.2	
C303	4030017730	S.CER C1005 JB 1H 471K-T	B	80.1/36.3	
C305	4030017500	S.CER C1005 CH 1H 560J-T	B	64.8/24.2	
C306	4030017580	S.CER C1005 CH 1H 060C-T	B	64.3/25.4	
C307	4030017500	S.CER C1005 CH 1H 560J-T	B	61.3/22.7	
C308	4030017360	S.CER C1005 CH 1H 030B-T	B	60.1/23.2	
C309	4030016790	S.CER C1005 JB 1E 103K-T	B	67.4/21.8	
C312	4030016930	S.CER C1005 JB 1A 104K-T	B	67.4/20.9	
C314	4030016790	S.CER C1005 JB 1E 103K-T	T	110.5/33.8	
C323	4030017620	S.CER C1005 CH 1H 100C-T	B	72.3/26.2	
C328	4030017560	S.CER C1005 CH 1H 2R5B-T	B	85.4/55.8	
C332	4030017530	S.CER C1005 CH 1H 0R5B-T	B	84.9/50.0	
C333	4030017420	S.CER C1005 CH 1H 470J-T	B	40.4/40.7	
C334	4030017590	S.CER C1005 CH 1H 070C-T	B	94.9/68.3	
C335	4030017630	S.CER C1005 CH 1H 120J-T	B	93.8/68.3	
C336	4030017710	S.CER C1005 CH 1H 181J-T	B	62.0/68.2	
C337	4030017460	S.CER C1005 JB 1H 102K-T	T	82.7/29.7	
C340	4030017710	S.CER C1005 CH 1H 181J-T	T	107.7/28.7	
C342	4550002980	S.TAN TEESVA 1C 225M8R	B	78.4/66.1	
C343	4030017460	S.CER C1005 JB 1H 102K-T	B	51.5/39.2	
C344	4030017460	S.CER C1005 JB 1H 102K-T	B	54.2/68.0	
C345	4030017730	S.CER C1005 JB 1H 471K-T	B	54.2/67.1	
C346	4030017420	S.CER C1005 CH 1H 470J-T	B	66.0/68.7	
C347	4030017460	S.CER C1005 JB 1H 102K-T	T	52.2/22.2	
C348	4030017460	S.CER C1005 JB 1H 102K-T	T	59.3/20.5	
C350	4030017920	S.CER C1005 JB 1A 683K-T	T	95.9/14.4	
C357	4030016930	S.CER C1005 JB 1A 104K-T	T	103.5/34.7	
C358	4030017340	S.CER C1005 CH 1H 010B-T	B	91.2/35.8	
C366	4030017460	S.CER C1005 JB 1H 102K-T	B	97.0/64.4	
C367	4030017730	S.CER C1005 JB 1H 471K-T	B	97.0/65.8	
C368	4030017420	S.CER C1005 CH 1H 470J-T	B	97.0/67.3	
C372	4030017730	S.CER C1005 JB 1H 471K-T	T	60.3/67.7	
C376	4030017730	S.CER C1005 JB 1H 471K-T	B	88.7/49.5	
C377	4030017460	S.CER C1005 JB 1H 102K-T	T	57.8/61.6	
C383	4030018860	S.CER C1005 JB 0J 105K-T	T	36.4/36.2	
C384	4030016930	S.CER C1005 JB 1A 104K-T	T	59.3/29.0	
C385	4030016930	S.CER C1005 JB 1A 104K-T	B	54.9/28.9	
C388	4030017730	S.CER C1005 JB 1H 471K-T	B	68.2/36.0	
C390	4030017460	S.CER C1005 JB 1H 102K-T	B	75.0/40.6	
C391	4030017420	S.CER C1005 CH 1H 470J-T	B	75.9/40.6	
C392	4030017530	S.CER C1005 CH 1H 0R5B-T	B		

[MAIN-A UNIT] (For [Low band] versions)

REF NO.	PARTS NO.	DESCRIPTION	M.	H/V LOCATION
C458	4030017420	S.CER C1005 CH 1H 470J-T	T	63.8/50.8
C459	4030017420	S.CER C1005 CH 1H 470J-T	T	86.1/48.4
C460	4030017420	S.CER C1005 CH 1H 470J-T	T	64.9/49.8
C463	4030017720	S.CER C1005 JB 1H 331K-T	T	54.0/26.5
C466	4030017420	S.CER C1005 CH 1H 470J-T	T	62.7/49.8
C467	4030017420	S.CER C1005 CH 1H 470J-T	T	88.4/10.4
C471	4030017420	S.CER C1005 CH 1H 470J-T	B	103.7/19.2
C494	4030018860	S.CER C1005 JB 0J 105K-T	T	37.3/36.2
C624	4030017460	S.CER C1005 JB 1H 102K-T	B	81.2/26.7
C625	4030019990	S.CER C1005 JB 1C 104K-T	B	63.3/16.4
C626	4030017430	S.CER C1005 CH 1H 101J-T	B	59.9/20.5
C627	4030018910	S.CER C1608 JB 0J 475K-T	B	57.7/19.6
C628	4030017590	S.CER C1005 CH 1H 070C-T	T	63.3/36.2
C629	4030017530	S.CER C1005 CH 1H 0R5B-T	T	66.8/29.7
C630	4030016790	S.CER C1005 JB 1E 103K-T	T	66.8/28.8
C631	4030016790	S.CER C1005 JB 1E 103K-T	T	68.6/41.6
C632	4030016790	S.CER C1005 JB 1E 103K-T	T	76.5/41.6
C633	4030016930	S.CER C1005 JB 1A 104K-T	T	81.3/43.1
C634	4030016930	S.CER C1005 JB 1A 104K-T	T	80.0/41.2
C635	4030016790	S.CER C1005 JB 1E 103K-T	T	71.5/29.7
C637	4030017600	S.CER C1005 CH 1H 080C-T	T	72.3/36.2
C638	4030017460	S.CER C1005 JB 1H 102K-T	T	83.5/42.2
C639	4030016930	S.CER C1005 JB 1A 104K-T	T	46.8/25.7
C640	4030017040	S.CER C1005 JB 1A 333K-T	B	38.8/24.4
C641	4030018890	S.CER C1005 JB 0J 224K-T	B	76.3/27.1
C642	4030018890	S.CER C1005 JB 0J 224K-T	B	77.5/27.0
C643	4030017430	S.CER C1005 CH 1H 101J-T	B	77.5/27.9
C644	4030019560	S.CER GRM21BB31C106KE15L	B	81.7/20.4
C645	4030016930	S.CER C1005 JB 1A 104K-T	B	30.0/15.7
C646	4030017460	S.CER C1005 JB 1H 102K-T	T	84.7/10.0
C647	4030016790	S.CER C1005 JB 1E 103K-T	B	59.1/27.7
C1003	4030017460	S.CER C1005 JB 1H 102K-T	T	133.3/63.5
C1005	4030018980	S.CER C1608 JB 1H 104K-T	B	100.1/11.8
C1007	4030017460	S.CER C1005 JB 1H 102K-T	T	100.1/12.1
C1008	4510009680	S.ELE EEEFK1E471P	B	110.2/52.6
C1010	4030017460	S.CER C1005 JB 1H 102K-T	B	106.5/59.0
C1011	4030016930	S.CER C1005 JB 1A 104K-T	B	93.9/12.1
C1012	4030017420	S.CER C1005 CH 1H 470J-T	B	117.5/16.6
C1014	4030017460	S.CER C1005 JB 1H 102K-T	T	116.6/27.5
C1015	4030017460	S.CER C1005 JB 1H 102K-T	T	114.9/8.0
C1017	4030017460	S.CER C1005 JB 1H 102K-T	B	122.5/64.9
C1018	4030017460	S.CER C1005 JB 1H 102K-T	T	133.3/45.0
C1019	4510009250	S.ELE EEEFK1C471P	B	130.5/34.8
C1022	4030017420	S.CER C1005 CH 1H 470J-T	B	105.5/59.0
C1023	4030017460	S.CER C1005 JB 1H 102K-T	B	113.4/58.8
C1024	4030017440	S.CER C1005 CH 1H 221J-T	B	113.4/59.7
C1025	4030017510	S.CER C1005 CH 1H 680J-T	T	113.4/60.6
C1026	4030019120	S.CER GRM188B31E105KA75D	B	115.8/49.1
C1028	4030017460	S.CER C1005 JB 1H 102K-T	B	117.4/6.1
C1029	4030017460	S.CER C1005 JB 1H 102K-T	T	114.9/12.6
C1031	4030017460	S.CER C1005 JB 1H 102K-T	T	115.0/16.9
C1032	4030016930	S.CER C1005 JB 1A 104K-T	B	123.6/16.6
C1033	4510009680	S.ELE EEEFK1E471P	B	120.0/29.1
C1034	4030018860	S.CER C1005 JB 0J 105K-T	B	131.6/16.6
C1035	4030016790	S.CER C1005 JB 1E 103K-T	B	131.6/18.7
C1036	4030018980	S.CER C1608 JB 1H 104K-T	T	128.4/46.9
C1037	4030019560	S.CER GRM21BB31C106KE15L	B	129.4/43.4
C1038	4030011600	S.CER C1608 JB 1E 104K-T	T	110.5/48.7
C1039	4510009680	S.ELE EEEFK1E471P	B	117.0/41.7
C1040	4030019560	S.CER GRM21BB31C106KE15L	B	116.7/22.2
C1042	4030016930	S.CER C1005 JB 1A 104K-T	B	118.1/22.4
C1043	4030016930	S.CER C1005 JB 1A 104K-T	T	114.9/16.0
C1045	4030017460	S.CER C1005 JB 1H 102K-T	T	114.9/14.2
C1046	4030018860	S.CER C1005 JB 0J 105K-T	T	114.9/15.1
C1048	4030018900	S.CER C1005 JB 0J 474K-T	B	122.7/18.6
C1050	4030018860	S.CER C1005 JB 0J 105K-T	B	125.2/16.6
C1051	4030017460	S.CER C1005 JB 1H 102K-T	B	122.1/48.2
C1052	4030016930	S.CER C1005 JB 1A 104K-T	T	127.8/40.1
C1053	4030019560	S.CER GRM21BB31C106KE15L	T	127.8/44.5
C1056	4030018860	S.CER C1005 JB 0J 105K-T	T	111.2/11.7
C1057	4030016930	S.CER C1005 JB 1A 104K-T	B	118.7/17.1
C1058	4030019560	S.CER GRM21BB31C106KE15L	T	105.5/44.4
C1059	4030017460	S.CER C1005 JB 1H 102K-T	T	107.7/46.3
C1060	4030017460	S.CER C1005 JB 1H 102K-T	B	126.2/39.8
C1061	4030017460	S.CER C1005 JB 1H 102K-T	T	107.7/37.4
C1062	4030017460	S.CER C1005 JB 1H 102K-T	B	120.7/22.9
C1063	4030019560	S.CER GRM21BB31C106KE15L	B	126.9/22.2
C1064	4030019560	S.CER GRM21BB31C106KE15L	B	121.6/36.0
C1065	4030017460	S.CER C1005 JB 1H 102K-T	B	120.2/35.6
C1066	4030018860	S.CER C1005 JB 0J 105K-T	B	125.6/38.1
C1070	4030017440	S.CER C1005 CH 1H 221J-T	B	120.4/16.2
C1071	4030016930	S.CER C1005 JB 1A 104K-T	B	120.4/10.8
C1074	4030017460	S.CER C1005 JB 1H 102K-T	B	73.9/10.4
C1075	4030017460	S.CER C1005 JB 1H 102K-T	B	70.7/14.4
C1076	4030017460	S.CER C1005 JB 1H 102K-T	B	69.7/14.4
C1077	4030017460	S.CER C1005 JB 1H 102K-T	B	68.8/14.4
C1080	4030016790	S.CER C1005 JB 1E 103K-T	B	51.1/15.3
C1081	4030016930	S.CER C1005 JB 1A 104K-T	B	117.2/15.2
C1082	4030016930	S.CER C1005 JB 1A 104K-T	B	114.8/14.6
C1083	4030017460	S.CER C1005 JB 1H 102K-T	T	37.6/19.3
C1084	4030017710	S.CER C1005 CH 1H 181J-T	B	41.9/20.8
C1085	4030017460	S.CER C1005 JB 1H 102K-T	T	76.3/14.6
C1092	4030016930	S.CER C1005 JB 1A 104K-T	B	75.8/14.4
C1095	4030016930	S.CER C1005 JB 1A 104K-T	T	38.5/19.3
C1096	4030018860	S.CER C1005 JB 0J 105K-T	T	51.7/18.5
C1097	4030018240	S.CER C1005 JB 1H 562K-T	B	50.8/17.8
C1098	4030018860	S.CER C1005 JB 0J 105K-T	T	54.5/16.3
C1099	4030018860	S.CER C1005 JB 0J 105K-T	B	45.2/20.8
C1100	4030017460	S.CER C1005 JB 1H 102K-T	B	75.8/9.1
C1101	4030017420	S.CER C1005 CH 1H 470J-T	T	78.2/8.0
	4030016930	S.CER C1005 JB 1A 104K-T	[EXP-01]	
	4030016930	S.CER C1005 JB 1A 104K-T	[USA-01]	
	4030016930	S.CER C1005 JB 1A 104K-T	[EXP-03]	
	4030016930	S.CER C1005 JB 1A 104K-T	[CHN-01]	

[MAIN-A UNIT] (For [Low band] versions)

REF NO.	PARTS NO.	DESCRIPTION	M.	H/V LOCATION
C1102	4030017420	S.CER C1005 CH 1H 470J-T	B	71.6/6.6
C1106	4030016930	S.CER C1005 JB 1A 104K-T	T	36.3/20.6
C1107	4030017440	S.CER C1005 CH 1H 221J-T	T	33.1/15.2
C1108	4030017450	S.CER C1005 JB 1H 271K-T	T	39.2/13.5
C1109	4030018860	S.CER C1005 JB 0J 105K-T	T	42.5/18.0
C1110	4030018860	S.CER C1005 JB 0J 105K-T	T	42.5/20.4
C1111	4030018860	S.CER C1005 JB 0J 105K-T	B	46.6/19.1
C1112	4030016930	S.CER C1005 JB 1A 104K-T	B	45.7/19.1
C1119	4030017420	S.CER C1005 CH 1H 470J-T	B	65.2/6.9
C1127	4030017660	S.CER C1005 CH 1H 330J-T	B	36.6/21.2
C1128	4030016930	S.CER C1005 JB 1A 104K-T	B	31.3/13.6
C1129	4030016930	S.CER C1005 JB 1A 104K-T	B	32.2/16.9
C1130	4030017900	S.CER C1005 JB 1E 123K-T	B	37.4/13.5
C1131	4550006970	S.TAN TEESVA0G476M8R	T	53.5/12.1
C1132	4030017460	S.CER C1005 JB 1H 102K-T	T	51.8/13.0
C1133	4030016790	S.CER C1005 JB 1E 103K-T	T	78.2/5.7
C1135	4030017460	S.CER C1005 JB 1H 102K-T	T	73.9/16.8
C1136	4030016930	S.CER C1005 JB 1A 104K-T	T	71.6/15.5
C1137	4030016780	S.CER C1005 JB 1E 153K-T	T	40.1/20.8
	4030016970	S.CER C1005 JB 1E 223K-T	[EUR-01]	
	4030016970	S.CER C1005 JB 1E 223K-T	[EXP-01]	
	4030016970	S.CER C1005 JB 1E 223K-T	[USA-01]	
	4030016970	S.CER C1005 JB 1E 223K-T	[EXP-03]	
	4030016970	S.CER C1005 JB 1E 223K-T	[CHN-01]	
C1138	4030017460	S.CER C1005 JB 1H 102K-T	T	37.7/15.7
C1139	4030017920	S.CER C1005 JB 1A 683K-T	T	54.5/17.2
C1140	4030017040	S.CER C1005 JB 1A 333K-T	B	52.0/18.3
C1141	4030016790	S.CER C1005 JB 1E 103K-T	B	42.4/17.3
C1142	4030016930	S.CER C1005 JB 1A 104K-T	B	117.6/11.8
C1143	4030018980	S.CER C1608 JB 1H 104K-T	B	93.8/9.4
C1144	4030016930	S.CER C1005 JB 1A 104K-T	B	41.7/15.1
C1145	4030018090	S.CER C1005 JB 1E 822K-T	B	42.8/20.8
C2001	4050000240	S.FEE NFM18PC104R1C3D	T	39.3/10.9
C2002	4030016930	S.CER C1005 JB 1A 104K-T	B	34.9/5.4
C2004	4550007730	S.TAN TEESVJ 0J 106M8R	B	35.3/7.2
C2007	4030018910	S.CER C1608 JB 0J 475K-T	B	18.4/10.7
C2008	4030016930	S.CER C1005 JB 1A 104K-T	B	16.1/8.9
C2009	4050000240	S.FEE NFM18PC104R1C3D	B	28.0/5.9
C2010	4050000240	S.FEE NFM18PC104R1C3D	B	12.3/5.5
C2011	4030019460	S.CER C1608 JB 0J 106M-T	T	33.0/6.9
C2012	4030016930	S.CER C1005 JB 1A 104K-T	B	26.4/5.8
C2013	4550007730	S.TAN TEESVJ 0J 106M8R	B	25.0/6.2
C2014	4030016930	S.CER C1005 JB 1A 104K-T	T	31.7/6.6
C2015	4030016930	S.CER C1005 JB 1A 104K-T	B	10.1/6.4
C2016	4550007720	S.TAN TEESVP 0G 476M8R	T	26.7/7.1
C2017	4550007730	S.TAN TEESVJ 0J 106M8R	B	17.2/9.2
C2018	4030016930	S.CER C1005 JB 1A 104K-T	B	9.2/6.4
C2019	4030016790	S.CER C1005 JB 1E 103K-T	B	14.8/19.3
C2021	4030018910	S.CER C1608 JB 0J 475K-T	B	16.0/21.6
C2022	4030018910	S.CER C1608 JB 0J 475K-T	B	13.5/14.5
C2023	4030016790	S.CER C1005 JB 1E 103K-T	B	23.1/14.3
C2024	4030018860	S.CER C1005 JB 0J 105K-T	B	21.2/14.1
C2025	4030017420	S.CER C1005 CH 1H 470J-T	B	20.8/11.1
C2026	4030017460	S.CER C1005 JB 1H 102K-T	B	20.8/10.2
C2027	4030018860	S.CER C1608 JB 0J 475K-T	B	10.9/10.0
C2028	4030018910	S.CER C1005 JB 0J 105K-T	T	11.5/10.2
C2031	4030018860	S.CER C1005 JB 0J 105K-T	T	20.9/11.3
C2032	4030016930	S.CER C1005 JB 1A 104K-T	T	13.1/11.7
C2033	4030018860	S.CER C1005 JB 0J 105K-T	B	15.1/17.7
C2034	4030016930	S.CER C1005 JB 1A 104K-T	T	11.9/9.7
C2035	4030018910	S.CER C1608 JB 0J 475K-T	T	10.2/8.2
C2036	4030018860	S.CER C1005 JB 0J 105K-T	B	21.1/20.9
C2038	4030016790	S.CER C1005 JB 1E 103K-T	B	16.4/25.3
C2039	4030017430	S.CER C1005 CH 1H 101J-T	B	19.7/7.5
C2040	4030016790	S.CER C1005 JB 1E 103K-T	T	26.4/18.1
C2041	4030018910	S.CER C1608 JB 0J 475K-T	T	11.1/14.5
C2042	4030016930	S.CER C1005 JB 1A 104K-T	T	10.1/14.8
C2044	4030016930	S.CER C1005 JB 1E 103K-T	T	26.4/19.9
C2045	4030016930	S.CER C1005 JB 1A 104K-T	B	26.6/23.4
C2046	4030016930	S.CER C1005 JB 1A 104K-T	B	26.6/24.3
C2047	4			

[MAIN-A UNIT] (For [Low band] versions)

REF NO.	PARTS NO.	DESCRIPTION	M.	H/V LOCATION
J1001	6510014961	S.CON B2B-ZR-SM4-TF(LF)(SN)	T	130.5/27.3
J1002	6450000140	CON HSJ0807-01-010	T	120.0/17.2
J1003	6510022891	S.CON B13B-ZR-SM4-TF(LF)(SN)	T	67.5/10.6
J1004	6510027960	S.CON 04-6294-040-000-800	T	
S1001	2260003180	S.SWI MINISMDC050F-2 CN	T	114.1/33.8
W1	7030012290	JUM RDS2T0R0		
W2	8900011863	CAB OPC-1195C <TJM>		
EP1	6910018460	S.BEA MMZ1005Y102C-T	B	107.5/32.7
EP4	6910010280	BEA HF70BB9.5X10.4X4.9		
EP5	6910010280	BEA HF70BB9.5X10.4X4.9		
EP7	6910018460	S.BEA MMZ1005Y102C-T	B	74.2/19.4
EP8	6910018460	S.BEA MMZ1005Y102C-T	B	80.8/16.7
EP13	6910018460	S.BEA MMZ1005Y102C-T	B	100.1/25.3
EP14	6910011560	BEA HF70BB4.5X5X1.6		
EP15	6910011560	BEA HF70BB4.5X5X1.6		
EP2001	6910016330	S.BEA MMZ1005S 601CT-S	B	22.8/5.3
EP2003	6910016330	S.BEA MMZ1005S 601CT-S	T	9.1/7.0
EP2004	6910016330	S.BEA MMZ1005S 601CT-S	T	32.7/9.0
EP2005	6910016330	S.BEA MMZ1005S 601CT-S	B	24.6/23.8
EP2007	6910016330	S.BEA MMZ1005S 601CT-S	T	10.8/6.2

[MAIN-B UNIT] (For [High band] versions)

REF NO.	PARTS NO.	DESCRIPTION	M.	H/V LOCATION
IC2	1110002751	S.IC TA75S01F(TE85RF)	T	60.0/54.9
IC3	1150002390	IC RA30H4452M1-101 [EXP-02]		
	1150002410	IC RA60H4452M1-121 [USA-02]		
	1150002410	IC RA60H4452M1-121 [EXP-04]		
IC4	1110007320	S.IC NJM2591V-TE1-#ZZZB	T	57.8/24.7
IC5	1110006230	S.IC NJM2711F-TE1-#ZZZB	B	38.8/27.0
IC6	1110002751	S.IC TA75S01F(TE85RF)	B	59.9/17.4
IC7	1130011741	S.IC TC7W66FK(TE85LF)	T	85.8/12.3
IC8	1130015270	S.IC AK1541P-L	B	78.2/23.7
IC1001	1180003660	S.REG XC6408EN22PR-G	B	96.9/10.8
IC1002	1180003500	S.REG NJM7808DL1A-TE1-#FZZB	T	123.3/45.7
IC1004	1110002751	S.IC TA75S01F(TE85RF)	B	119.7/13.0
IC1005	1110007630	S.IC NJM2783V-TE1-#ZZZH	T	47.4/18.9
IC1006	1110007290	S.IC AK230P-L	B	53.7/11.5
IC1007	1110005320	S.IC NJM13403V-TE1-#ZZZB	B	37.4/17.0
IC1008	1130009981	S.IC TC7W53FK(TE85LF)	T	40.3/19.7
IC1009	1110003091	IC LA4425A-E		
IC2001	1180003680	S.REG TPS62204DBVR	B	32.4/6.5
IC2002	1190002900	S.IC ADS7886SDCKR	B	14.4/9.3
IC2006	1110007770	S.IC PCM3008T/2K	T	16.3/8.3
IC2007	1140013290	S.IC TMS320VC5509AZHH	T	18.0/18.4
IC2008	1130015620	S.IC EN25Q40-100GIP <MSK>	B	12.5/25.3
IC2009	1110006230	S.IC NJM2711F-TE1-#ZZZB	B	26.7/12.7
IC2010	1180003600	S.REG NJM2871BF05-TE1-#ZZZB	B	39.0/6.8
Q1	1590004090	S.TRA LDTC114YET1G <SLVJ>	B	47.2/27.1
Q2	1580000731	S.FET 3SK293(TE85LF)	B	41.5/38.7
Q3	1560000541	S.FET 2SK880-Y(T5RICOMF)	T	77.2/24.5
Q4	1530002851	S.TRA 2SC4116-BL(TE85RF)	B	67.9/25.4
Q5	1530002851	S.TRA 2SC4116-BL(TE85RF)	T	44.9/25.3
Q6	1590004090	S.TRA LDTC114YET1G <SLVJ>	T	62.2/52.2
Q7	1560000841	S.FET 2SK1829(TE85RF)	T	33.7/39.7
Q8	1530002680	S.TRA 2SC3357-T1	B	90.4/52.8
Q9	1560001360	S.FET 2SK3019 TL	T	52.2/26.3
Q10	1530003311	S.TRA 2SC5107-O(TE85RF)	B	92.8/33.1
Q11	1530003311	S.TRA 2SC5107-O(TE85RF)	B	100.5/31.7
Q12	1530004110	S.TRA MT3S37T(TE85LF)	B	97.6/30.4
Q13	1590004090	S.TRA LDTC114YET1G <SLVJ>	B	57.6/27.2
Q14	1530003311	S.TRA 2SC5107-O(TE85RF)	T	64.8/24.9
Q15	1590004500	S.TRA DMC561040R	T	101.0/34.4
Q17	1530002851	S.TRA 2SC4116-BL(TE85RF)	T	107.7/33.4
Q18	1590004090	S.TRA LDTC114YET1G <SLVJ>	T	81.5/40.8
Q19	1580000731	S.FET 3SK293(TE85LF)	B	71.4/38.4
Q20	1530002851	S.TRA 2SC4116-BL(TE85RF) [USA-02]	T	60.0/49.8
	1530002851	S.TRA 2SC4116-BL(TE85RF) [EXP-04]		
Q21	1590004090	S.TRA LDTC114YET1G <SLVJ>	B	49.5/24.8
Q23	1530002921	S.TRA 2SC4226-T1 Y25 (R25)	T	105.2/30.9
Q24	1530002921	S.TRA 2SC4226-T1 Y25 (R25)	B	98.3/24.2
Q25	1530003260	S.TRA 2SC5006-T1	B	84.9/51.5
Q1001	1590004090	S.TRA LDTC114YET1G <SLVJ>	T	110.6/44.1
Q1003	1550000190	S.FET 2SJ506STR-E	T	115.3/45.4
Q1004	1590004090	S.TRA LDTC114YET1G <SLVJ>	T	114.0/26.7
Q1005	1590004090	S.TRA LDTC114YET1G <SLVJ>	T	114.0/24.7
Q1007	1590004090	S.TRA LDTC114YET1G <SLVJ>	B	116.3/8.1
Q1008	1590000990	S.TRA DTC363EK T146	B	128.9/17.8
Q1009	1590001451	S.FET 2SJ144-GR (TE85RF)	B	113.8/11.1
Q1010	1590004090	S.TRA LDTC114YET1G <SLVJ>	B	116.1/10.9
Q1011	1540000550	S.TRA 2SD1664 T100Q	B	125.1/47.6
Q1012	1590004090	S.TRA LDTC114YET1G <SLVJ>	B	130.9/20.7
Q1013	1510000920	S.TRA 2SA1577 T106 Q	T	107.7/44.3
Q1014	1520000460	S.TRA 2SB1132 T100 R	B	123.5/21.1
Q1015	1590004590	S.TRA DMC506010R	B	118.9/20.4
Q1016	1590004090	S.TRA LDTC114YET1G <SLVJ>	T	107.8/39.2
Q1017	1520000460	S.TRA 2SB1132 T100 R	T	120.1/35.2
Q1018	1590004090	S.TRA LDTC114YET1G <SLVJ>	B	126.4/43.3
Q1019	1590004590	S.TRA DMC506010R	B	123.8/35.8
Q1020	1590004090	S.TRA LDTC114YET1G <SLVJ>	T	42.6/22.5
Q1021	1590004090	S.TRA LDTC114YET1G <SLVJ>	B	126.4/41.3
Q2001	1590004040	S.TRA LDTC114YET1G <SLVJ>	B	26.9/26.6
D2	1750001910	S.DIO HVD144AKRF-E	B	52.6/28.5
D3	1750001910	S.DIO HVD144AKRF-E	B	52.6/27.3
D4	1750000711	S.VAR HVC350BTRF-E	B	36.0/40.2
D5	1750002060	S.DIO RN752TE-21	T	26.5/53.3
D7	1750001910	S.DIO HVD144AKRF-E	B	25.3/45.3
D8	1750001910	S.DIO HVD144AKRF-E	B	43.4/27.3
D9	1750001910	S.DIO HVD144AKRF-E	B	43.4/28.6
D10	1750000711	S.VAR HVC350BTRF-E	B	55.5/39.9
D11	1750001820	S.DIO LRB706F-40T1G <SLVJ>	B	8.2/49.9
D12	1750001820	S.DIO LRB706F-40T1G <SLVJ>	B	22.8/49.9
D13	1750001910	S.DIO HVD144AKRF-E	T	68.3/28.1
D14	1750001910	S.DIO HVD144AKRF-E	T	69.5/28.1
D15	1790001261	S.DIO MA2S077GOL	B	82.2/39.2
D16	1750000711	S.VAR HVC350BTRF-E	B	106.7/20.3
D17	1750001910	S.DIO HVD144AKRF-E	T	70.6/41.6
D18	1750001910	S.DIO HVD144AKRF-E	T	74.5/41.6
D19	1750000711	S.VAR HVC350BTRF-E	B	61.9/39.9
D20	1750000711	S.VAR HVC350BTRF-E	B	28.0/40.2
D21	1750000711	S.VAR HVC350BTRF-E	B	36.0/41.6
D22	1750000711	S.VAR HVC350BTRF-E	B	28.0/41.6
D23	1750000711	S.VAR HVC350BTRF-E	B	52.8/42.6
D24	1750002060	S.DIO RN752TE-21	T	35.1/56.7
D25	1750000581	S.DIO 1SV307(TPH3F)	B	83.5/42.1
D26	1750001650	S.VAR 1SV309(TPH3F)	B	101.8/25.9
D29	1750001820	S.DIO LRB706F-40T1G <SLVJ>	B	19.2/49.9
D33	1750000711	S.VAR HVC350BTRF-E	B	97.8/20.5
D62	1750000711	S.VAR HVC350BTRF-E	B	91.7/22.8
D64	1750000711	S.VAR HVC350BTRF-E	B	106.7/21.5
D66	1750000370	S.DIO DA221 TL	T	33.7/37.1
D67	1750002170	S.DIO DB2S31400L	T	31.8/39.7
D1002	1790000700	DIO DSA3A1		
D1003	1750000370	S.DIO DA221 TL	B	114.0/8.2
D1004	1750000370	S.DIO DA221 TL	B	114.1/6.1

M.=Mounted side (T: Mounted on the Top side, B: Mounted on the Bottom side)
S.=Surface mount

[MAIN-B UNIT] (For [High band] versions)

REF NO.	PARTS NO.	DESCRIPTION	M.	H/V LOCATION
D1005	1750000370	S.DIO DA221 TL	T	113.2/7.4
D1006	1750000370	S.DIO DA221 TL	T	113.0/10.3
D1007	1750001810	S.DIO L1SS400T1G <SLVJ>	B	129.0/20.7
D1008	1750000370	S.DIO DA221 TL	B	124.0/43.3
D2002	1750002170	S.DIO DB2S31400L	T	24.9/18.0
D2003	1750002170	S.DIO DB2S31400L	B	10.7/30.5
D2004	1750002170	S.DIO DB2S31400L	B	22.1/21.4
D2005	1750002170	S.DIO DB2S31400L	B	17.5/26.3
D2006	1750002170	S.DIO DB2S31400L	T	12.0/25.3
D2008	1750002020	S.DIO DA2S10100L	T	100.3/6.5
F11	2020002570	CER LTM450HW <JJE>		
F12	2020002410	CER LTM450FW <JJE>		
F13	2020002610	S.CER LTUCG450G <JJE>	T	36.3/28.0
F14	2030000870	S.MON MFT46.3P3 46.350 MHz (FL-442)	T	66.9/34.9
F15	2010002760	S.XTA MFT46.3J 46.350 MHz (FL-448)	T	75.8/34.9
F16	2040001440	S.LC NFE31PT152Z1E9L (NFM60R20T152)	B	97.7/62.2
F17	2040001440	S.LC NFE31PT152Z1E9L (NFM60R20T152)	B	97.7/58.9
F18	2040001440	S.LC NFE31PT152Z1E9L (NFM60R20T152) [USA-02]	B	97.7/55.4
	2040001440	S.LC NFE31PT152Z1E9L (NFM60R20T152) [EXP-04]		
X1	6070000300	S.DIS JTBM450CX24 <JJE>	B	51.4/22.5
X2	6050013000	S.XTA CR-892 TT514VSB-A8 15.3 MHz	B	71.5/21.0
X2001	6050013170	S.XTA CR-914 TT518VSE-A11 12.288 MHz	B	27.0/18.2
L1	6200010150	S.COI AS080340-15N	B	8.4/62.7
L2	6200010150	S.COI AS080340-15N	B	12.9/55.5
L3	6200010150	S.COI AS080340-15N	B	20.7/55.5
L4	6200013100	S.COI 0.45-1.5-STL 18.3N <COMO>	T	31.1/50.5
L5	6200010420	S.COI FHW1210HC 1R0JGT <JJE>	T	38.5/58.4
L6	6200010150	S.COI AS080340-15N	B	27.3/55.5
L7	6200012870	S.COI 0.30-1.4-5TR 23.5N <COMO>	B	28.8/37.8
L8	6200012870	S.COI 0.30-1.4-5TR 23.5N <COMO>	B	35.2/37.8
L9	6200012170	S.COI MLG1608S R18J-T	B	65.8/24.7
L10	6200011460	S.COI C2520C 10NG-A	B	49.0/39.8
L11	6200011460	S.COI C2520C 10NG-A	B	57.8/40.5
L12	6200012170	S.COI MLG1608S R18J-T	B	62.3/22.4
L13	6200007901	S.COI ELJRF 22NJFB	T	85.1/29.9
L16	6200010150	S.COI AS080340-15N	B	38.2/65.2
L18	6200005681	S.COI ELJRE 15NGFA	B	88.1/58.9
L19	6200005701	S.COI ELJRE 22NGFA	B	89.9/56.0
L20	6200010090	S.COI ELJND R82JF	B	68.9/40.9
L21	6200005701	S.COI ELJRE 22NGFA	B	90.8/33.1
L22	6200005701	S.COI ELJRE 22NGFA	B	99.5/33.8
L23	6200005661	S.COI ELJRE 10NGFA	B	84.9/53.2
L27	6200007370	S.COI ELJFC R82K-F	B	103.2/21.4
L28	6200011860	S.COI LQW18ANR47G00D	T	94.7/17.3
L36	6200006991	S.COI ELJRE 56NGFA	B	73.5/38.5
L37	6200006981	S.COI ELJRE 10NGFA	T	82.6/62.9
L38	6200014300	S.COI C36-4.7J <COMO>	B	106.2/24.9
L39	6200013710	S.COI C36-8NH <COMO>	B	92.9/20.2
L41	6200005711	S.COI ELJRE 27NGFA	B	95.8/29.8
L53	6200005721	S.COI ELJRE 33NGFA	B	78.0/39.2
L54	6200007370	S.COI ELJFC R82K-F	T	100.0/30.4
L55	6200002851	S.COI NLV25T-R82J	B	103.7/33.8
L56	6200011460	S.COI C2520C 10NG-A	B	64.2/40.5
L57	6200011860	S.COI LQW18ANR47G00D	B	92.6/24.0
L58	6200011860	S.COI LQW18ANR47G00D	B	105.9/19.3
L1001	6200004660	S.COI MLF1608A 1R8K-T	T	79.8/13.1
L2001	6200014160	S.COI VLCF4028T-100M1R0-2	T	35.9/7.6
L2002	6200007830	S.COI ELJFC 4R7K-F	B	31.2/11.2
R1	7030000620	S.RES MCR10EZHZ 100 K (104)	B	12.3/65.5
R4	7030003560	S.RES ERJ3GEYJ 103 V (10K)	B	16.4/50.6
R5	7030005220	S.RES ERJ2GEJ 223 X (22K)	B	11.2/49.6
R6	7030005220	S.RES ERJ2GEJ 223 X (22K)	B	19.8/48.1
R7	7030003560	S.RES ERJ3GEYJ 103 V (10K)	B	8.2/53.2
R8	7030006070	S.RES ERJ12YJ101U (100)	B	45.7/51.9
R9	7030003560	S.RES ERJ3GEYJ 103 V (10K)	B	25.6/50.6
R10	7030005220	S.RES ERJ2GEJ 223 X (22K)	B	22.2/48.1
R11	7030005050	S.RES ERJ2GEJ 103 X (10K)	B	31.5/40.5
R12	7030004980	S.RES ERJ2GEJ 101 X (100)	B	39.2/39.5
R13	7030005050	S.RES ERJ2GEJ 103 X (10K)	B	32.5/40.5
R14	7030005050	S.RES ERJ2GEJ 103 X (10K)	B	32.5/38.8
R15	7030005700	S.RES ERJ2GEJ 274 X (270K)	B	39.2/38.6
R16	7030004990	S.RES ERJ2GEJ 221 X (220) [EXP-02]	B	39.5/40.7
	7030004980	S.RES ERJ2GEJ 101 X (100) [USA-02]		
	7030004980	S.RES ERJ2GEJ 101 X (100) [EXP-04]		
R17	7030005530	S.RES ERJ2GEJ 100 X (10)	B	51.5/40.2
R18	7030005050	S.RES ERJ2GEJ 103 X (10K)	B	60.8/40.5
R19	7030005090	S.RES ERJ2GEJ 104 X (100K)	B	39.2/36.8
R20	7030005120	S.RES ERJ2GEJ 102 X (1K)	B	52.8/38.6
R21	7030005050	S.RES ERJ2GEJ 103 X (10K)	B	54.1/40.2
R22	7030005050	S.RES ERJ2GEJ 103 X (10K)	B	56.2/37.4
R23	7030005050	S.RES ERJ2GEJ 103 X (10K)	B	54.1/41.2
R29	7030005570	S.RES ERJ2GEJ 820 X (82)	B	74.0/40.6
R30	7030007300	S.RES ERJ2GEJ 332 X (3.3K)	B	71.3/41.2
R31	7030004980	S.RES ERJ2GEJ 101 X (100)	B	66.9/37.4
R33	7030005600	S.RES ERJ2GEJ 273 X (27K)	T	71.9/42.7
R34	7030005110	S.RES ERJ2GEJ 224 X (220K)	T	64.9/23.1
R35	7030005530	S.RES ERJ2GEJ 100 X (10)	T	64.9/22.2
R36	7030005030	S.RES ERJ2GEJ 152 X (1.5K)	B	56.2/21.7
R37	7030008400	S.RES ERJ2GEJ 182 X (1.8K)	B	56.6/25.5
R38	7030005090	S.RES ERJ2GEJ 104 X (100K)	T	61.7/17.8
R39	7030004970	S.RES ERJ2GEJ 470 X (47)	B	58.4/22.2
R40	7030005030	S.RES ERJ2GEJ 152 X (1.5K)	B	58.4/23.2

[MAIN-B UNIT] (For [High band] versions)

REF NO.	PARTS NO.	DESCRIPTION	M.	H/V LOCATION
R41	7030010040	S.RES ERJ2GEJ-JPW	T	60.8/17.8
R42	7030005070	S.RES ERJ2GEJ 683 X (68K)	T	51.0/24.3
R43	7030005000	S.RES ERJ2GEJ 471 X (470)	T	55.6/19.9
R44	7030005310	S.RES ERJ2GEJ 124 X (120K)	T	54.0/24.7
R45	7030005310	S.RES ERJ2GEJ 124 X (120K)	T	52.2/24.7
R46	7030008410	S.RES ERJ2GEJ 392 X (3.9K)	T	54.0/22.9
R48	7030008300	S.RES ERJ2GEJ 184 X (180K) [USA-02]	T	56.8/53.2
	7030008300	S.RES ERJ2GEJ 184 X (180K) [EXP-04]		
R49	7520000241	S.POS PRF18BC471QB5RB [USA-02]	T	47.3/53.2
	7520000241	S.POS PRF18BC471QB5RB [EXP-04]		
R50	7030005050	S.RES ERJ2GEJ 103 X (10K)	B	80.1/37.9
R51	7030005220	S.RES ERJ2GEJ 223 X (22K)	T	61.8/49.8
	7030005080	S.RES ERJ2GEJ 823 X (82K) [EXP-02]		
	7030005080	S.RES ERJ2GEJ 823 X (82K) [USA-02]		
	7030005080	S.RES ERJ2GEJ 823 X (82K) [EXP-04]		
R52	7030005070	S.RES ERJ2GEJ 683 X (68K)	T	58.7/52.1
R53	7030004990	S.RES ERJ2GEJ 221 X (220)	T	57.8/53.2
R54	7030005220	S.RES ERJ2GEJ 223 X (22K)	T	58.8/55.7
R56	7030005110	S.RES ERJ2GEJ 224 X (220K)	T	63.3/55.0
R57	7030005050	S.RES ERJ2GEJ 103 X (10K)	B	58.8/54.8
R58	7030005570	S.RES ERJ2GEJ 820 X (82)	T	64.2/55.0
R59	7030007350	S.RES ERJ2GEJ 393 X (39K)	T	59.7/52.1
R61	7030004970	S.RES ERJ2GEJ 470 X (47)	B	90.5/49.5
R62	7030008290	S.RES ERJ2GEJ 183 X (18K)	B	89.6/49.5
R66	7030005090	S.RES ERJ2GEJ 104 X (100K)	B	84.9/49.1
R67	7030004980	S.RES ERJ2GEJ 101 X (100)	B	83.0/47.3
R68	7030005050	S.RES ERJ2GEJ 103 X (10K)	B	82.6/48.7
R69	7030005040	S.RES ERJ2GEJ 472 X (4.7K)	B	84.0/38.0
R70	7030004990	S.RES ERJ2GEJ 221 X (220)	B	92.8/35.8
R71	7030007260	S.RES ERJ2GEJ 330 X (33)	B	95.3/38.8
R72	7030004980	S.RES ERJ2GEJ 101 X (100)	B	86.5/49.1
R73	7030004980	S.RES ERJ2GEJ 101 X (100)	B	99.5/35.3
R74	7030005080	S.RES ERJ2GEJ 823 X (82K)	B	101.3/33.7
R75	7030005720	S.RES ERJ2GEJ 563 X (56K)	B	97.6/32.2
R76	7030005030	S.RES ERJ2GEJ 152 X (1.5K)	B	96.7/32.2
R77	7030005120	S.RES ERJ2GEJ 102 X (1K)	T	105.6/36.0
R78	7030009270	S.RES ERJ2GEJ 821 X (820)	T	102.5/32.5
R79	7030006020	S.RES RR0510P-682-D (6.8K)	B	96.5/23.7
R80	7030009270	S.RES ERJ2GEJ 821 X (820)	T	100.0/32.5
R83	7030006020	S.RES RR0510P-682-D (6.8K)	B	106.4/29.1
R84	7030006020	S.RES RR0510P-682-D (6.8K)	B	106.4/28.2
R85	7030006020	S.RES RR0510P-682-D (6.8K)	B	95.6/25.3
R86	7030005110	S.RES ERJ2GEJ 224 X (220K)	B	102.6/24.4
R87	7030005530	S.RES ERJ2GEJ 100 X (10)	B	102.6/27.5
R89	7030005050	S.RES ERJ2GEJ 103 X (10K)	T	79.0/25.0
R90	7030005170	S.RES ERJ2GEJ 474 X (470K)	T	95.9/15.3
R92	7030005100	S.RES ERJ2GEJ 154 X (150K)	T	94.3/14.4
R93	7030005600	S.RES ERJ2GEJ 273 X (27K)	B	81.3/25.8
R95	7030005710	S.RES ERJ2GEJ 121 X (120)	B	83.8/24.5
R96	7030008400	S.RES ERJ2GEJ 182 X (1.8K)	B	83.8/23.5
R97	7030010040	S.RES ERJ2GEJ-JPW	B	82.2/24.5
R98	7030007290	S.RES ERJ2GEJ 222 X (2.2K)	T	109.5/33.8
R100	7030005240	S.RES ERJ2GEJ 473 X (47K)	T	76.1/20.3
R101	7030004980	S.RES ERJ2GEJ 101 X (100)	T	77.9/22.2
R123	7030005530	S.RES ERJ2GEJ 100 X (10)	T	68.2/40.2
R125	7030008370	S.RES ERJ2GEJ 561 X (560)	T	65.6/29.4
R171	7030004980	S.RES ERJ2GEJ 101 X (100)	T	45.5/28.6
R172	7030008300	S.RES ERJ2GEJ 184 X (180K)	T	44.2/27.1
R173	7030005120	S.RES ERJ2GEJ 102 X (1K)	T	42.9/26.4
R174	7030005290	S.RES ERJ2GEJ 682 X (6.8K)	T	42.0/28.7
R175	7030009290	S.RES ERJ2GEJ 562 X (5.6K)	T	41.6/27.8
R176	7030005030	S.RES ERJ2GEJ 152 X (1.5K)	T	40.2/26.4
R178	7030004970	S.RES ERJ2GEJ 470 X (47)	B	39.8/24.4
R211	7030004970	S.RES ERJ2GEJ 470 X (47)	T	82.7/28.3
R212	7030010040	S.RES ERJ2GEJ-JPW	T	82.6/60.4
R234	7030005070	S.RES ERJ2GEJ 683 X (68K)	B	92.8/34.9
R235	7030004980	S.RES ERJ2GEJ 101 X (100)	B	81.0/37.9
R236	7030007570	S.RES ERJ2GEJ 122 X (1.2K)	B	67.4/22.7
R237	7030007060	S.RES ERJ2GEJ 684X (680K)	B	67.4/23.6
R289	7030005240	S.RES ERJ2GEJ 473 X (47K)	T	95.9/12.6
R290	7030005010	S.RES ERJ2GEJ 681 X (680)	T	63.2/23.1
R291	7030005090	S.RES ERJ2GEJ 104 X (100K)	T	94.3/13.5
R293	7030006610	S.RES ERJ2GEJ 394 X (390K)	T	88.4/12.0
R295	7030006610	S.RES ERJ2GEJ 394 X (390K)	T	101.0/17.3
R299	7030008300	S.RES ERJ2GEJ 184 X (180K)	B	74.6/38.5
R300	7030005720	S.RES ERJ2GEJ 563 X (56K)	B	76.8/40.6
R301	7030005100	S.RES ERJ2GEJ 154 X (150K)	B	67.5/40.5
R302	7030005720	S.RES ERJ2GEJ 563 X (56K)	B	66.9/38.3
R308	7030009140	S.RES ERJ2GEJ 272 X (2.7K)	T	56.9/54.9
R311	7030010040	S.RES ERJ2GEJ-JPW	B	94.9/32.2
R317	7030005120	S.RES ERJ2GEJ 102 X (1K)	T	105.6/37.4
R319	7030007340	S.RES ERJ2GEJ 153 X (15K)	T	37.3/37.9
R320	7030005170	S.RES ERJ2GEJ 474 X (470K)	T	35.5/36.2
R328	7030010040	S.RES ERJ2GEJ-JPW	B	104.8/29.1
R334	7030009280	S.RES ERJ2GEJ 391 X	T	87.6/61.3
R337	7030010430	S.RES ERJ2GEJ 120 X (12)	T	87.1/62.7
R338	7030009280	S.RES ERJ2GEJ 391 X	T	87.6/64.1
R339	7030010040	S.RES ERJ2GEJ-JPW	B	96.5/25.3
R340	7030005050	S.RES ERJ2GEJ 103 X (10K)	B	72.4/25.3
R350	7030005600	S.RES ERJ2GEJ 273 X (27K)	B	52.9/26.2
R351	7030005600	S.RES ERJ		

[MAIN-B UNIT] (For [High band] versions)

REF NO.	PARTS NO.	DESCRIPTION	M.	H/V LOCATION
R500	7030010040	S.RES ERJ2GGEJ-JPW	B	49.8/16.5
R504	7030005090	S.RES ERJ2GGEJ 104 X (100K)	T	75.3/17.9
R505	7030005290	S.RES ERJ2GGEJ 682 X (6.8K)	T	76.1/22.7
R506	7030005050	S.RES ERJ2GGEJ 103 X (10K)	T	74.8/21.5
R613	7030005120	S.RES ERJ2GGEJ 102 X (1K)	T	81.2/39.3
R614	7030005030	S.RES ERJ2GGEJ 152 X (1.5K)	B	56.2/24.3
R615	7030005040	S.RES ERJ2GGEJ 472 X (4.7K)	T	50.7/27.7
R616	7030008300	S.RES ERJ2GGEJ 184 X (180K)	B	59.9/19.6
R617	7030005090	S.RES ERJ2GGEJ 104 X (100K)	B	57.4/15.8
R618	7030004980	S.RES ERJ2GGEJ 101 X (100)	B	62.1/16.9
R619	7030005030	S.RES ERJ2GGEJ 152 X (1.5K)	B	36.0/27.5
R620	7030005240	S.RES ERJ2GGEJ 473 X (47K)	B	57.4/18.4
R621	7410001130	S.ARR EXB28V102JX	B	76.6/19.6
R622	7030007570	S.RES ERJ2GGEJ 122 X (1.2K)	B	83.8/21.6
R623	7030005090	S.RES ERJ2GGEJ 104 X (100K)	T	50.7/26.1
R624	7030005090	S.RES ERJ2GGEJ 104 X (100K)	T	83.2/11.6
R625	7030010040	S.RES ERJ2GGEJ-JPW	B	96.1/20.1
R1003	7030007601	S.RES ERA3YKD 913V (91K)	B	72.6/9.4
R1004	7030006101	S.RES ERA3YED 183V (18K)	B	70.2/10.2
R1005	7030005120	S.RES ERJ2GGEJ 102 X (1K)	T	112.3/16.5
R1006	7030005090	S.RES ERJ2GGEJ 104 X (100K)	B	112.4/8.1
R1008	7030010040	S.RES ERJ2GGEJ-JPW	T	124.9/24.8
R1009	7030005050	S.RES ERJ2GGEJ 103 X (10K)	T	133.3/49.2
R1010	7030005050	S.RES ERJ2GGEJ 103 X (10K)	T	128.6/23.8
R1012	7030005040	S.RES ERJ2GGEJ 472 X (4.7K)	T	110.6/46.0
R1013	7030005240	S.RES ERJ2GGEJ 473 X (47K)	T	114.7/49.0
R1014	7030005090	S.RES ERJ2GGEJ 104 X (100K)	T	98.3/12.1
R1015	7030005120	S.RES ERJ2GGEJ 102 X (1K)	B	115.3/22.8
R1016	7030005090	S.RES ERJ2GGEJ 104 X (100K)	B	115.6/6.1
R1018	7030005090	S.RES ERJ2GGEJ 104 X (100K)	T	111.7/7.0
R1020	7030005090	S.RES ERJ2GGEJ 104 X (100K)	B	114.7/24.9
R1021	7030005120	S.RES ERJ2GGEJ 102 X (1K)	B	116.5/6.1
R1022	7030005120	S.RES ERJ2GGEJ 102 X (1K)	T	114.9/7.1
R1023	7030005050	S.RES ERJ2GGEJ 103 X (10K)	B	125.2/15.7
R1024	7030007290	S.RES ERJ2GGEJ 222 X (2.2K)	B	131.6/17.6
R1025	7030000480	S.RES MCR10EZHJ 6.8K (682)	B	129.4/47.0
R1026	7030000480	S.RES MCR10EZHJ 6.8K (682)	B	129.4/48.8
R1027	7030010040	S.RES ERJ2GGEJ-JPW	T	113.7/16.5
R1028	7030004970	S.RES ERJ2GGEJ 470 X (47)	B	114.9/13.4
R1029	7030005120	S.RES ERJ2GGEJ 102 X (1K)	T	115.3/10.5
R1030	7030005050	S.RES ERJ2GGEJ 103 X (10K)	T	114.4/10.3
R1031	7030005050	S.RES ERJ2GGEJ 103 X (10K)	B	117.8/7.7
R1032	7030005050	S.RES ERJ2GGEJ 103 X (10K)	B	127.1/19.9
R1033	7030000480	S.RES MCR10EZHJ 6.8K (682)	B	129.4/45.2
R1034	7030005040	S.RES ERJ2GGEJ 472 X (4.7K)	B	123.6/17.5
R1035	7030005050	S.RES ERJ2GGEJ 103 X (10K)	T	107.8/42.5
R1036	7030005040	S.RES ERJ2GGEJ 472 X (4.7K)	T	107.8/41.2
R1037	7030005090	S.RES ERJ2GGEJ 104 X (100K)	T	95.9/13.5
R1038	7030005120	S.RES ERJ2GGEJ 102 X (1K)	B	125.6/36.3
R1039	7030005090	S.RES ERJ2GGEJ 104 X (100K)	B	113.7/12.9
R1040	7030005160	S.RES ERJ2GGEJ 105 X (1M)	T	111.2/12.9
R1043	7030005160	S.RES ERJ2GGEJ 105 X (1M)	B	112.0/11.0
R1044	7030005090	S.RES ERJ2GGEJ 104 X (100K)	B	117.9/9.9
R1045	7030005050	S.RES ERJ2GGEJ 103 X (10K)	B	120.4/17.1
R1046	7030005800	S.RES RR0510P-102-D (1K)	B	119.7/9.0
R1047	7030005050	S.RES ERJ2GGEJ 103 X (10K)	B	119.4/18.6
R1048	7030009710	S.RES ERJ2GGEJ 203 X (20K)	B	119.0/22.4
R1049	7030005040	S.RES ERJ2GGEJ 472 X (4.7K)	B	116.7/19.7
R1050	7030007290	S.RES ERJ2GGEJ 222 X (2.2K)	B	123.0/38.1
R1054	7030008270	S.RES RR0510P-104-D (100K)	B	119.7/9.9
R1055	7030005090	S.RES ERJ2GGEJ 104 X (100K)	B	120.4/15.2
R1056	7030008270	S.RES RR0510P-104-D (100K)	B	118.8/10.8
R1057	7030005100	S.RES ERJ2GGEJ 154 X (150K)	B	118.8/15.2
R1059	7410001130	S.ARR EXB28V102JX	T	69.7/14.8
R1060	7410001130	S.ARR EXB28V102JX	T	63.4/14.8
R1062	7030008270	S.RES RR0510P-104-D (100K)	B	116.0/14.8
R1063	7030007340	S.RES ERJ2GGEJ 153 X (15K)	B	42.8/22.4
R1064	7030005090	S.RES ERJ2GGEJ 104 X (100K)	T	40.5/23.1
R1068	7030005120	S.RES ERJ2GGEJ 102 X (1K)	T	74.3/14.1
R1069	7030005120	S.RES ERJ2GGEJ 102 X (1K)	T	72.6/14.1
R1070	7030005120	S.RES ERJ2GGEJ 102 X (1K)	T	57.3/15.1
R1071	7030005090	S.RES ERJ2GGEJ 104 X (100K)	T	51.7/16.7
R1072	7030005040	S.RES ERJ2GGEJ 472 X (4.7K)	T	52.9/16.3
R1073	7030005700	S.RES ERJ2GGEJ 274 X (270K)	B	50.8/18.7
R1074	7030005100	S.RES ERJ2GGEJ 154 X (150K)	T	32.7/20.6
R1075	7030008010	S.RES ERJ2GGEJ 123 X (12K)	T	36.3/21.5
R1076	7030005090	S.RES ERJ2GGEJ 104 X (100K)	B	35.0/20.4
R1077	7030005170	S.RES ERJ2GGEJ 474 X (470K)	B	36.6/20.2
R1078	7030005090	S.RES ERJ2GGEJ 104 X (100K)	B	32.2/15.2
R1080	7030005310	S.RES ERJ2GGEJ 124 X (120K)	B	40.1/13.5
R1081	7030008290	S.RES ERJ2GGEJ 183 X (18K)	T	42.5/19.5
R1082	7410001130	S.ARR EXB28V102JX	T	56.9/6.7
R1083	7030005120	S.RES ERJ2GGEJ 102 X (1K)	B	69.1/8.8
R1084	7410001130	S.ARR EXB28V102JX	T	61.7/6.1
R1085	7030005120	S.RES ERJ2GGEJ 102 X (1K)	B	49.5/9.9
R1086	7030005100	S.RES ERJ2GGEJ 154 X (150K)	B	32.2/18.5
R1087	7030007340	S.RES ERJ2GGEJ 153 X (15K)	B	31.3/15.2
R1088	7030005160	S.RES ERJ2GGEJ 105 X (1M)	B	31.3/16.9
R1089	7030005050	S.RES ERJ2GGEJ 103 X (10K)	B	44.2/16.9
R1090	7030008300	S.RES ERJ2GGEJ 184 X (180K)	B	36.5/13.4
R1092	7030008400	S.RES ERJ2GGEJ 182 X (1.8K)	B	38.3/13.5
R1093	7030005090	S.RES ERJ2GGEJ 104 X (100K)	B	42.9/15.5
R1094	7030005090	S.RES ERJ2GGEJ 104 X (100K)	T	55.7/12.8
R1095	7030009290	S.RES ERJ2GGEJ 562 X (5.6K)	T	55.7/13.7
R1096	7030005100	S.RES ERJ2GGEJ 154 X (150K)	B	35.6/13.4
R1097	7030007290	S.RES ERJ2GGEJ 222 X (2.2K)	T	55.2/11.6
R1098	7510001730	S.THE ERTJOEP 473J	T	74.9/15.5
R1099	7030008270	S.RES RR0510P-104-D (100K)	T	72.5/15.5
R1100	7410001130	S.ARR EXB28V102JX	T	75.3/6.0
R1101	7030005290	S.RES ERJ2GGEJ 682 X (6.8K)	B	44.0/20.4
R1102	7030005040	S.RES ERJ2GGEJ 472 X (4.7K)	B	42.4/16.4
R1103	7030005290	S.RES ERJ2GGEJ 682 X (6.8K)	B	52.9/18.3
R1105	7030003860	S.RES ERJ3GEJ JPW V [EXP-02]	T	127.8/48.9
	7030003220	S.RES ERJ3GEYJ 150 V (15) [USA-02]		
	7030003220	S.RES ERJ3GEYJ 150 V (15) [EXP-04]		

[MAIN-B UNIT] (For [High band] versions)

REF NO.	PARTS NO.	DESCRIPTION	M.	H/V LOCATION
R1106	7030009290	S.RES ERJ2GGEJ 562 X (5.6K)	B	41.0/20.8
R1107	7030008410	S.RES ERJ2GGEJ 392 X (3.9K)	B	39.2/20.8
R1108	7030005240	S.RES ERJ2GGEJ 473 X (47K)	B	124.9/41.7
R1111	7030005060	S.RES ERJ2GGEJ 333 X (33K)	T	36.3/19.7
R1112	7030005230	S.RES ERJ2GGEJ 334 X (330K)	B	41.5/19.6
R1113	7030005720	S.RES ERJ2GGEJ 563 X (56K)	T	44.0/21.3
R1114	7030005120	S.RES ERJ2GGEJ 102 X (1K)	B	65.8/6.4
R1115	7030005120	S.RES ERJ2GGEJ 102 X (1K)	T	65.8/5.4
R1116	7030007300	S.RES ERJ2GGEJ 332 X (3.3K)	T	73.7/15.0
R1117	7030005090	S.RES ERJ2GGEJ 104 X (100K)	B	42.4/18.2
R2003	7030007250	S.RES ERJ2GGEJ 220 X (22)	B	16.7/6.8
R2004	7030005210	S.RES ERJ2GGEJ 822 X (8.2K)	B	12.6/8.8
R2005	7030005210	S.RES ERJ2GGEJ 822 X (8.2K)	B	15.8/6.8
R2009	7030007290	S.RES ERJ2GGEJ 222 X (2.2K)	B	10.5/11.7
R2010	7030004980	S.RES ERJ2GGEJ 101 X (100)	T	11.5/11.7
R2011	7030004980	S.RES ERJ2GGEJ 101 X (100)	T	23.0/10.4
R2012	7030004980	S.RES ERJ2GGEJ 101 X (100)	T	22.5/11.3
R2013	7030005240	S.RES ERJ2GGEJ 473 X (47K)	B	19.8/12.0
R2015	7030005240	S.RES ERJ2GGEJ 473 X (47K)	T	18.4/11.6
R2016	7030010040	S.RES ERJ2GGEJ-JPW	B	24.0/5.8
R2019	7030010040	S.RES ERJ2GGEJ-JPW	B	9.9/17.9
R2020	7030010040	S.RES ERJ2GGEJ-JPW	B	14.4/11.1
R2021	7030004980	S.RES ERJ2GGEJ 101 X (100)	B	23.6/12.1
R2022	7030004980	S.RES ERJ2GGEJ 101 X (100)	B	27.9/24.7
R2024	7030005240	S.RES ERJ2GGEJ 473 X (47K)	B	26.6/21.6
R2026	7030004970	S.RES ERJ2GGEJ 470 X (47)	B	27.9/22.9
R2028	7030005240	S.RES ERJ2GGEJ 473 X (47K)	B	12.1/19.3
R2030	7030005240	S.RES ERJ2GGEJ 473 X (47K)	B	11.0/21.2
R2031	7030005240	S.RES ERJ2GGEJ 473 X (47K)	B	10.7/29.4
R2032	7030005240	S.RES ERJ2GGEJ 473 X (47K)	B	24.9/17.4
R2034	7030005240	S.RES ERJ2GGEJ 473 X (47K)	B	28.8/10.5
R2035	7030005240	S.RES ERJ2GGEJ 473 X (47K)	B	26.7/14.9
R2036	7030004980	S.RES ERJ2GGEJ 101 X (100)	T	26.8/11.9
R2037	7030007290	S.RES ERJ2GGEJ 222 X (2.2K)	T	28.1/10.7
R2038	7030004970	S.RES ERJ2GGEJ 470 X (47)	B	28.8/12.1
R2039	7030005240	S.RES ERJ2GGEJ 473 X (47K)	B	24.1/9.5
R2040	7030005240	S.RES ERJ2GGEJ 473 X (47K)	B	24.5/12.1
R2043	7410001140	S.ARR EXB28V104JX	T	15.6/26.7
R2044	7410001140	S.ARR EXB28V104JX	B	20.8/26.3
R2045	7410001140	S.ARR EXB28V104JX	T	27.0/22.6
R2046	7410001140	S.ARR EXB28V104JX	T	19.3/26.7
R2047	7410001140	S.ARR EXB28V104JX	B	10.9/14.5
R2048	7030005090	S.RES ERJ2GGEJ 104 X (100K)	T	25.7/14.4
R2049	7030005090	S.RES ERJ2GGEJ 104 X (100K)	B	21.8/15.6
R2050	7410001140	S.ARR EXB28V104JX	B	22.6/18.2
R2051	7410001140	S.ARR EXB28V104JX	T	9.9/17.6
R2052	7030005090	S.RES ERJ2GGEJ 104 X (100K)	T	16.8/11.7
R2053	7030005090	S.RES ERJ2GGEJ 104 X (100K)	B	16.0/14.5
R2056	7030010040	S.RES ERJ2GGEJ-JPW	T	10.6/20.0
R2057	7030005090	S.RES ERJ2GGEJ 104 X (100K)	T	10.4/22.9
R2058	7410001140	S.ARR EXB28V104JX	B	17.0/18.6
R2059	7030005090	S.RES ERJ2GGEJ 104 X (100K)	T	10.4/23.8
R2060	7030005090	S.RES ERJ2GGEJ 104 X (100K)	T	25.7/15.6
R2061	7030005090	S.RES ERJ2GGEJ 104 X (100K)	B	14.7/12.6
R2062	7030005090	S.RES ERJ2GGEJ 104 X (100K)	B	17.7/14.4
R2063	7030005090	S.RES ERJ2GGEJ 104 X (100K)	B	22.1/23.4
R2064	7030005090	S.RES ERJ2GGEJ 104 X (100K)	B	19.7/17.7
R2065	7030005030	S.RES ERJ2GGEJ 152 X (1.5K)	B	13.8/6.8
R2066	7410001170	S.ARR EXB28V470JX	T	21.3/6.7
R2067	7030010040	S.RES ERJ2GGEJ-JPW	T	11.4/5.3
R2068	7030010040	S.RES ERJ2GGEJ-JPW	T	20.9/10.4
R2071	7030010040	S.RES ERJ2GGEJ-JPW	T	24.9/5.7
R2072	7030005050	S.RES ERJ2GGEJ 103 X (10K)	B	12.2/10.1
R2074	7030010040	S.RES ERJ2GGEJ-JPW	T	8.7/10.0
R2084	7030010040	S.RES ERJ2GGEJ-JPW	T	30.7/10.5
R2085	7030010040	S.RES ERJ2GGEJ-JPW	B	19.5/9.6
C1	4030011050	S.CER GRM31M3C2H3R0CY21L (GRM42-6 CJ)	B	8.4/66.6
C2	4030011070	S.CER GRM31M2C2H5R0CY21L (GRM42-6 CH)	B	7.4/58.6
C3	4030009500	S.CER C1608 CH 1H 0R5B-T	B	25.6/51.9
C4	4030009500	S.CER C1608 CH 1H 0R5B-T	B	16.4/51.9
C5	4030009500	S.CER C1608 CH 1H 0R5B-T	B	8.2/54.5
C6	4030011060	S.CER GRM31M2C2H4R0CY21L (GRM42-6 CH)	B	7.4

[MAIN-B UNIT] (For [High band] versions)

REF NO.	PARTS NO.	DESCRIPTION	M.	H/V LOCATION
C30	4030017390	S.CER C1005 CH 1H 180J-T	[EXP-02]	B 39.2/37.7
	4030017630	S.CER C1005 CH 1H 120J-T	[USA-02]	
	4030017630	S.CER C1005 CH 1H 120J-T	[EXP-04]	
C31	4030016930	S.CER C1005 JB 1A 104K-T	B	51.5/37.4
C32	4030017460	S.CER C1005 JB 1H 102K-T	B	41.3/40.7
C33	4030017420	S.CER C1005 CH 1H 470J-T	B	38.6/40.7
C34	4030017460	S.CER C1005 JB 1H 102K-T	B	37.7/40.7
C36	4030017460	S.CER C1005 JB 1H 102K-T	B	51.5/41.2
C37	4030017730	S.CER C1005 JB 1H 471K-T	B	49.0/42.7
C38	4030017460	S.CER C1005 JB 1H 102K-T	B	39.2/35.9
C39	4030017610	S.CER C1005 CH 1H 090C-T	B	52.8/40.2
C40	4030017540	S.CER C1005 CH 1H R75B-T	B	54.1/39.2
C41	4030017400	S.CER C1005 CH 1H 220J-T	B	66.9/39.2
C42	4030017460	S.CER C1005 JB 1H 102K-T	T	54.0/37.8
C43	4030016930	S.CER C1005 JB 1A 104K-T	B	54.1/38.3
C44	4030017560	S.CER C1005 CH 1H 2R5B-T	B	59.9/40.5
C45	4030017620	S.CER C1005 CH 1H 100C-T	B	55.5/42.0
C48	4030017420	S.CER C1005 CH 1H 470J-T	B	72.2/40.6
C49	4030017380	S.CER C1005 CH 1H 050B-T	B	75.9/39.2
C50	4030017460	S.CER C1005 JB 1H 102K-T	B	73.1/40.6
C51	4030017460	S.CER C1005 JB 1H 102K-T	T	72.4/41.1
C52	4030017620	S.CER C1005 CH 1H 100C-T	B	70.4/41.2
C53	4030016790	S.CER C1005 JB 1E 103K-T	B	71.3/42.8
C54	4030017730	S.CER C1005 JB 1H 471K-T	B	70.4/42.8
C57	4030017460	S.CER C1005 JB 1H 102K-T	B	74.6/36.7
C58	4030017460	S.CER C1005 JB 1H 102K-T	T	67.2/26.1
C59	4030017460	S.CER C1005 JB 1H 102K-T	T	66.9/22.7
C60	4030016790	S.CER C1005 JB 1E 103K-T	T	65.3/26.6
C61	4030017430	S.CER C1005 CH 1H 101J-T	T	61.6/23.1
C62	4030017420	S.CER C1005 CH 1H 470J-T	B	57.1/24.3
C63	4030017420	S.CER C1005 CH 1H 470J-T	B	60.3/14.3
C64	4030016790	S.CER C1005 JB 1E 103K-T	B	56.2/26.8
C65	4030018860	S.CER C1005 JB 0J 105K-T	T	58.2/19.6
C66	4030017460	S.CER C1005 JB 1H 102K-T	T	54.7/19.9
C67	4030017460	S.CER C1005 JB 1H 102K-T	B	58.4/21.3
C68	4030017680	S.CER C1005 CH 1H 820J-T	T	52.2/23.8
C69	4030017710	S.CER C1005 CH 1H 181J-T	T	54.0/23.8
C70	4030017710	S.CER C1005 CH 1H 181J-T	T	54.0/25.6
C71	4030016930	S.CER C1005 JB 1A 104K-T	T	57.4/29.0
C72	4030017730	S.CER C1005 JB 1H 471K-T	[USA-02]	T 59.8/48.0
	4030017730	S.CER C1005 JB 1H 471K-T	[EXP-04]	
C74	4030017730	S.CER C1005 JB 1H 471K-T	B	11.2/50.5
C75	4030019560	S.CER GRM21BB31C106KE15L	T	61.6/25.3
C76	4030016790	S.CER C1005 JB 1E 103K-T	T	57.8/54.9
C77	4030017460	S.CER C1005 JB 1H 102K-T	T	56.8/50.7
C78	4030017730	S.CER C1005 JB 1H 471K-T	B	58.8/56.6
C79	4030016960	S.CER C1005 JB 1E 183K-T	T	62.4/55.0
C81	4030017460	S.CER C1005 JB 1H 102K-T	T	65.1/55.0
C82	4030011050	S.CER GRM31M3C2H3R0CY21L (GRM42-6 CJ)	T	34.9/65.2
C84	4030017420	S.CER C1005 CH 1H 470J-T	T	55.0/61.6
C85	4030017460	S.CER C1005 JB 1H 102K-T	T	56.0/61.6
C86	4030017710	S.CER C1005 CH 1H 181J-T	T	81.3/63.8
C87	4030017460	S.CER C1005 JB 1H 102K-T	T	79.8/68.8
C88	4030017730	S.CER C1005 JB 1H 471K-T	T	64.6/52.1
C89	4030017590	S.CER C1005 CH 1H 070C-T	B	87.3/57.5
C90	4030017590	S.CER C1005 CH 1H 070C-T	B	88.2/57.5
C92	4030017570	S.CER C1005 CH 1H 040B-T	B	89.9/58.0
C93	4030017590	S.CER C1005 CH 1H 070C-T	B	86.9/51.5
C96	4030017460	S.CER C1005 JB 1H 102K-T	B	87.8/56.3
C97	4030017730	S.CER C1005 JB 1H 471K-T	B	87.8/55.4
C98	4030017390	S.CER C1005 CH 1H 180J-T	B	83.5/48.7
C99	4030017730	S.CER C1005 JB 1H 471K-T	B	81.4/48.3
C100	4030017590	S.CER C1005 CH 1H 070C-T	B	91.2/34.9
C102	4030017590	S.CER C1005 CH 1H 070C-T	B	97.1/33.8
C103	4030017360	S.CER C1005 CH 1H 030B-T	B	98.5/32.2
C104	4030017460	S.CER C1005 JB 1H 102K-T	B	100.8/29.9
C105	4030017730	S.CER C1005 JB 1H 471K-T	B	97.6/28.9
C106	4030017420	S.CER C1005 CH 1H 470J-T	B	91.7/48.9
C107	4030017460	S.CER C1005 JB 1H 102K-T	T	80.2/51.7
C108	4030016790	S.CER C1005 JB 1E 103K-T	B	81.3/49.2
C109	4030017460	S.CER C1005 JB 1H 102K-T	B	95.8/35.3
C110	4030017730	S.CER C1005 JB 1H 471K-T	B	98.6/35.3
C111	4030017730	S.CER C1005 JB 1H 471K-T	T	101.7/37.1
C112	4030016930	S.CER C1005 JB 1A 104K-T	T	100.8/37.1
C113	4030017540	S.CER C1005 CH 1H R75B-T	[EXP-02]	B 102.0/29.6
	4030017520	S.CER C1005 CH 1H 0R3B-T	[USA-02]	
	4030017520	S.CER C1005 CH 1H 0R3B-T	[EXP-04]	
C114	4030017600	S.CER C1005 CH 1H 080C-T	B	98.3/26.1
C115	4030017620	S.CER C1005 CH 1H 100C-T	B	98.8/21.9
C116	4030017460	S.CER C1005 JB 1H 102K-T	B	107.5/30.0
C117	4030017730	S.CER C1005 JB 1H 471K-T	B	107.5/30.9
C118	4030017520	S.CER C1005 CH 1H 0R3B-T	B	102.8/32.0
C119	4030016790	S.CER C1005 JB 1E 103K-T	B	97.0/21.9
C120	4030017730	S.CER C1005 JB 1H 471K-T	B	97.9/21.9
C121	4030017590	S.CER C1005 CH 1H 070C-T	B	103.3/30.8
C122	4030017620	S.CER C1005 CH 1H 100C-T	B	107.5/31.8
C123	4030017600	S.CER C1005 CH 1H 080C-T	B	104.8/28.2
C124	4030017640	S.CER C1005 CH 1H 150J-T	B	105.0/20.8
C125	4030017420	S.CER C1005 CH 1H 470J-T	B	101.7/27.5
C126	4030017380	S.CER C1005 CH 1H 050B-T	B	95.6/23.7
C127	4030017640	S.CER C1005 CH 1H 150J-T	B	96.1/21.9
C128	4030017360	S.CER C1005 CH 1H 030B-T	B	99.2/27.3
C129	4030017520	S.CER C1005 CH 1H 0R3B-T	B	103.5/27.5
C131	4030017540	S.CER C1005 CH 1H R75B-T	B	106.4/27.2
C132	4030017460	S.CER C1005 JB 1H 102K-T	T	94.3/12.6
C133	4030017610	S.CER C1005 CH 1H 090C-T	B	105.4/22.7
C134	4030017600	S.CER C1005 CH 1H 080C-T	B	93.7/22.8
C135	4030016790	S.CER C1005 JB 1E 103K-T	T	78.3/21.0
C139	4030016930	S.CER C1005 JB 1A 104K-T	B	107.5/33.6
C140	4030017430	S.CER C1005 CH 1H 101J-T	B	81.2/18.9
C141	4030017460	S.CER C1005 JB 1H 102K-T	T	75.7/21.5
C143	4030017460	S.CER C1005 JB 1H 102K-T	T	78.9/22.2
C144	4030017420	S.CER C1005 CH 1H 470J-T	T	92.5/16.1
C146	4550000520	S.TAN TEESVA 1V 683M8R	T	84.7/22.9

[MAIN-B UNIT] (For [High band] versions)

REF NO.	PARTS NO.	DESCRIPTION	M.	H/V LOCATION
C147	4550003250	S.TAN TEESVA 1V 474M8R	T	80.5/22.9
C148	4030019560	S.CER GRM21BB31C106KE15L	T	109.7/30.5
C151	4030016930	S.CER C1005 JB 1A 104K-T	B	75.3/18.1
C152	4030017420	S.CER C1005 CH 1H 470J-T	B	77.8/18.1
C153	4030017420	S.CER C1005 CH 1H 470J-T	B	78.1/16.2
C154	4030017420	S.CER C1005 CH 1H 470J-T	B	76.4/16.2
C155	4030017460	S.CER C1005 JB 1H 102K-T	B	81.7/16.7
C156	4030016790	S.CER C1005 JB 1E 103K-T	B	81.2/17.9
C157	4030017620	S.CER C1005 CH 1H 100C-T	B	72.4/24.4
C160	4030016930	S.CER C1005 JB 1A 104K-T	B	74.2/21.3
C162	4030016790	S.CER C1005 JB 1E 103K-T	B	72.4/17.7
C165	4030017460	S.CER C1005 JB 1H 102K-T	B	74.1/23.5
C192	4030017350	S.CER C1005 CH 1H 020B-T	B	34.3/40.5
C193	4030017530	S.CER C1005 CH 1H 0R5B-T	B	51.5/38.3
C277	4030016930	S.CER C1005 JB 1A 104K-T	B	36.0/28.4
C281	4030017770	S.CER C1005 JB 1H 332K-T	T	92.0/13.5
C282	4030016930	S.CER C1005 JB 1A 104K-T	T	44.2/28.0
C283	4030016930	S.CER C1005 JB 1A 104K-T	T	42.5/25.2
C284	4030016930	S.CER C1005 JB 1A 104K-T	T	44.2/28.9
C285	4030017570	S.CER C1005 CH 1H 040B-T	B	94.0/29.9
C286	4030017600	S.CER C1005 CH 1H 080C-T	B	36.4/26.3
C287	4030017460	S.CER C1005 JB 1H 102K-T	T	95.9/11.7
C298	4030017370	S.CER C1005 CH 1H 3R5B-T	T	86.3/29.4
C299	4030017370	S.CER C1005 CH 1H 3R5B-T	T	83.9/29.4
C300	4030017350	S.CER C1005 CH 1H 020B-T	T	85.1/30.8
C301	4030017730	S.CER C1005 JB 1H 471K-T	B	92.8/31.3
C302	4030017420	S.CER C1005 CH 1H 470J-T	B	80.1/39.2
C303	4030017730	S.CER C1005 JB 1H 471K-T	B	80.1/36.3
C305	4030017500	S.CER C1005 CH 1H 560J-T	B	64.8/24.2
C306	4030017580	S.CER C1005 CH 1H 060C-T	B	64.3/25.4
C307	4030017500	S.CER C1005 CH 1H 560J-T	B	61.3/22.7
C308	4030017360	S.CER C1005 CH 1H 030B-T	B	60.1/23.2
C309	4030016790	S.CER C1005 JB 1E 103K-T	B	67.4/21.8
C312	4030016930	S.CER C1005 JB 1A 104K-T	B	67.4/20.9
C314	4030016790	S.CER C1005 JB 1E 103K-T	T	110.5/33.8
C323	4030017620	S.CER C1005 CH 1H 100C-T	B	72.3/26.2
C332	4030017530	S.CER C1005 CH 1H 0R5B-T	B	84.9/50.0
C333	4030017420	S.CER C1005 CH 1H 470J-T	B	40.4/40.7
C334	4030017590	S.CER C1005 CH 1H 070C-T	B	94.9/68.3
C335	4030017630	S.CER C1005 CH 1H 120J-T	B	93.8/68.3
C336	4030017710	S.CER C1005 CH 1H 181J-T	B	62.0/68.7
C337	4030017460	S.CER C1005 JB 1H 102K-T	T	82.7/29.2
C340	4030017710	S.CER C1005 CH 1H 181J-T	B	107.7/28.7
C342	4550002980	S.TAN TEESVA 1C 225M8R	T	78.4/66.1
C343	4030017460	S.CER C1005 JB 1H 102K-T	B	51.5/39.2
C344	4030017460	S.CER C1005 JB 1H 102K-T	B	54.2/68.0
C345	4030017730	S.CER C1005 JB 1H 471K-T	B	54.2/67.1
C346	4030017420	S.CER C1005 CH 1H 470J-T	B	66.0/68.7
C347	4030017460	S.CER C1005 JB 1H 102K-T	T	52.2/22.9
C348	4030017460	S.CER C1005 JB 1H 102K-T	T	59.3/20.5
C350	4030017920	S.CER C1005 JB 1A 683K-T	T	95.9/14.4
C357	4030016930	S.CER C1005 JB 1A 104K-T	T	103.5/34.7
C358	4030017340	S.CER C1005 CH 1H 010B-T	B	91.2/35.8
C366	4030017460	S.CER C1005 JB 1H 102K-T	B	97.0/64.4
C367	4030017730	S.CER C1005 JB 1H 471K-T	B	97.0/65.8
C368	4030017420	S.CER C1005 CH 1H 470J-T		

[MAIN-B UNIT] (For [High band] versions)

REF NO.	PARTS NO.	DESCRIPTION	M.	H/V LOCATION
C624	4030017460	S.CER C1005 JB 1H 102K-T	B	81.2/26.7
C625	4030019990	S.CER C1005 JB 1C 104K-T	B	63.3/16.4
C626	4030017430	S.CER C1005 CH 1H 101J-T	B	59.9/20.5
C627	4030018910	S.CER C1608 JB 0J 475K-T	B	57.7/19.6
C628	4030017590	S.CER C1005 CH 1H 070C-T	T	63.3/36.2
C629	4030017530	S.CER C1005 CH 1H 0R5B-T	T	66.8/29.7
C630	4030016790	S.CER C1005 JB 1E 103K-T	T	66.8/28.8
C631	4030016790	S.CER C1005 JB 1E 103K-T	T	68.6/41.6
C632	4030016790	S.CER C1005 JB 1E 103K-T	T	76.5/41.6
C633	4030016930	S.CER C1005 JB 1A 104K-T	T	81.3/43.1
C634	4030016930	S.CER C1005 JB 1A 104K-T	T	80.0/41.2
C635	4030016790	S.CER C1005 JB 1E 103K-T	T	71.5/29.7
C637	4030017600	S.CER C1005 CH 1H 080C-T	T	72.3/36.2
C638	4030017460	S.CER C1005 CH 1H 102K-T	T	83.5/42.2
C639	4030016930	S.CER C1005 JB 1A 104K-T	T	46.8/25.7
C640	4030017040	S.CER C1005 JB 1A 333K-T	B	38.8/24.4
C641	4030018890	S.CER C1005 JB 0J 224K-T	B	76.3/27.1
C642	4030018890	S.CER C1005 JB 0J 224K-T	B	77.5/27.0
C643	4030017430	S.CER C1005 CH 1H 101J-T	B	75.7/27.9
C644	4030019560	S.CER GRM21BB31C106KE15L	B	81.7/20.4
C645	4030016930	S.CER C1005 JB 1A 104K-T	B	30.0/15.7
C646	4030017460	S.CER C1005 JB 1H 102K-T	T	84.7/10.0
C647	4030016790	S.CER C1005 JB 1E 103K-T	B	59.1/27.7
C1003	4030017460	S.CER C1005 JB 1H 102K-T	T	133.3/63.5
C1005	4030018980	S.CER C1608 JB 1H 104K-T	B	100.1/11.8
C1007	4030017460	S.CER C1005 JB 1H 102K-T	T	100.1/12.1
C1008	4510009680	S.ELE EEEFK1E471P	B	110.2/52.6
C1010	4030017460	S.CER C1005 JB 1H 102K-T	B	106.5/59.0
C1011	4030016930	S.CER C1005 JB 1A 104K-T	B	93.9/12.1
C1012	4030017420	S.CER C1005 CH 1H 470J-T	B	117.5/16.6
C1014	4030017460	S.CER C1005 JB 1H 102K-T	T	116.6/27.5
C1015	4030017460	S.CER C1005 JB 1H 102K-T	T	114.9/8.0
C1017	4030017460	S.CER C1005 JB 1H 102K-T	B	122.5/64.9
C1018	4030017460	S.CER C1005 JB 1H 102K-T	T	133.3/45.0
C1019	4510009250	S.ELE EEEFK1C471P	B	130.5/34.8
C1022	4030017420	S.CER C1005 CH 1H 470J-T	B	105.5/59.0
C1023	4030017460	S.CER C1005 JB 1H 102K-T	B	113.4/58.8
C1024	4030017440	S.CER C1005 CH 1H 221J-T	B	113.4/59.7
C1025	4030017510	S.CER C1005 CH 1H 680J-T	B	113.4/60.6
C1026	4030019120	S.CER GRM188B31E105KA75D	T	115.8/49.5
C1028	4030017460	S.CER C1005 JB 1H 102K-T	B	117.4/6.1
C1029	4030017460	S.CER C1005 JB 1H 102K-T	T	114.9/12.6
C1031	4030017460	S.CER C1005 JB 1H 102K-T	T	115.0/16.9
C1032	4030016930	S.CER C1005 JB 1A 104K-T	B	123.6/16.6
C1033	4510009680	S.ELE EEEFK1E471P	B	120.0/29.1
C1034	4030018860	S.CER C1005 JB 0J 105K-T	B	131.6/16.6
C1035	4030016790	S.CER C1005 JB 1E 103K-T	B	131.6/18.7
C1036	4030018980	S.CER C1608 JB 1H 104K-T	T	128.4/46.9
C1037	4030019560	S.CER GRM21BB31C106KE15L	B	129.4/43.4
C1038	4030011600	S.CER C1608 JB 1E 104K-T	T	110.5/48.7
C1039	4510009680	S.ELE EEEFK1E471P	B	117.0/41.7
C1040	4030019560	S.CER GRM21BB31C106KE15L	B	116.7/22.2
C1042	4030016930	S.CER C1005 JB 1A 104K-T	B	118.1/22.4
C1043	4030016930	S.CER C1005 JB 1A 104K-T	T	114.9/16.0
C1045	4030017460	S.CER C1005 JB 1H 102K-T	T	114.9/14.2
C1046	4030018860	S.CER C1005 JB 0J 105K-T	T	114.9/15.1
C1048	4030018900	S.CER C1005 JB 0J 474K-T	B	126.7/18.6
C1050	4030018860	S.CER C1005 JB 0J 105K-T	B	125.2/16.6
C1051	4030017460	S.CER C1005 JB 1H 102K-T	B	122.1/48.2
C1052	4030016930	S.CER C1005 JB 1A 104K-T	T	127.8/40.1
C1053	4030019560	S.CER GRM21BB31C106KE15L	T	127.8/44.5
C1056	4030018860	S.CER C1005 JB 0J 105K-T	T	111.2/11.7
C1057	4030016930	S.CER C1005 JB 1A 104K-T	B	118.7/17.1
C1058	4030019560	S.CER GRM21BB31C106KE15L	T	105.5/44.4
C1059	4030017460	S.CER C1005 JB 1H 102K-T	T	107.7/46.3
C1060	4030017460	S.CER C1005 JB 1H 102K-T	B	126.2/39.8
C1061	4030017460	S.CER C1005 JB 1H 102K-T	T	107.7/37.4
C1062	4030017460	S.CER C1005 JB 1H 102K-T	B	120.7/22.9
C1063	4030019560	S.CER GRM21BB31C106KE15L	B	126.9/22.2
C1064	4030019560	S.CER GRM21BB31C106KE15L	B	121.6/36.0
C1065	4030017460	S.CER C1005 JB 1H 102K-T	B	120.2/35.6
C1066	4030018860	S.CER C1005 JB 0J 105K-T	B	125.6/38.1
C1070	4030017440	S.CER C1005 CH 1H 221J-T	B	120.4/16.2
C1071	4030016930	S.CER C1005 JB 1A 104K-T	B	120.4/10.8
C1074	4030017460	S.CER C1005 JB 1H 102K-T	B	73.9/10.4
C1075	4030017460	S.CER C1005 JB 1H 102K-T	B	70.7/14.4
C1076	4030017460	S.CER C1005 JB 1H 102K-T	B	69.7/14.4
C1077	4030017460	S.CER C1005 JB 1H 102K-T	B	68.8/14.4
C1080	4030016790	S.CER C1005 JB 1E 103K-T	B	51.1/15.3
C1081	4030016930	S.CER C1005 JB 1A 104K-T	B	117.2/15.2
C1082	4030016930	S.CER C1005 JB 1A 104K-T	B	114.8/14.6
C1083	4030017460	S.CER C1005 JB 1H 102K-T	T	37.6/19.3
C1084	4030017710	S.CER C1005 CH 1H 181J-T	B	41.9/20.8
C1092	4030016930	S.CER C1005 JB 1A 104K-T	B	75.8/14.4
C1095	4030016930	S.CER C1005 JB 1A 104K-T	T	38.5/19.3
C1096	4030018860	S.CER C1005 JB 0J 105K-T	T	51.7/18.5
C1097	4030018240	S.CER C1005 JB 1H 562K-T	B	50.8/17.8
C1098	4030018860	S.CER C1005 JB 0J 105K-T	T	54.5/16.3
C1099	4030018860	S.CER C1005 JB 0J 105K-T	B	45.2/20.8
C1100	4030017460	S.CER C1005 JB 1H 102K-T	B	75.8/9.1
C1101	4030016930	S.CER C1005 JB 1A 104K-T	T	78.2/8.0
C1102	4030017420	S.CER C1005 CH 1H 470J-T	B	71.6/6.6
C1106	4030016930	S.CER C1005 JB 1A 104K-T	T	36.3/20.6
C1107	4030017440	S.CER C1005 CH 1H 221J-T	B	33.1/15.2
C1108	4030017450	S.CER C1005 JB 1H 271K-T	B	39.2/13.5
C1109	4030018860	S.CER C1005 JB 0J 105K-T	T	42.5/18.0
C1110	4030018860	S.CER C1005 JB 0J 105K-T	T	42.5/20.4
C1111	4030018860	S.CER C1005 JB 0J 105K-T	B	46.6/19.1
C1112	4030016930	S.CER C1005 JB 1A 104K-T	B	45.7/19.1
C1119	4030017420	S.CER C1005 CH 1H 470J-T	B	65.2/6.9
C1127	4030017660	S.CER C1005 CH 1H 330J-T	B	36.6/21.2
C1128	4030016930	S.CER C1005 JB 1A 104K-T	B	31.3/13.6
C1129	4030016930	S.CER C1005 JB 1A 104K-T	B	32.2/16.9
C1130	4030017900	S.CER C1005 JB 1E 123K-T	B	37.4/13.5
C1131	4550006970	S.TAN TEESVA0G476M8R	T	53.5/12.1

[MAIN-B UNIT] (For [High band] versions)

REF NO.	PARTS NO.	DESCRIPTION	M.	H/V LOCATION
C1132	4030017460	S.CER C1005 JB 1H 102K-T	T	51.8/13.0
C1133	4030016790	S.CER C1005 JB 1E 103K-T	T	78.2/5.7
C1135	4030017460	S.CER C1005 JB 1H 102K-T	T	73.9/16.8
C1136	4030016930	S.CER C1005 JB 1A 104K-T	T	71.6/15.5
C1137	4030016970	S.CER C1005 JB 1E 223K-T	T	40.1/20.8
		[EXP-02] [USA-02] [EXP-04]		
C1138	4030017460	S.CER C1005 JB 1H 102K-T	T	37.7/15.7
C1139	4030017920	S.CER C1005 JB 1A 683K-T	T	54.5/17.2
C1140	4030017040	S.CER C1005 JB 1A 333K-T	B	52.0/18.3
C1141	4030016790	S.CER C1005 JB 1E 103K-T	B	42.4/17.3
C1142	4030016930	S.CER C1005 JB 1A 104K-T	B	117.6/11.8
C1143	4030018980	S.CER C1608 JB 1H 104K-T	B	93.8/9.4
C1144	4030016930	S.CER C1005 JB 1A 104K-T	B	41.7/15.1
C1145	4030018090	S.CER C1005 JB 1E 822K-T	B	42.8/20.8
C2001	4050000240	S.FEE NFM18PC104R1C3D	T	39.3/10.9
C2002	4030016930	S.CER C1005 JB 1A 104K-T	B	34.9/5.4
C2004	4550007730	S.TAN TEESVJ 0J 106M8R	B	35.3/7.2
C2007	4030018910	S.CER C1608 JB 0J 475K-T	B	18.4/10.4
C2008	4030016930	S.CER C1005 JB 1A 104K-T	B	16.1/8.9
C2009	4050000240	S.FEE NFM18PC104R1C3D	B	28.0/5.9
C2010	4050000240	S.FEE NFM18PC104R1C3D	B	12.3/5.5
C2011	4030019460	S.CER C1608 JB 0J 106M-T	T	33.0/6.9
C2012	4030016930	S.CER C1005 JB 1A 104K-T	B	26.4/5.8
C2013	4550007730	S.TAN TEESVJ 0J 106M8R	B	25.0/6.2
C2014	4030016930	S.CER C1005 JB 1A 104K-T	T	31.7/6.6
C2015	4030016930	S.CER C1005 JB 1A 104K-T	B	10.1/6.4
C2016	4550007720	S.TAN TEESVJ 0G 476M8R	T	26.7/7.1
C2017	4550007730	S.TAN TEESVJ 0J 106M8R	B	17.2/9.2
C2018	4030016930	S.CER C1005 JB 1A 104K-T	B	9.2/6.4
C2019	4030016790	S.CER C1005 JB 1E 103K-T	B	14.8/19.3
C2021	4030018910	S.CER C1608 JB 0J 475K-T	B	16.0/21.6
C2022	4030018910	S.CER C1608 JB 0J 475K-T	B	13.5/14.5
C2023	4030016790	S.CER C1005 JB 1E 103K-T	B	23.1/14.3
C2024	4030018860	S.CER C1005 JB 0J 105K-T	B	21.2/14.1
C2025	4030017420	S.CER C1005 CH 1H 470J-T	B	20.8/11.1
C2026	4030017460	S.CER C1005 JB 1H 102K-T	B	20.8/10.2
C2027	4030018910	S.CER C1608 JB 0J 475K-T	B	10.9/10.0
C2028	4030018860	S.CER C1005 JB 0J 105K-T	T	11.5/10.2
C2031	4030018860	S.CER C1005 JB 0J 105K-T	T	20.9/11.3
C2032	4030016930	S.CER C1005 JB 1A 104K-T	T	13.1/11.7
C2033	4030018860	S.CER C1005 JB 0J 105K-T	B	15.1/17.7
C2034	4030016930	S.CER C1005 JB 1A 104K-T	T	11.9/7.9
C2035	4030018910	S.CER C1608 JB 0J 475K-T	T	10.2/8.2
C2036	4030018860	S.CER C1005 JB 0J 105K-T	B	21.1/20.9
C2038	4030016790	S.CER C1005 JB 1E 103K-T	B	16.4/25.3
C2039	4030017430	S.CER C1005 CH 1H 101J-T	B	19.7/7.5
C2040	4030016790	S.CER C1005 JB 1E 103K-T	T	26.4/18.1
C2041	4030018910	S.CER C1608 JB 0J 475K-T	T	11.1/14.5
C2042	4030016930	S.CER C1005 JB 1A 104K-T	T	10.1/14.8
C2044	4030016790	S.CER C1005 JB 1E 103K-T	T	26.4/19.9
C2045	4030016930	S.CER C1005 JB 1A 104K-T	B	26.6/23.4
C2046	4030016930	S.CER C1005 JB 1A 104K-T	B	26.6/24.3
C2047	4030016930	S.CER C1005 JB 1A 104K-T	B	26.6/20.7
C2048	4030016930	S.CER C1005 JB 1A 104K-T	B	26.6/22.5
C2049	4030017420	S.CER C1005 CH 1H 470J-T	B	25.7/9.5
C2050	4030017620	S.CER C1005 CH 1H 100C-T	B	26.7/15.8
C2051	4030016930	S.CER C1005 JB 1A 104K-T	B	13.6/29.4
C2052	4030016930	S.CER C1005 JB 1A 104K-T	B	25.5/15.3
C2053	4030017460	S.CER C1005 JB 1H 102K-T	B	27.4/10.4
C2054	4030016930	S.CER C1005 JB 1A 104K-T	T	25.5/12.4
C2055	4030017400	S.CER C1005 CH 1H 220J-T	B	11.0/20.3
C2056	4030017380	S.CER C1005 CH 1H 050B-T	T	27.2/10.7
C2057	4030016930	S.CER C1005 JB 1A 104K-T	B	24.1/10.4
C2058	4030016790	S.CER C1005 JB 1E 103K-T	B	28.8/13.7
C2059	4030017620	S.CER C1005 CH 1H 100C-T	B	18.9/6.2
C2060	4030016780	S.CER C1005 JB 1E 153K-T	B	12.2/11.7
C2062	4030018860	S.CER C1005 JB 0J 105K-T	T	9.4/20.1
C2063	4030017420	S.CER C1005 CH 1H 470J-T	T	2.1/14.7
C206				

[MAIN-B UNIT] (For [High band] versions)

REF NO.	PARTS NO.	DESCRIPTION	M.	H/V LOCATION
EP7	6910018460	S.BEA MMZ1005Y102C-T	B	74.2/19.4
EP8	6910018460	S.BEA MMZ1005Y102C-T	B	80.8/16.7
EP13	6910018460	S.BEA MMZ1005Y102C-T	B	100.1/25.3
EP2001	6910016330	S.BEA MMZ1005S 601CT-S	B	22.8/5.3
EP2003	6910016330	S.BEA MMZ1005S 601CT-S	T	9.1/7.0
EP2004	6910016330	S.BEA MMZ1005S 601CT-S	T	32.7/9.0
EP2005	6910016330	S.BEA MMZ1005S 601CT-S	B	24.6/23.8
EP2007	6910016330	S.BEA MMZ1005S 601CT-S	T	10.8/6.2

[FRONT UNIT]

REF NO.	PARTS NO.	DESCRIPTION	M.	H/V LOCATION
IC6	1130015530	S.IC BU9795AKV-E2	B	59.9/17.4
IC7	1110002751	S.IC TA75S01F(TE85RF)	T	85.8/12.3
IC51	1140015010	S.IC HD64F2506RBR26DV(EMPTY)	B	67.5/21.9
IC52	1130015080	S.IC R1EX24512ASAS0A	B	92.3/15.4
IC53	1130011741	S.IC TC7W66FK(TE85LF)	B	24.3/22.0
IC54	1130007021	S.IC TC7S66FU(TE85LF)	B	28.8/19.5
Q1	1530002851	S.TRA 2SC4116-BL(TE85RF)	B	33.6/16.2
Q2	1590004090	S.TRA LDTC114YET1G <SLVJ>	B	33.7/19.8
Q5	1590004090	S.TRA LDTC114YET1G <SLVJ>	B	33.7/22.3
Q10	1590004090	S.TRA LDTC114YET1G <SLVJ>	B	54.1/21.1
Q95	1590004090	S.TRA LDTC114YET1G <SLVJ>	B	77.6/11.2
Q96	1590004150	S.TRA DRC9114T0L	B	17.1/12.8
Q97	1590004150	S.TRA DRC9114T0L	B	30.7/21.5
D1	1790001990	S.VAR EZJP0V080DA	T	12.4/17.1
D2	1790001990	S.VAR EZJP0V080DA	T	7.0/17.1
D3	1790001990	S.VAR EZJP0V080DA	B	17.7/10.6
D5	1750002170	S.DIO DB2S31400L	B	48.6/6.3
	1750002170	S.DIO DB2S31400L	[EXP-01]	
	1750002170	S.DIO DB2S31400L	[EXP-02]	
	1790001241	S.DIO MA2S7280GL	[USA-01]	
	1750002170	S.DIO DB2S31400L	[USA-02]	
	1790001241	S.DIO MA2S7280GL	[EXP-03]	
	1750002170	S.DIO DB2S31400L	[EXP-04]	
	1790001241	S.DIO MA2S7280GL	[EXP-06]	
	1750002170	S.DIO DB2S31400L	[CHN-01]	
D60	1750001790	S.DIO 1SS390 TE61	B	80.2/13.0
X51	6050013160	S.XTA CR-912 TSS3225A 19.6608 MHz	B	84.0/16.9
L1	6200003640	S.COI MLF1608E 100K-T	B	11.6/17.1
L2	6200001981	S.COI NLV25T-1R0J	B	58.5/9.5
R7	7030005000	S.RES ERJ2GEJ 471 X (470)	B	35.7/16.2
R8	7030005000	S.RES ERJ2GEJ 471 X (470)	B	36.7/16.2
R9	7030007570	S.RES ERJ2GEJ 122 X (1.2K)	B	37.6/16.2
R11	7030009280	S.RES ERJ2GEJ 391 X	B	33.1/18.0
R12	7030009140	S.RES ERJ2GEJ 272 X (2.7K)	B	34.7/18.0
R14	7210003330	VAR RK09D1130A1N		
R15	7030005120	S.RES ERJ2GEJ 102 X (1K)	B	7.2/17.1
R16	7030005120	S.RES ERJ2GEJ 102 X (1K)	B	15.5/12.0
R18	7030005240	S.RES ERJ2GEJ 473 X (47K)	T	5.9/17.1
R19	7030005090	S.RES ERJ2GEJ 104 X (100K)	B	18.7/12.6
R20	7030010040	S.RES ERJ2GEJ-JPW	B	29.7/7.3
R40	7030005040	S.RES ERJ2GEJ 472 X (4.7K)	B	23.0/25.4
R41	7030007340	S.RES ERJ2GEJ 153 X (15K)	B	23.0/27.4
R42	7030005240	S.RES ERJ2GEJ 473 X (47K)	B	26.9/27.8
R43	7030007350	S.RES ERJ2GEJ 393 X (39K)	B	28.8/27.8
R44	7030005170	S.RES ERJ2GEJ 474 X (470K)	B	25.0/26.2
R46	7030004980	S.RES ERJ2GEJ 101 X (100)	B	33.4/3.3
R47	7030007300	S.RES ERJ2GEJ 332 X (3.3K)	B	33.4/5.1
R51	7030005090	S.RES ERJ2GEJ 104 X (100K)	B	51.0/6.3
R60	7030005090	S.RES ERJ2GEJ 104 X (100K)	B	84.0/8.6
R76	7030005120	S.RES ERJ2GEJ 102 X (1K)	T	10.4/17.1
R83	7030005090	S.RES ERJ2GEJ 104 X (100K)	B	40.0/14.7
R85	7030005090	S.RES ERJ2GEJ 104 X (100K)	B	57.7/27.5
R86	7030005090	S.RES ERJ2GEJ 104 X (100K)	B	56.7/25.0
R87	7030005090	S.RES ERJ2GEJ 104 X (100K)	B	59.1/28.1
R88	7030005090	S.RES ERJ2GEJ 104 X (100K)	B	56.3/6.9
R89	7030005090	S.RES ERJ2GEJ 104 X (100K)	B	86.9/19.8
R90	7030005090	S.RES ERJ2GEJ 104 X (100K)	B	86.2/26.0
R243	7030005530	S.RES ERJ2GEJ 100 X (10)	B	80.5/18.4
R244	7030005160	S.RES ERJ2GEJ 105 X (1M)	B	81.9/17.9
R627	7030005090	S.RES ERJ2GEJ 104 X (100K)	B	74.8/17.5
R628	7030005090	S.RES ERJ2GEJ 104 X (100K)	B	58.1/5.6
R631	7030005050	S.RES ERJ2GEJ 103 X (10K)	B	80.8/15.5
R632	7030005050	S.RES ERJ2GEJ 103 X (10K)	B	81.7/13.7
R633	7030005040	S.RES ERJ2GEJ 472 X (4.7K)	B	77.6/12.7
R635	7030005050	S.RES ERJ2GEJ 103 X (10K)	B	86.0/11.0
R636	7030005050	S.RES ERJ2GEJ 103 X (10K)	B	86.6/9.8
R637	7030005120	S.RES ERJ2GEJ 102 X (1K)	B	55.0/24.4
R638	7030005090	S.RES ERJ2GEJ 104 X (100K)	B	77.8/23.8
R639	7030005090	S.RES ERJ2GEJ 104 X (100K)	B	76.6/16.3
R651	7030005120	S.RES ERJ2GEJ 102 X (1K)	B	88.4/9.8
R652	7030005120	S.RES ERJ2GEJ 102 X (1K)	B	70.9/29.6
R657	7030005120	S.RES ERJ2GEJ 102 X (1K)	B	86.0/12.2
R688	7030005120	S.RES ERJ2GEJ 102 X (1K)	B	81.8/22.3
R763	7410001150	S.ARR EXB28V471JX	B	76.0/14.5
R765	7410001130	S.ARR EXB28V102JX	B	63.1/29.6
R767	7410001130	S.ARR EXB28V102JX	B	59.2/24.8
R768	7410001130	S.ARR EXB28V102JX	B	59.2/21.7
R769	7410001130	S.ARR EXB28V102JX	B	59.3/18.0
R770	7410001130	S.ARR EXB28V102JX	B	75.8/26.3
R771	7410001130	S.ARR EXB28V102JX	B	69.4/12.7
R772	7410001130	S.ARR EXB28V102JX	B	77.3/19.1
R773	7030005120	S.RES ERJ2GEJ 102 X (1K)	B	83.4/28.7
R774	7030005120	S.RES ERJ2GEJ 102 X (1K)	B	86.5/23.2
R775	7030005090	S.RES ERJ2GEJ 104 X (100K)	B	59.2/5.6
R776	7030005090	S.RES ERJ2GEJ 104 X (100K)	B	56.0/19.8
R777	7030005090	S.RES ERJ2GEJ 104 X (100K)	B	82.3/23.8
R778	7030005090	S.RES ERJ2GEJ 104 X (100K)	B	76.5/17.2
R779	7030005090	S.RES ERJ2GEJ 104 X (100K)	B	67.3/29.3
R780	7030005210	S.RES ERJ2GEJ 822 X (8.2K)	B	23.0/29.4
R781	7030007340	S.RES ERJ2GEJ 153 X (15K)	B	23.0/28.4
R782	7030005090	S.RES ERJ2GEJ 104 X (100K)	B	75.6/22.7
R783	7030005090	S.RES ERJ2GEJ 104 X (100K)	B	58.5/29.4
R784	7030005240	S.RES ERJ2GEJ 473 X (47K)	B	26.5/18.8
R785	7030005240	S.RES ERJ2GEJ 473 X (47K)	B	30.8/19.3

M.=Mounted side (T: Mounted on the Top side, B: Mounted on the Bottom side)
S.=Surface mount

[FRONT UNIT]

REF NO.	PARTS NO.	DESCRIPTION	M.	H/V LOCATION
C2	4030017420	S.CER C1005 CH 1H 470J-T	B	84.0/7.7
C3	4030017420	S.CER C1005 CH 1H 470J-T	B	28.5/6.1
C4	4030017420	S.CER C1005 CH 1H 470J-T	B	47.2/5.0
C5	4030017420	S.CER C1005 CH 1H 470J-T	B	56.3/4.6
C8	4030017460	S.CER C1005 JB 1H 102K-T	B	13.7/17.1
C9	4030017460	S.CER C1005 JB 1H 102K-T	T	11.3/17.1
C10	4030017460	S.CER C1005 JB 1H 102K-T	T	20.3/13.1
C12	4030017460	S.CER C1005 JB 1H 102K-T	T	18.3/13.1
C25	4030016790	S.CER C1005 JB 1E 103K-T	B	26.9/28.9
C26	4030016930	S.CER C1005 JB 1A 104K-T	B	23.0/26.4
C27	4030017680	S.CER C1005 CH 1H 820J-T	B	25.0/27.1
C28	4030016930	S.CER C1005 JB 1A 104K-T	B	30.6/27.1
C31	4030016930	S.CER C1005 JB 1A 104K-T	B	33.4/4.2
C34	4030017420	S.CER C1005 CH 1H 470J-T	B	56.3/5.5
C41	4030017460	S.CER C1005 JB 1H 102K-T	B	25.0/29.0
C50	4030017420	S.CER C1005 CH 1H 470J-T	B	61.6/8.6
C75	4030016930	S.CER C1005 JB 1A 104K-T	B	43.8/14.7
C76	4030016930	S.CER C1005 JB 1A 104K-T	B	28.8/28.9
C78	4030017460	S.CER C1005 JB 1H 102K-T	B	8.9/17.1
C84	4030017420	S.CER C1005 CH 1H 470J-T	B	29.9/2.9
C87	4030016930	S.CER C1005 JB 1A 104K-T	B	30.9/18.0
C93	4030017460	S.CER C1005 JB 1H 102K-T	B	56.3/7.9
C114	4030017420	S.CER C1005 CH 1H 470J-T	B	19.7/10.6
C126	4030017460	S.CER C1005 JB 1H 102K-T	B	25.2/4.2
C128	4030016930	S.CER C1005 JB 1A 104K-T	T	14.6/19.3
C129	4030017460	S.CER C1005 JB 1H 102K-T	T	13.7/19.3
C130	4030017460	S.CER C1005 JB 1H 102K-T	B	85.7/8.6
C131	4030017460	S.CER C1005 JB 1H 102K-T	B	86.9/21.0
C132	4030017460	S.CER C1005 JB 1H 102K-T	B	86.2/26.9
C626	4030017640	S.CER C1005 CH 1H 150J-T	B	81.1/19.6
C627	4030017580	S.CER C1005 CH 1H 060C-T	B	80.0/17.0
C628	4030017640	S.CER C1005 CH 1H 150J-T	B	81.0/17.0
C629	4030016930	S.CER C1005 JB 1A 104K-T	B	79.4/15.1
C630	4030016930	S.CER C1005 JB 1A 104K-T	B	76.2/12.3
C631	4030016930	S.CER C1005 JB 1A 104K-T	B	56.1/29.6
C797	4030016930	S.CER C1005 JB 1A 104K-T	B	75.6/21.5
C799	4030016930	S.CER C1005 JB 1A 104K-T	B	77.2/22.4
C800	4030016930	S.CER C1005 JB 1A 104K-T	B	77.2/21.2
C802	4030016930	S.CER C1005 JB 1A 104K-T	B	64.7/9.9
C803	4030019990	S.CER C1005 JB 1C 104K-T	B	49.7/24.9
C804	4030017460	S.CER C1005 JB 1H 102K-T	B	26.6/22.1
C805	4030018900	S.CER C1005 JB 0J 474K-T	B	65.3/29.3
C806	4550006970	S.TAN TEESVA0G476M8R	B	43.4/6.5
C807	4030016930	S.CER C1005 JB 1A 104K-T	B	75.4/20.4
C808	4030016930	S.CER C1005 JB 1A 104K-T	B	78.8/17.1
C809	4030016930	S.CER C1005 JB 1A 104K-T	B	88.6/15.1
C810	4030016930	S.CER C1005 JB 1A 104K-T	B	25.0/28.1
C811	4030017460	S.CER C1005 JB 1H 102K-T	B	31.5/8.0
J1	6450002210	CON 3017-8821 <KIN>	B	71.0/5.7
J2	6510027960	S.CON 04-6294-040-000-800	B	
J3	6510025142	S.CON 10FLT-SM2-TB(LF)(SN)(M)	B	51.6/28.5
DS1	5040003510	S.LED LNJ426W83RA	T	64.8/23.5
DS2	5040003510	S.LED LNJ426W83RA	T	58.2/23.5
DS3	5040003510	S.LED LNJ426W83RA	T	51.6/23.5
DS4	5040003510	S.LED LNJ426W83RA	T	31.8/23.5
DS5	5040003510	S.LED LNJ426W83RA	T	38.4/23.5
DS6	5040003510	S.LED LNJ426W83RA	T	45.0/23.5
DS7	5040003510	S.LED LNJ426W83RA	T	82.6/22.1
DS8	5040003510	S.LED LNJ426W83RA	T	65.3/5.0
DS9	5040003510	S.LED LNJ426W83RA	T	36.3/5.0
DS11	5030003390	LCD TAK-35877 FX-3331<ITAK>		
SP1	2510001221	SPE C052SB500-14 <OSC>		
W1	8900010503	CAB OPC-1046B-1(P0.5N40L55)<TJM>		
EP2	8930059170	LCD SRCN-2622-SP-N-W (SHJ)		

[MAIN-C UNIT] (For [350 MHz band] versions)

REF NO.	PARTS NO.	DESCRIPTION	M.	H/V LOCATION
IC2	1110002751	S.IC TA75S01F(TE85RF)	T	60.0/54.9
IC3	1150002231	IC RA55H3340M-121		
IC4	1110007320	S.IC NJM2591V-TE1-#ZZZB	T	57.8/24.7
IC5	1110006230	S.IC NJM2711F-TE1-#ZZZB	B	38.8/27.0
IC6	1110002751	S.IC TA75S01F(TE85RF)	B	59.9/17.4
IC7	1130011741	S.IC TC7W66FK(TE85LF)	T	85.8/12.3
IC8	1130015270	S.IC AK1541P-L	B	78.2/23.7
IC1001	1180003660	S.REG XC6408EN22PR-G	B	96.9/10.8
IC1002	1180003500	S.REG NJM7808DL1A-TE1-#FZZB	T	123.3/45.7
IC1004	1110002751	S.IC TA75S01F(TE85RF)	B	119.7/13.0
IC1005	1110007630	S.IC NJM2783V-TE1-#ZZZH	T	47.4/18.9
IC1006	1110007290	S.IC AK2330P-L	B	53.7/11.5
IC1007	1110005320	S.IC NJM13403V-TE1-#ZZZB	B	37.4/17.0
IC1008	1130009981	S.IC TC7W53FK(TE85LF)	T	40.3/19.7
IC1009	1110003091	IC LA4425A-E		
IC2001	1180003680	S.REG TPS62204DBVR	B	32.4/6.5
IC2002	1190002900	S.IC AD57886SDCKR	B	14.4/9.3
IC2006	1110007770	S.IC PCM3008T/2K	T	16.3/8.3
IC2007	1140013290	S.IC TMS320VC5509AZHH	T	18.0/18.4
IC2008	1130015620	S.IC EN25Q40-100GIP <MSK>	B	12.5/25.3
IC2009	1110006230	S.IC NJM2711F-TE1-#ZZZB	B	26.7/12.7
IC2010	1180003600	S.REG NJM2871BF05-TE1-#ZZZB	B	39.0/6.8
Q1	1590004090	S.TRA LDTC114YET1G <SLVJ>	B	47.2/27.1
Q2	1580000731	S.FET 3SK293(TE85LF)	B	41.5/38.7
Q3	1560000541	S.FET 2SK880-Y(T5RICOMF)	T	77.2/24.5
Q4	1530002851	S.TRA 2SC4116-BL(TE85RF)	B	67.9/25.4
Q5	1530002851	S.TRA 2SC4116-BL(TE85RF)	T	44.9/25.3
Q6	1590004090	S.TRA LDTC114YET1G <SLVJ>	T	62.2/52.2
Q7	1560000841	S.FET 2SK1829(TE85RF)	T	33.7/39.7
Q8	1530002680	S.TRA 2SC3357-T1	B	90.4/52.8
Q9	1560001360	S.FET 2SK3019 TL	T	52.2/36.0
Q10	1530003311	S.TRA 2SC5107-O(TE85RF)	B	92.8/33.1
Q11	1530003311	S.TRA 2SC5107-O(TE85RF)	B	100.5/31.7
Q12	1530004110	S.TRA MT3S37T(TE85LF)	B	97.6/30.4
Q13	1590004090	S.TRA LDTC114YET1G <SLVJ>	B	57.6/27.2
Q14	1530003311	S.TRA 2SC5107-O(TE85RF)	T	64.8/32.9
Q15	1590004500	S.TRA DMC561040R	T	101.0/34.4
Q17	1530002851	S.TRA 2SC4116-BL(TE85RF)	T	107.7/33.4
Q18	1590004090	S.TRA LDTC114YET1G <SLVJ>	T	81.5/40.8
Q19	1580000731	S.FET 3SK293(TE85LF)	B	71.4/38.4
Q20	1530002851	S.TRA 2SC4116-BL(TE85RF)	T	60.0/49.8
Q21	1590004090	S.TRA LDTC114YET1G <SLVJ>	T	49.5/24.8
Q23	1530002921	S.TRA 2SC4226-T1 Y25 (R25)	B	105.2/30.9
Q24	1530002921	S.TRA 2SC4226-T1 Y25 (R25)	B	98.3/24.2
Q25	1530003260	S.TRA 2SC5006-T1	B	84.9/51.5
Q1001	1590004090	S.TRA LDTC114YET1G <SLVJ>	T	110.6/44.1
Q1003	1550000190	S.FET 2SJ506STR-E	T	115.3/45.4
Q1004	1590004090	S.TRA LDTC114YET1G <SLVJ>	T	114.0/26.7
Q1005	1590004090	S.TRA LDTC114YET1G <SLVJ>	T	114.0/24.7
Q1007	1590004090	S.TRA LDTC114YET1G <SLVJ>	B	116.3/8.1
Q1008	1590000990	S.TRA DTC363EK T146	B	128.9/17.8
Q1009	1590001451	S.FET 2SJ144-GR (TE85RF)	B	113.8/11.1
Q1010	1590004090	S.TRA LDTC114YET1G <SLVJ>	B	116.1/10.9
Q1011	1540000550	S.TRA 2SD1664 T100Q	B	125.1/47.6
Q1012	1590004090	S.TRA LDTC114YET1G <SLVJ>	B	130.9/20.7
Q1013	1510000920	S.TRA 2SA1577 T106 Q	T	107.7/44.3
Q1014	1520000460	S.TRA 2SB1132 T100 R	B	123.5/21.1
Q1015	1590004590	S.TRA DMC506010R	B	118.9/20.4
Q1016	1590004090	S.TRA LDTC114YET1G <SLVJ>	T	107.8/39.2
Q1017	1520000460	S.TRA 2SB1132 T100 R	T	120.1/35.2
Q1018	1590004090	S.TRA LDTC114YET1G <SLVJ>	B	126.4/43.3
Q1019	1590004590	S.TRA DMC506010R	B	123.8/35.8
Q1020	1590004090	S.TRA LDTC114YET1G <SLVJ>	T	42.6/22.5
Q1021	1590004090	S.TRA LDTC114YET1G <SLVJ>	B	126.4/41.3
Q2001	1590004040	S.TRA LDTA123YET1G <SLVJ>	B	26.9/26.6
D2	1750001910	S.DIO HVD144AKRF-E	B	52.6/28.5
D3	1750001910	S.DIO HVD144AKRF-E	B	52.6/27.3
D4	1750000711	S.VAR HVC350BTRF-E	B	36.0/40.2
D5	1750002060	S.DIO RN752TE-21	T	26.5/53.3
D7	1750001910	S.DIO HVD144AKRF-E	B	25.3/45.3
D8	1750001910	S.DIO HVD144AKRF-E	B	43.4/27.3
D9	1750001910	S.DIO HVD144AKRF-E	B	43.4/28.6
D10	1750000711	S.VAR HVC350BTRF-E	B	55.5/39.9
D11	1750001820	S.DIO LRB706F-40T1G <SLVJ>	B	8.2/49.9
D12	1750001820	S.DIO LRB706F-40T1G <SLVJ>	B	22.8/49.9
D13	1750001910	S.DIO HVD144AKRF-E	T	68.3/28.1
D14	1750001910	S.DIO HVD144AKRF-E	T	69.5/28.1
D15	1790001261	S.DIO MA2S077G0L	B	82.2/39.2
D16	1750000711	S.VAR HVC350BTRF-E	B	106.7/20.3
D17	1750001910	S.DIO HVD144AKRF-E	T	70.6/41.6
D18	1750001910	S.DIO HVD144AKRF-E	T	74.5/41.6
D19	1750000711	S.VAR HVC350BTRF-E	B	61.9/39.9
D20	1750000711	S.VAR HVC350BTRF-E	B	28.0/40.2
D21	1750000711	S.VAR HVC350BTRF-E	B	36.0/41.6
D22	1750000711	S.VAR HVC350BTRF-E	B	28.0/41.6
D23	1750000711	S.VAR HVC350BTRF-E	B	52.8/42.6
D24	1750002060	S.DIO RN752TE-21	T	35.1/56.7
D25	1750000581	S.DIO 1SV307(TPH3F)	B	83.5/42.1
D26	1750001650	S.VAR 1SV309(TPH3F)	B	101.8/25.9
D29	1750001820	S.DIO LRB706F-40T1G <SLVJ>	B	19.2/49.9
D33	1750000711	S.VAR HVC350BTRF-E	B	97.8/20.5
D62	1750000711	S.VAR HVC350BTRF-E	B	91.7/22.8
D64	1750000711	S.VAR HVC350BTRF-E	B	106.7/21.5
D66	1750000370	S.DIO DA221 TL	T	33.7/37.1
D67	1790001241	S.DIO MA2S7280GL	T	31.8/39.7
D1002	1790000700	DIO DSA3A1		
D1003	1750000370	S.DIO DA221 TL	B	114.0/8.2
D1004	1750000370	S.DIO DA221 TL	B	114.1/6.1
D1005	1750000370	S.DIO DA221 TL	T	113.2/7.4
D1006	1750000370	S.DIO DA221 TL	T	113.0/10.3
D1007	1750001810	S.DIO L1SS400T1G <SLVJ>	B	129.0/20.7

M.=Mounted side (T: Mounted on the Top side, B: Mounted on the Bottom side)
S.=Surface mount

[MAIN-C UNIT] (For [350 MHz band] versions)

REF NO.	PARTS NO.	DESCRIPTION	M.	H/V LOCATION
R619	7030005030	S.RES ERJ2GGEJ 152 X (1.5K)	B	36.0/27.5
R620	7030005240	S.RES ERJ2GGEJ 473 X (47K)	B	57.4/18.4
R621	7410001130	S.ARR EXB28V102JX	B	76.6/19.6
R622	7030007570	S.RES ERJ2GGEJ 122 X (1.2K)	B	83.8/21.6
R623	7030005090	S.RES ERJ2GGEJ 104 X (100K)	T	50.7/26.1
R624	7030005090	S.RES ERJ2GGEJ 104 X (100K)	T	83.2/11.6
R625	7030010040	S.RES ERJ2GGEJ-JPW	B	96.1/20.1
R1003	7030007601	S.RES ERA3YKD 913V (91K)	B	72.6/9.4
R1004	7030006101	S.RES ERA3YED 183V (18K)	B	70.2/10.2
R1005	7030005120	S.RES ERJ2GGEJ 102 X (1K)	T	112.3/16.5
R1006	7030005090	S.RES ERJ2GGEJ 104 X (100K)	B	112.4/8.1
R1008	7030010040	S.RES ERJ2GGEJ-JPW	T	124.9/24.8
R1009	7030005050	S.RES ERJ2GGEJ 103 X (10K)	T	133.3/49.2
R1010	7030005050	S.RES ERJ2GGEJ 103 X (10K)	T	128.6/20.8
R1012	7030005040	S.RES ERJ2GGEJ 472 X (4.7K)	T	110.6/46.0
R1013	7030005240	S.RES ERJ2GGEJ 473 X (47K)	T	114.7/49.0
R1014	7030005090	S.RES ERJ2GGEJ 104 X (100K)	T	98.3/12.1
R1015	7030005120	S.RES ERJ2GGEJ 102 X (1K)	B	115.3/22.8
R1016	7030005090	S.RES ERJ2GGEJ 104 X (100K)	B	115.6/6.1
R1018	7030005090	S.RES ERJ2GGEJ 104 X (100K)	T	111.7/7.0
R1020	7030005090	S.RES ERJ2GGEJ 104 X (100K)	B	114.7/24.9
R1021	7030005120	S.RES ERJ2GGEJ 102 X (1K)	B	116.5/6.1
R1022	7030005120	S.RES ERJ2GGEJ 102 X (1K)	T	114.9/7.1
R1023	7030005050	S.RES ERJ2GGEJ 103 X (10K)	B	125.2/15.7
R1024	7030007290	S.RES ERJ2GGEJ 222 X (2.2K)	B	131.6/17.6
R1025	7030000480	S.RES MCR10EZHJ 6.8K (682)	B	129.4/47.0
R1026	7030000480	S.RES MCR10EZHJ 6.8K (682)	B	129.4/48.8
R1027	7030010040	S.RES ERJ2GGEJ-JPW	T	113.7/16.5
R1028	7030004970	S.RES ERJ2GGEJ 470 X (47)	B	114.9/13.4
R1029	7030005120	S.RES ERJ2GGEJ 102 X (1K)	T	115.3/10.5
R1030	7030005050	S.RES ERJ2GGEJ 103 X (10K)	T	114.4/10.5
R1031	7030005050	S.RES ERJ2GGEJ 103 X (10K)	B	117.8/7.7
R1032	7030005050	S.RES ERJ2GGEJ 103 X (10K)	B	127.1/19.9
R1033	7030000480	S.RES MCR10EZHJ 6.8K (682)	B	129.4/45.2
R1034	7030005040	S.RES ERJ2GGEJ 472 X (4.7K)	B	123.6/17.5
R1035	7030005050	S.RES ERJ2GGEJ 103 X (10K)	T	107.8/42.5
R1036	7030005040	S.RES ERJ2GGEJ 472 X (4.7K)	T	107.8/41.2
R1037	7030005090	S.RES ERJ2GGEJ 104 X (100K)	T	95.9/13.5
R1038	7030005120	S.RES ERJ2GGEJ 102 X (1K)	B	125.6/36.3
R1039	7030005090	S.RES ERJ2GGEJ 104 X (100K)	B	113.7/12.9
R1040	7030005160	S.RES ERJ2GGEJ 105 X (1M)	T	111.2/12.9
R1043	7030005160	S.RES ERJ2GGEJ 105 X (1M)	B	112.0/11.0
R1044	7030005090	S.RES ERJ2GGEJ 104 X (100K)	B	117.9/9.9
R1045	7030005050	S.RES ERJ2GGEJ 103 X (10K)	B	120.4/17.1
R1046	7030005800	S.RES RR0510P-102-D (100K)	B	119.7/9.0
R1047	7030005050	S.RES ERJ2GGEJ 103 X (10K)	B	119.4/18.6
R1048	7030009710	S.RES ERJ2GGEJ 203 X (20K)	B	119.0/22.4
R1049	7030005040	S.RES ERJ2GGEJ 472 X (4.7K)	B	116.7/17.7
R1050	7030007290	S.RES ERJ2GGEJ 222 X (2.2K)	B	123.0/38.1
R1054	7030008270	S.RES RR0510P-104-D (100K)	B	119.7/9.9
R1055	7030005090	S.RES ERJ2GGEJ 104 X (100K)	B	120.4/15.2
R1056	7030008270	S.RES RR0510P-104-D (100K)	B	118.8/10.8
R1057	7030005100	S.RES ERJ2GGEJ 154 X (150K)	B	118.8/15.4
R1059	7410001130	S.ARR EXB28V102JX	T	69.7/14.8
R1060	7410001130	S.ARR EXB28V102JX	T	63.4/14.8
R1062	7030008270	S.RES RR0510P-104-D (100K)	B	116.0/14.8
R1063	7030007340	S.RES ERJ2GGEJ 153 X (15K)	B	42.8/22.4
R1064	7030005090	S.RES ERJ2GGEJ 104 X (100K)	T	40.5/23.1
R1068	7030005120	S.RES ERJ2GGEJ 102 X (1K)	T	74.3/14.1
R1069	7030005120	S.RES ERJ2GGEJ 102 X (1K)	T	72.6/14.1
R1070	7030005120	S.RES ERJ2GGEJ 102 X (1K)	T	57.3/15.1
R1071	7030005090	S.RES ERJ2GGEJ 104 X (100K)	T	51.7/16.7
R1072	7030005040	S.RES ERJ2GGEJ 472 X (4.7K)	T	52.9/16.3
R1073	7030005700	S.RES ERJ2GGEJ 274 X (270K)	B	50.8/18.7
R1074	7030005100	S.RES ERJ2GGEJ 154 X (150K)	B	32.7/20.6
R1075	7030008010	S.RES ERJ2GGEJ 123 X (12K)	T	36.3/21.5
R1076	7030005090	S.RES ERJ2GGEJ 104 X (100K)	B	35.0/20.5
R1077	7030005170	S.RES ERJ2GGEJ 474 X (470K)	B	36.6/20.2
R1078	7030005090	S.RES ERJ2GGEJ 104 X (100K)	B	32.2/15.2
R1080	7030005310	S.RES ERJ2GGEJ 124 X (120K)	B	40.1/13.5
R1081	7030008290	S.RES ERJ2GGEJ 183 X (18K)	T	42.5/19.5
R1082	7410001130	S.ARR EXB28V102JX	T	56.9/6.7
R1083	7030005120	S.RES ERJ2GGEJ 102 X (1K)	B	69.1/8.8
R1084	7410001130	S.ARR EXB28V102JX	T	61.7/6.1
R1085	7030005120	S.RES ERJ2GGEJ 102 X (1K)	B	49.5/9.9
R1086	7030005100	S.RES ERJ2GGEJ 154 X (150K)	B	32.2/18.5
R1087	7030007340	S.RES ERJ2GGEJ 153 X (15K)	B	31.3/15.2
R1088	7030005160	S.RES ERJ2GGEJ 105 X (1M)	B	31.3/16.9
R1089	7030005050	S.RES ERJ2GGEJ 103 X (10K)	B	44.2/16.9
R1090	7030008300	S.RES ERJ2GGEJ 184 X (180K)	B	36.5/13.4
R1092	7030008400	S.RES ERJ2GGEJ 182 X (1.8K)	B	38.3/13.5
R1093	7030005090	S.RES ERJ2GGEJ 104 X (100K)	B	42.9/15.5
R1094	7030005090	S.RES ERJ2GGEJ 104 X (100K)	T	55.7/12.8
R1095	7030009290	S.RES ERJ2GGEJ 562 X (5.6K)	T	55.7/13.7
R1096	7030005100	S.RES ERJ2GGEJ 154 X (150K)	B	35.6/13.4
R1097	7030007290	S.RES ERJ2GGEJ 222 X (2.2K)	T	55.2/11.2
R1098	7510001730	S.THE ERTJJOEP 473J	T	74.9/15.5
R1099	7030008270	S.RES RR0510P-104-D (100K)	T	72.5/15.5
R1100	7410001130	S.ARR EXB28V102JX	T	75.3/6.0
R1101	7030005290	S.RES ERJ2GGEJ 682 X (6.8K)	B	44.0/20.4
R1102	7030005050	S.RES ERJ2GGEJ 103 X (10K)	B	42.4/16.4
R1103	7030005290	S.RES ERJ2GGEJ 682 X (6.8K)	B	52.9/18.3
R1104	7030003220	S.RES ERJ3GEVJ 150 V (15)	?	
R1105	7030003220	S.RES ERJ3GEVJ 150 V (15)	T	127.8/48.9
R1106	7030009290	S.RES ERJ2GGEJ 562 X (5.6K)	B	41.0/20.8
R1107	7030008410	S.RES ERJ2GGEJ 392 X (3.9K)	B	39.2/20.8
R1108	7030005240	S.RES ERJ2GGEJ 473 X (47K)	B	124.9/41.7
R1111	7030005060	S.RES ERJ2GGEJ 333 X (33K)	T	36.3/19.7
R1112	7030005230	S.RES ERJ2GGEJ 334 X (330K)	B	41.5/19.6
R1113	7030005720	S.RES ERJ2GGEJ 563 X (56K)	B	44.0/21.3
R1114	7030005120	S.RES ERJ2GGEJ 102 X (1K)	T	65.8/6.4
R1115	7030005120	S.RES ERJ2GGEJ 102 X (1K)	T	65.8/5.4
R1116	7030007300	S.RES ERJ2GGEJ 332 X (3.3K)	T	73.7/15.0
R1117	7030005090	S.RES ERJ2GGEJ 104 X (100K)	B	42.4/18.2
R2003	7030007250	S.RES ERJ2GGEJ 220 X (22)	B	16.7/6.8

[MAIN-C UNIT] (For [350 MHz band] versions)

REF NO.	PARTS NO.	DESCRIPTION	M.	H/V LOCATION
R2004	7030005210	S.RES ERJ2GGEJ 822 X (8.2K)	B	12.6/8.8
R2005	7030005210	S.RES ERJ2GGEJ 822 X (8.2K)	B	15.8/6.8
R2009	7030007290	S.RES ERJ2GGEJ 222 X (2.2K)	B	10.5/11.7
R2010	7030004980	S.RES ERJ2GGEJ 101 X (100)	T	11.5/11.7
R2011	7030004980	S.RES ERJ2GGEJ 101 X (100)	T	23.0/10.4
R2012	7030004980	S.RES ERJ2GGEJ 101 X (100)	T	22.5/11.3
R2013	7030005240	S.RES ERJ2GGEJ 473 X (47K)	B	19.8/12.0
R2015	7030005240	S.RES ERJ2GGEJ 473 X (47K)	T	18.4/11.6
R2016	7030010040	S.RES ERJ2GGEJ-JPW	B	24.0/5.8
R2019	7030010040	S.RES ERJ2GGEJ-JPW	B	9.9/17.9
R2020	7030010040	S.RES ERJ2GGEJ-JPW	B	14.4/11.1
R2021	7030004980	S.RES ERJ2GGEJ 101 X (100)	B	23.6/12.1
R2022	7030004980	S.RES ERJ2GGEJ 101 X (100)	B	27.9/24.7
R2024	7030005240	S.RES ERJ2GGEJ 473 X (47K)	B	26.6/21.6
R2026	7030004970	S.RES ERJ2GGEJ 470 X (47)	B	27.9/22.9
R2028	7030005240	S.RES ERJ2GGEJ 473 X (47K)	B	12.1/19.3
R2030	7030005240	S.RES ERJ2GGEJ 473 X (47K)	B	11.0/21.2
R2031	7030005240	S.RES ERJ2GGEJ 473 X (47K)	B	10.7/29.4
R2032	7030005240	S.RES ERJ2GGEJ 473 X (47K)	B	24.9/17.4
R2034	7030005240	S.RES ERJ2GGEJ 473 X (47K)	B	28.8/10.5
R2035	7030005240	S.RES ERJ2GGEJ 473 X (47K)	B	26.7/14.9
R2036	7030004980	S.RES ERJ2GGEJ 101 X (100)	T	26.8/11.9
R2037	7030007290	S.RES ERJ2GGEJ 222 X (2.2K)	T	28.1/10.7
R2038	7030004970	S.RES ERJ2GGEJ 470 X (47)	B	28.8/12.1
R2039	7030005240	S.RES ERJ2GGEJ 473 X (47K)	B	24.1/9.5
R2040	7030005240	S.RES ERJ2GGEJ 473 X (47K)	B	24.5/12.1
R2043	7410001140	S.ARR EXB28V104JX	T	15.6/26.7
R2044	7410001140	S.ARR EXB28V104JX	B	20.8/26.3
R2045	7410001140	S.ARR EXB28V104JX	T	27.0/22.6
R2046	7410001140	S.ARR EXB28V104JX	T	19.3/26.7
R2047	7410001140	S.ARR EXB28V104JX	B	10.9/14.5
R2048	7030005090	S.RES ERJ2GGEJ 104 X (100K)	T	25.7/14.6
R2049	7030005090	S.RES ERJ2GGEJ 104 X (100K)	B	21.8/15.6
R2050	7410001140	S.ARR EXB28V104JX	B	22.6/18.2
R2051	7410001140	S.ARR EXB28V104JX	T	9.9/17.6
R2052	7030005090	S.RES ERJ2GGEJ 104 X (100K)	T	16.8/11.6
R2053	7030005090	S.RES ERJ2GGEJ 104 X (100K)	B	16.0/14.5
R2056	7030010040	S.RES ERJ2GGEJ-JPW	T	10.6/20.0
R2057	7030005090	S.RES ERJ2GGEJ 104 X (100K)	T	10.4/22.9
R2058	7410001140	S.ARR EXB28V104JX	B	17.0/18.6
R2059	7030005090	S.RES ERJ2GGEJ 104 X (100K)	T	10.4/23.8
R2060	7030005090	S.RES ERJ2GGEJ 104 X (100K)	T	25.7/15.6
R2061	7030005090	S.RES ERJ2GGEJ 104 X (100K)	B	14.7/12.6
R2062	7030005090	S.RES ERJ2GGEJ 104 X (100K)	B	17.7/14.4
R2063	7030005090	S.RES ERJ2GGEJ 104 X (100K)	B	22.1/23.4
R2064	7030005090	S.RES ERJ2GGEJ 104 X (100K)	B	19.7/17.7
R2065	7030005030	S.RES ERJ2GGEJ 152 X (1.5K)	B	13.8/8.6
R2066	7410001170	S.ARR EXB28V470JX	T	21.3/6.7
R2067	7030010040	S.RES ERJ2GGEJ-JPW	T	11.4/5.3
R2068	7030010040	S.RES ERJ2GGEJ-JPW	T	20.9/10.4
R2071	7030010040	S.RES ERJ2GGEJ-JPW	T	24.9/5.7
R2072	7030005050	S.RES ERJ2GGEJ 103 X (10K)	B	12.2/10.1
R2074	7030010040	S.RES ERJ2GGEJ-JPW	T	8.7/10.0
R2084	7030010040	S.RES ERJ2GGEJ-JPW	T	30.7/10.5
R2085	7030010040	S.RES ERJ2GGEJ-JPW	B	19.5/9.6
C1	4030011080	S.CER GRM31M2C2H6R0DV01L (GRM42-6 CH)	B	8.4/66.6
C2	4030011080	S.CER GRM31M2C2H6R0DV01L (GRM42-6 CH)	B	7.4/58.6
C3	4030009500	S.CER C1608 CH 1H 0R5B-T	B	25.6/51.9
C4	4030009500	S.CER C1608 CH 1H 0R5B-T	B	16.4/51.9
C5	4030009500	S.CER C1608 CH 1H 0R5B-T	B	8.2/54.5
C6	4030011100	S.CER GRM31M2C2H8R0DV01L (GRM42-6 CH)	B	7.4/56.3
C7	4030011110	S.CER GRM31M2C2H9R0DV01L (GRM42-6 CH)	B	13.1/60.7
C8	4030011100	S.CER GRM31M2C2H8R0DV01L (GRM42-6 CH)	B	19.5/60.7
C9	4030011100	S.CER GRM31M2C2H8R0DV01L (GRM42-6 CH)	T	30.6/53.1
C10	4030017730	S.CER C1005 JB 1H 471K-T	B	18.1/48.1
C11	4030017730	S.CER C1005 JB 1H 471K-T	B	10.0/49.0
C12	4030017730	S.CER C1005 JB 1H 471K-T	T	39.4/54.4
C13	4030017420	S.CER C1005 CH 1H 470J-T	B	49.5/51.4
C14	4030019420	S.CER GRM31A7U2J102JW31D	B	34.9/55.5
C15	4030017360	S.CER C1005 CH 1H 030B-T	T	23.7/50.4
C20	4030017670	S.CER C1005 CH 1H 390J-T	B	30.6/40.5
C21				

[MAIN-C UNIT] (For [350 MHz band] versions)

Table with columns: REF NO., PARTS NO., DESCRIPTION, M., H/V LOCATION. Contains component list for 350 MHz band versions (MAIN-C UNIT).

[MAIN-C UNIT] (For [350 MHz band] versions)

Table with columns: REF NO., PARTS NO., DESCRIPTION, M., H/V LOCATION. Contains component list for 350 MHz band versions (MAIN-C UNIT), including additional components like J1001, W1, EP1.

M.=Mounted side (T: Mounted on the Top side, B: Mounted on the Bottom side) S.=Surface mount

BOARD LAYOUTS

The combination of top side and bottom side of this page shows the actual configuration of P.C. board.

**• MAIN-A/MAIN-B/MAIN-C UNIT
(TOP VIEW)**

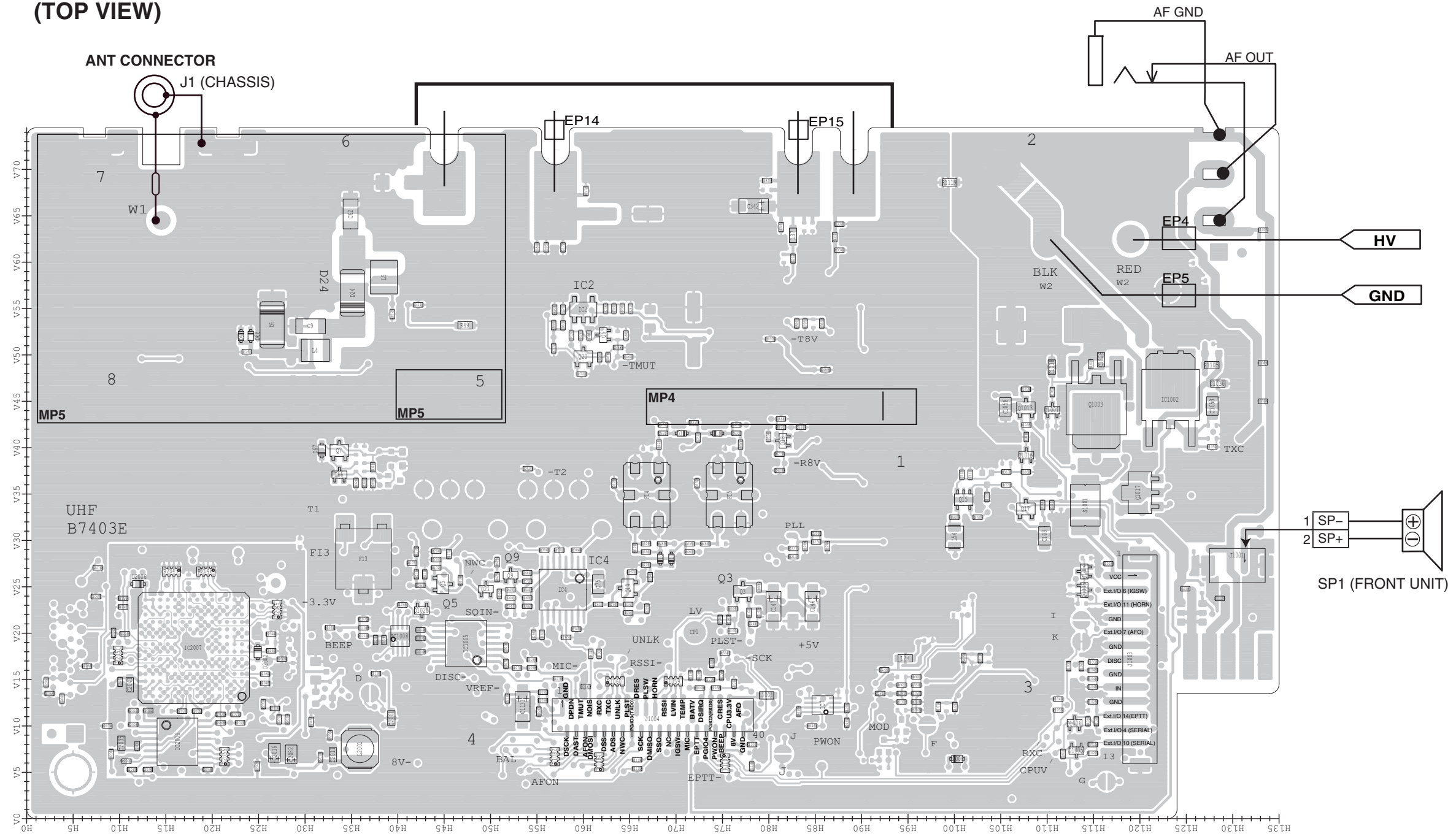

• MAIN-A/MAIN-B/MAIN-C UNIT
(BOTTOM VIEW)

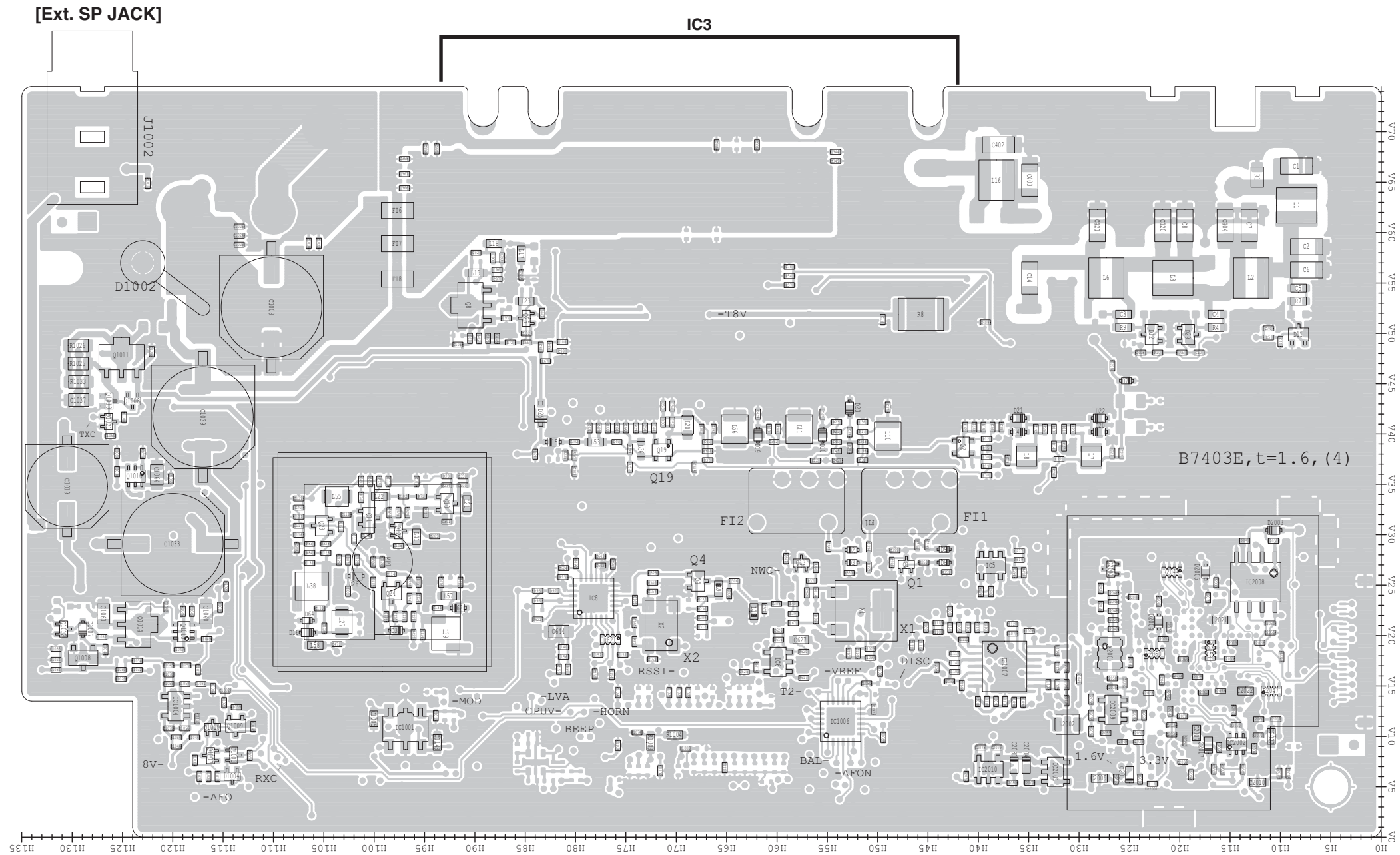

VOLTAGE DIAGRAM

• MAIN-A/MAIN-B/MAIN-C UNIT (1/3)

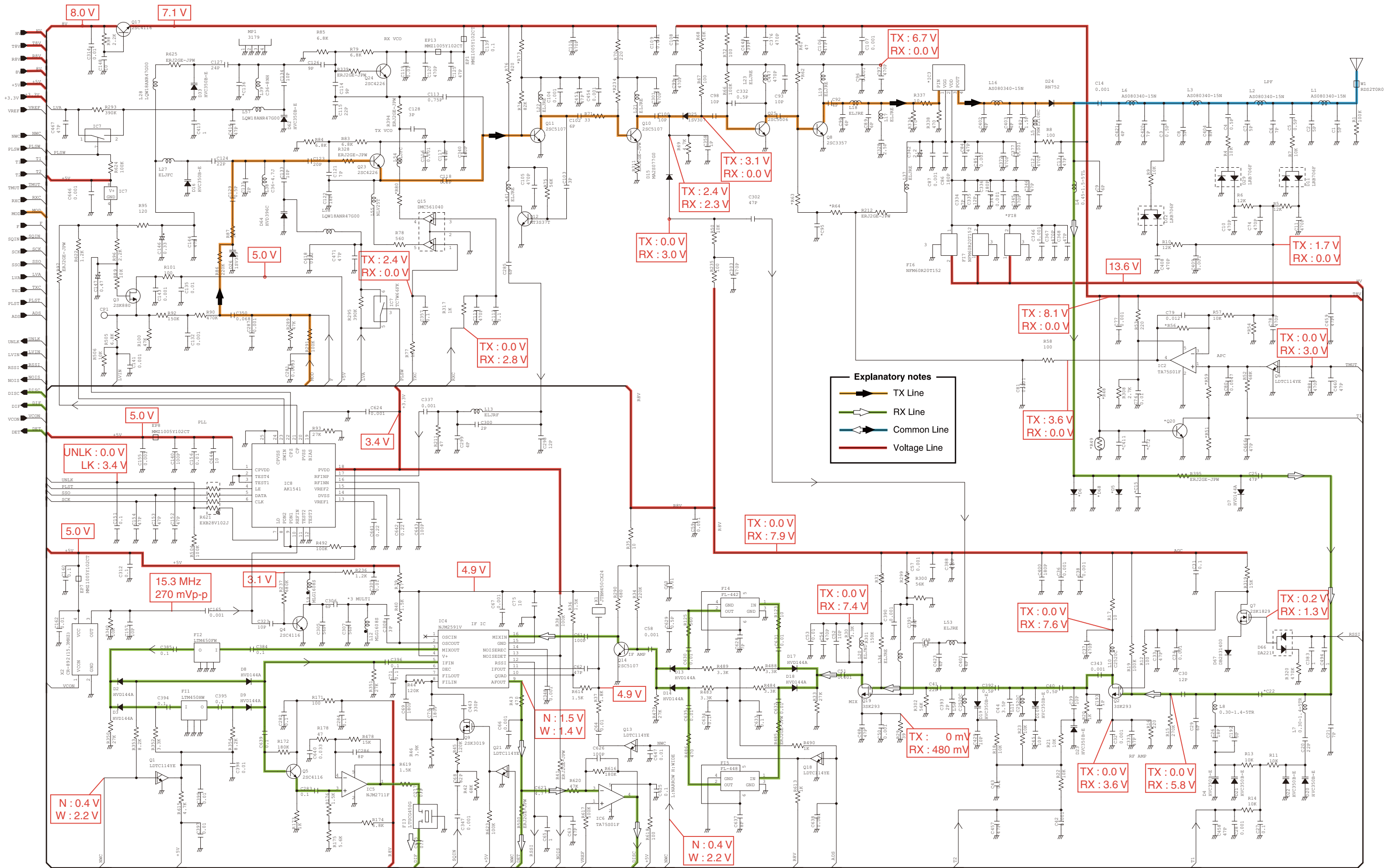

Explanatory notes

- TX Line
- RX Line
- Common Line
- Voltage Line

*: Refer to the PARTS LIST for the value and name of component.

• MAIN-A/MAIN-B/MAIN-C UNIT (2/3)

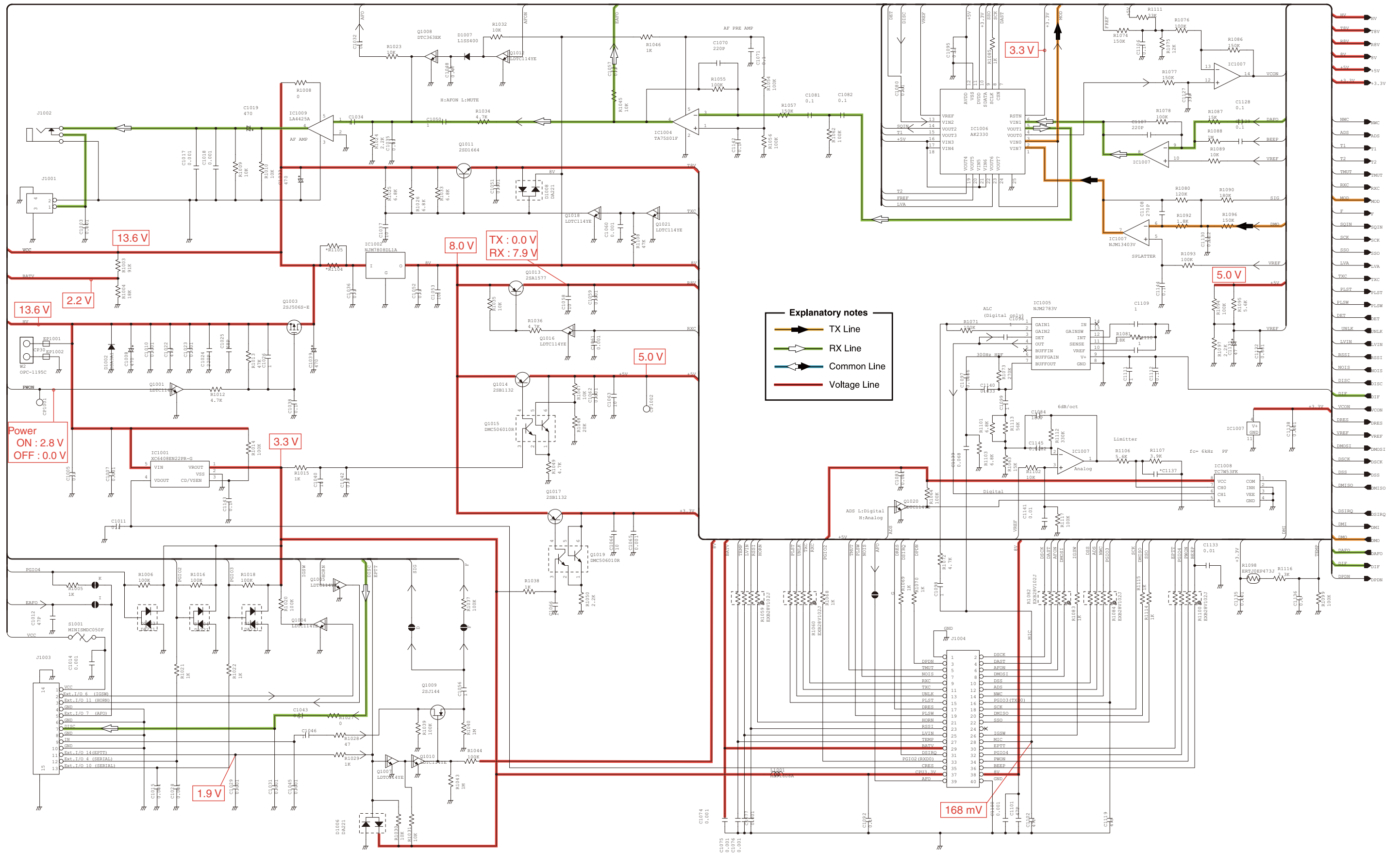

*: Refer to the PARTS LIST for the value and name of component.

• MAIN-A/MAIN-B/MAIN-C UNIT (3/3)

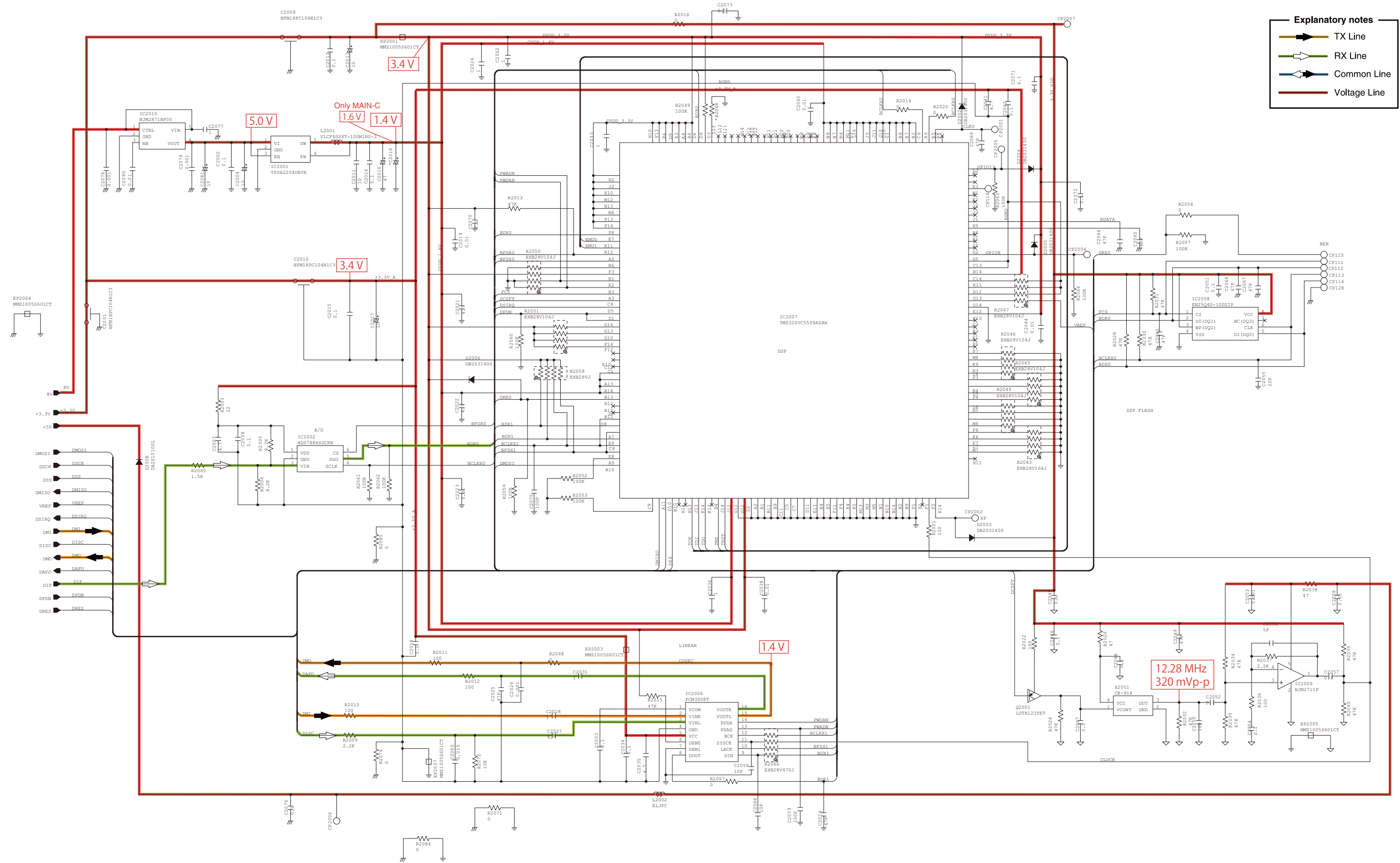

Explanatory notes

- TX Line
- RX Line
- Common Line
- Voltage Line

*: Refer to the PARTS LIST for the value and name of component.